

# ALBERTA PRIVATE SEWAGE SYSTEMS

STANDARD OF PRACTICE 2021





# **Alberta Private Sewage Systems Standard of Practice 2021**

Established by the  
Plumbing Sub-Council,  
Safety Codes Council  
October 2021

## **Copyright**

All rights reserved. No part of this book may be used or reproduced in any form or by any means without prior written permission of the Safety Codes Council.

Safety Codes Council - 500, 10405 Jasper Avenue, Edmonton, Alberta Canada, T5J 3N4  
(780) 413-0099 1-888-413-0099  
[www.safetycodes.ab.ca](http://www.safetycodes.ab.ca)



Published by the Safety Codes Council  
Fourth Edition - October 2021

## **Safety Codes Council - Plumbing Sub-Council**

---

The Safety Codes Council is a statutory corporation that administers parts of the *Safety Codes Act* in Alberta, including reviewing and formulating safety codes and standards. The Plumbing Sub-Council is one of the sub-councils that form the Safety Codes Council and, at the time of this document's approval, is responsible for all matters related to plumbing and private sewage systems. Following a peer review, the Plumbing Sub-Council establishes the content of the Private Sewage Systems Standard of Practice, which is adopted under the Private Sewage Disposal Systems Regulation.

A Working Group of experts established by the Plumbing Sub-Council developed this Standard of Practice. The Working Group is made up of industry, municipal, and academic stakeholders, with support from the Ministry of Municipal Affairs. Group members are drawn from the following stakeholder groups:

- **Academia and research**
- **Alberta Urban Municipalities Association**
- **Alberta Onsite Wastewater Management Association**
- **Association of Professional Engineers, Geologists and Geophysicists of Alberta**
- **Manufacturers of onsite wastewater equipment**
- **Plumbing Sub-Council**
- **Private Sewage Safety Codes Officers**
- **Private sewage system contractors**
- **Rural Municipalities of Alberta**
- **Work camp industry**

## Private Sewage Working Group

---

**Angus Potskin**  
Working Group Chair, Plumbing Sub-Council

**David Dallaire**  
Alberta Wilbert Sales

**Richard Tipple**  
RT Septic Systems Inc.

**Dan Morris**  
D&S Enterprises Wastewater Design

**Michael Schmalz**  
Stowell Pumps

**Barry Bohn, P.Eng.**  
Watertech Engineering Research and Health Inc.

**David Hughes**  
NAIT

**Lesley Desjardins**  
Alberta Onsite Wastewater Management Association

**Adel Carew**  
Blue Drop Solutions

**Ken Wigmore**  
Councillor, County of Lacombe

**Richard Stellmaker**  
Safety Codes Officer, Parkland County

**Angus Chu, P.Eng.**  
University of Calgary

**Brent Bowerman, P.Geol Hydrogeologist**  
Baseline Water Resource Inc.

## Alberta Municipal Affairs Support

---

**Dean Morin, P. Eng.**  
Administrator, Private Sewage

**Joseph Petryk, C.E.T**  
Acting Administrator, Private Sewage

**Stephen Hirose**  
Technical Advisor

**David G. Dobson**  
Technical Advisor

## Subject Matter Experts

---

**Dave Gustafson P. Eng.**  
Department Head  
University of Minneapolis St. Paul

**Kent Watson, MSc, BSc**  
International Remote Sensing Surveys Ltd.  
Associate Professor, Soils Science  
Thompson Rivers University (retired)

**Sara Heger, P. Eng.**  
University of Minneapolis St. Paul

**Bryer Manwell P. Eng., P. Geo.**  
Caulwell Consulting

**Steve Carballeira, P. Eng.**  
H2O Environmental

## Peer Review

---

**Sidney Manning**  
Administrator, Plumbing & Gas  
Alberta Municipal Affairs

**Steve Neff**  
Safety Codes Officer  
Leduc County

**Dave Lentz**  
Infiltrator Water Technologies

**Doug Everett**  
Alberta Health Services

**Lyndon Gyurek**  
Alberta Environment and Parks

**Charles Hallett**  
Director,  
Alberta Safety Codes Authority

## Table of Contents

<b>PART 1 SCOPE AND DEFINITIONS</b>	<b>1</b>
<b>Section 1.1. General</b>	<b>1</b>
1.1.1. Intent	1
1.1.2. Scope	1
1.1.3. Objectives	3
1.1.4. Interpretations	3
1.1.5. Definitions	4
1.1.6. Abbreviations	16
<b>PART 2 GENERAL REQUIREMENTS</b>	<b>17</b>
<b>Section 2.1. General System Requirements</b>	<b>17</b>
2.1.1. General System Requirements — Objectives and Design Requirements	17
2.1.2. General System Requirements — Prescriptive Requirements and Installation Standards	19
2.1.3. General System Requirements — Requirements for Materials	22
<b>Section 2.2. Wastewater Flow and Strength</b>	<b>23</b>
2.2.1. Wastewater Flow and Strength — Objectives and Design Requirements	23
2.2.2. Wastewater Flow and Strength — Prescriptive Requirements and Installation Standards	24
<b>Section 2.3. System Controls: System Flow Less than 5.7 Cubic Metres per Day</b>	<b>31</b>
2.3.1. System Controls: System Flow Less than 5.7 Cubic Metres per Day — Objectives and Design Requirements	31
2.3.2. System Controls: System Flow Less than 5.7 Cubic Metres per Day — Prescriptive Requirements and Installation Standards	32
2.3.3. System Controls: System Flow Less than 5.7 Cubic Metres per Day — Requirements for Materials	33
<b>Section 2.4. System Controls and Monitoring:   System Flow Greater than 5.7 Cubic Metres per Day</b>	<b>34</b>
2.4.1. System Controls: System Flow Greater than 5.7 Cubic Metres per Day — Objectives and Design Requirements	34
2.4.2. System Controls and Monitoring: System Flow Greater than 5.7 Cubic Metres per Day — Prescriptive Requirements and Installation Standards	36
2.4.3. System Controls and Monitoring: System Flow Greater than 5.7 Cubic Metres per Day — Requirements for Materials	36
<b>Section 2.5. Piping</b>	<b>37</b>
2.5.1. Piping — Objectives and Design Standards	37
2.5.2. Piping — Prescriptive Requirements and Installation Standards	37
2.5.3. Piping — Requirements for Materials	39
<b>Section 2.6. Pressure Distribution of Effluent</b>	<b>40</b>
2.6.1. Pressure Distribution — Objectives and Design Requirements	41
2.6.2. Pressure Distribution — Prescriptive Requirements and Installation Standards	42
2.6.3. Pressure Distribution — Requirements for Materials	43
<b>PART 3 HOLDING TANKS</b>	<b>45</b>
<b>Section 3.1. Holding Tanks</b>	<b>45</b>
3.1.1. Holding Tanks — Objectives and Design Standards	45
3.1.2. Holding Tanks — Prescriptive Requirements and Installation Standards	45
3.1.3. Holding Tanks — Requirements for Materials	46

<b>PART 4 INITIAL TREATMENT COMPONENTS PRIMARY</b>	<b>47</b>
<b>Section 4.1. Primary Treatment</b>	<b>47</b>
4.1.1. Primary Treatment — Objectives and Design Standards	47
<b>Section 4.2. Septic Tanks</b>	<b>48</b>
4.2.1. Septic Tanks — Objectives and Design Standards	48
4.2.2. Septic Tanks — Prescriptive Requirements and Installation Standards	49
4.2.3. Septic Tanks — Requirements for Materials	50
<b>PART 5 INITIAL TREATMENT COMPONENTS — SECONDARY TREATMENT</b>	<b>51</b>
<b>Section 5.1. Secondary Treatment</b>	<b>51</b>
5.1.1. Secondary Treatment — Objectives and Design Standards	51
<b>Section 5.2. Packaged Sewage Treatment Plants</b>	<b>53</b>
5.2.1. Packaged Sewage Treatment Plants — Objectives and Design Standards	53
5.2.2. Packaged Sewage Treatment Plants — Prescriptive Requirements and Installation Standards	54
5.2.3. Packaged Sewage Treatment Plants — Requirements for Materials	56
<b>Section 5.3. Secondary Treatment — Sand Filters</b>	<b>57</b>
5.3.1. Sand Filters — Objectives and Design Standards	57
5.3.2. Sand Filters — Prescriptive Requirements and Installation Standards	59
5.3.3. Sand Filters — Requirements for Materials	61
<b>Section 5.4. Secondary Treatment — Re-circulating Gravel Filters</b>	<b>64</b>
5.4.1. Re-circulating Gravel Filters — Objectives and Design Standards	64
5.4.2. Re-circulating Gravel Filters — Prescriptive Requirements and Installation Standards	65
5.4.3. Re-circulating Gravel Filters — Requirements for Materials	67
<b>PART 6 INITIAL TREATMENT COMPONENTS — EFFLUENT AND PRE-TREATMENT TANKS</b>	<b>69</b>
<b>Section 6.1. Effluent Tanks</b>	<b>69</b>
6.1.1. Effluent Tanks — Objectives and Design Standards	69
6.1.2. Effluent Tanks — Prescriptive Requirements and Installation Standards	70
6.1.3. Effluent Tanks — Requirements for Materials	71
<b>Section 6.2. Settling Tanks (Pre-Treatment)</b>	<b>72</b>
6.2.1. Settling Tanks — Objectives and Design Requirements	72
6.2.2. Settling Tanks — Prescriptive Requirements and Installation Standards	73
6.2.3. Settling Tanks — Requirements for Materials	74
<b>Section 6.3. Lift Stations</b>	<b>75</b>
6.3.1. Lift Stations — Objectives and Design Requirements	75
6.3.2. Lift Stations — Prescriptive Requirements and Installation Standards	76
6.3.3. Lift Stations — Requirements for Materials	76
<b>PART 7 SITE EVALUATION</b>	<b>77</b>
<b>Section 7.1. Site Characteristics and Evaluation Procedures</b>	<b>77</b>
7.1.1. Site Characteristics and Evaluation Procedures — Objectives and Design Standards	77
7.1.2. Site Characteristics and Evaluation Procedures — Prescriptive Requirements and Installation Standards	82

---

**TABLE OF CONTENTS**

---

<b>PART 8 GENERAL SOIL-BASED TREATMENT</b>	<b>83</b>
<b>Section 8.1. Soil-based Treatment</b>	<b>83</b>
8.1.1. Soil-based Treatment — Objectives and Design Standards	83
8.1.2. Soil-based Treatment — Prescriptive Requirements and Installation Standards	89
<b>Section 8.2. Treatment Fields</b>	<b>91</b>
8.2.1. Treatment Fields — Objectives and Design Standards	91
8.2.2. Treatment Fields — Prescriptive Requirements and Installation Standards	93
8.2.3. Treatment Fields — Requirements for Materials	97
<b>Section 8.3. Chamber System Treatment Fields</b>	<b>98</b>
8.3.1. Chamber System Treatment Fields — Objectives and Design Standards	98
8.3.2. Chamber System Treatment Fields — Prescriptive Requirements and Installation Standards	99
8.3.3. Chamber System Treatment Fields — Requirements for Materials	99
<b>Section 8.4. Treatment Mounds</b>	<b>100</b>
8.4.1. Treatment Mounds — Objectives and Design Standards	100
8.4.2. Treatment Mounds — Prescriptive Requirements and Installation Standards	104
8.4.3. Treatment Mounds — Requirements for Materials	106
<b>Section 8.5. Sub-surface Drip Dispersal and Irrigation</b>	<b>107</b>
8.5.1. Sub-surface Drip Dispersal and Irrigation — Objectives and Design Standards	107
8.5.2. Sub-surface Drip Dispersal and Irrigation — Prescriptive Requirements and Installation Standards	110
8.5.3. Sub-surface Drip Dispersal and Irrigation — Requirements for Materials	111
<b>Section 8.6. LFH At-grade Treatment Systems</b>	<b>112</b>
8.6.1. LFH At-grade Treatment Systems—Objectives and Design Standards	112
8.6.2. LFH At-grade Treatment Systems – Prescriptive Requirements and Installation Standards	115
8.6.3. LFH At-grade Treatment System — Material Requirements	117
<b>Section 8.7. Open Discharge Systems</b>	<b>118</b>
8.7.1. Open Discharge Systems— Objectives and Design Standards	118
8.7.2. Open Discharge — Prescriptive Requirements and Installation Standards	118
8.7.3. Open Discharge Systems — Requirements for Materials	119
<b>PART 9 EVAPORATIVE AND STORAGE LAGOONS</b>	<b>121</b>
9.1.1. Lagoons — Objectives and Design Standards	121
9.1.2. Lagoons — Prescriptive Requirements and Installation Standards	122
<b>PART 10 PRIVIES</b>	<b>123</b>
10.1.1. Privies — Objectives and Design Standards	123
10.1.2. Privies — Prescriptive Requirements and Installation Standards	123
10.1.3. Privies — Requirements for Materials	125
<b>APPENDIX A</b>	<b>127</b>
A.1. Pressure Distribution Lateral Pipe System Tables	128
A.1.A. Number of Orifices per distribution lateral pipe	128
A.1.B. Orifice Discharge Rates	132
A.1.C.1. Friction Loss in PVC Schedule 40 Pipe – Imperial & U.S. Gallons	136
A.1.C.2. Friction Loss in PVC Schedule 40 Pipe - Metric	137
A.1.C.3. Friction Loss in Polyethylene Pipe – Gallons	138
A.1.C.4. Friction Loss in Polyethylene Pipe - Metric	139
A.1.C.5. Friction Loss Equivalent Lengths for Fittings – Polyethylene Pipe	140
A.1.C.6. Friction Loss Equivalent Lengths for Fittings – Schedule 40 PVC Pipe	140
A.1.D.1. Liquid Volume of Pipes	140



A.1.E.1. Effluent Soil Loading Rates and Linear Loading Rates (Imp. gal.)	141
A.2. Lagoon System Design Data	143
A.2.A. Precipitation Rates	143
A.2.B. Evaporation Rates	144
A.2.C. Calculation of Lagoon Surface Area Requirements for Evaporation	145
A.2.D. Lagoon Volumes	146
A.3. Alberta Design Data	147
A.3.A. Alberta Climate Design Data by Town	147
A.3.B. Soil Clay Content Map	150
A.3.C. Soil Montmorillonite Content Map	151
A.4. Treatment Field Design Data	152
A.4.A. Disposal Field Loading Rates per Day and Sizes	153
A.5. Acceptable Piping Materials Table	154
A.5.A. Piping Materials	154
A.6. Septic Tank Sludge and Scum Accumulation Rates for Other Than Residential	155
A.6.A. Septic Tank Sludge and Scum Accumulation Rates	155
A.7. Conversion Factors	161
<b>APPENDIX B</b>	<b>163</b>
Legislative Application of the Standard and Related Legislation	164
Legislative Authority	164
<b>Explanations &amp; Related Articles for Part 1 – Scope and Definitions</b>	<b>165</b>
Section B-1.1. General	165
<b>Explanations &amp; Related Articles for Part 2 – General Requirements</b>	<b>174</b>
Section B-2.1. General System Requirements	174
Section B-2.2. Wastewater Flow and Strength	175
Section B-2.3. System Controls: System Flow Less than 5.7 Cubic Metres per Day	180
Section B-2.5. Piping	181
Section B-2.6. Pressure Distribution of Effluent	182
<b>Explanations &amp; Related Articles for Part 3 – Holding Tanks</b>	<b>185</b>
Section B-3.1. Holding Tanks	185
<b>Explanations &amp; Related Articles for Part 4 – Initial Treatment Components Primary</b>	<b>186</b>
Section B-4.1. Primary Treatment	186
Section B-4.2. Septic Tanks	187
<b>Explanations &amp; Related Articles for Part 5 Initial Treatment Components – Secondary Treatment</b>	<b>191</b>
Section B-5.2. Packaged Sewage Treatment Plants	191
Section B-5.3. Secondary Treatment – Sand Filters	195
Section B-5.4. Secondary Treatment – Re-circulating Gravel Filters	197
<b>Explanations &amp; Related Articles for Part 6 Initial Treatment Components – Effluent and Pre-treatment Tanks</b>	<b>198</b>
Section B-6.2. Settling Tanks (Pre-treatment)	198
<b>Explanations &amp; Related Articles for Part 7 Site Evaluation</b>	<b>200</b>
Section B-7.1. Site Characteristics and Evaluation Procedures	200
<b>Explanations &amp; Related Articles for Part 8 General Soil-based Treatment</b>	<b>202</b>
Section B-8.1. Soil-based Treatment	202
Section B-8.2. Treatment Fields	207
Section B-8.3. Chamber System Treatment Fields	211
Section B-8.5. Sub-surface Drip Dispersal and Irrigation	215
Section B-8.6. LFH At-grade Treatment Systems	217
<b>Explanations &amp; Related Articles for Part 10 Privies</b>	<b>223</b>



## Part 1 Scope and Definitions

### Section 1.1. General

#### 1.1.1. Intent

##### 1.1.1.1. Intent

- 1) The intent of this Standard is to set out performance objectives, design standards, prescriptive-based solutions and requirements for materials and equipment related to *on-site wastewater treatment system* designs regarding the<sup>1</sup>
  - a) initial treatment of *wastewater*,
  - b) final treatment of *wastewater* in *soil*,
  - c) containment of *wastewater* and treated *effluent*,
  - d) risk of contact with *wastewater* or treated *effluent*,
  - e) operational control of a system, and
  - f) structural adequacy of a system,

that will result in an *on-site wastewater treatment system* that reduces the risk to public health and the natural environment to a level that is deemed acceptable.

<sup>1</sup> Note: Sentence (1) – See Appendix B.1.1.1.1.

#### 1.1.2. Scope

##### 1.1.2.1. Application

- 1) This Standard establishes requirements for the design, installation, and site selection of on-site *wastewater* treatment systems that are defined further as<sup>1,2</sup>
  - a) including all components making up the *treatment system* starting at a point 1.8 m (6 ft.) upstream of the first component in the *wastewater* management and treatment system to the point where the *effluent* reaches the treatment boundary limit established for the system and includes any *wastewater* tanks or lift stations outside the *buildings*, but not including the *building drain* leaving the *building*;
  - b) including any portion of the on-site soils or imported soils used to achieve the required treatment performance;
  - c) including systems where *water re-use* for irrigation is included as a method to achieve the final treatment and return of the *wastewater* to the environment;<sup>3</sup>
  - d) including systems designed to contain *wastewater* in a safe manner until the *wastewater* can be removed and transported to another location for treatment and final disposition;
  - e) including earthen pit privies and vault privies as they relate to the management of the waste received but does not include
    - i) self-contained, portable privies, and
    - ii) any related structural components not required for the management of the *wastewater*;
  - f) not including systems used for the management of *wastewater* resulting from industrial processes or otherwise considered an industrial *wastewater*,<sup>4</sup> and
  - g) not including systems that discharge into a natural body of water or manmade body of water, other than a *wastewater* or *effluent lagoon* described in this Standard.<sup>5</sup>

<sup>1</sup> Note: Sentence (1) — Regulations adopting this Standard may set limits on the application of this Standard under that regulation as it applies to the volume of wastewater generated by the development or limitations regarding the use of systems following this Standard based on larger scale cumulative loading impacts. Reference to the applicable legislation is required for the proper application of this Standard.

<sup>2</sup> Note: See Appendix B-1.1.2.1.

<sup>3</sup> Note: Clause (1)(c) — Such systems would include irrigation where the effluent is utilized for a beneficial purpose but is ultimately returned to the environment through the soil to achieve final treatment.

<sup>4</sup> Note: Clause (1)(f) - See Appendix B-1.1.2.1.(1)(f)

<sup>5</sup> Note: Clause (1)(g) - See Appendix B-1.1.2.1.(1)(g)

2) This Standard includes specific requirements for *common on-site wastewater treatment systems* that fall within the following broad categories:<sup>1</sup>

- a) systems serving residential and commercial developments that generate
  - i) up to 5.7 m<sup>3</sup> (1,250 Imp. gal.) per day of *wastewater* volume, and
  - ii) *wastewater* of a strength equal to or less than *typical wastewater*,
- b) pit privies and vault privies.

<sup>1</sup> Note: Sentence (2) – See Appendix B-1.1.2.1.(2)

3) This Standard includes specific requirements for *complex on-site wastewater treatment systems* that fall within the following broad categories:

- a) systems serving residential and commercial developments that generate up to 5.7 m<sup>3</sup> (1,250 Imp. gal.) per day of *wastewater* volume, and
  - i) the *wastewater* is of a strength greater than *typical wastewater*, or
  - ii) where treatment objectives require a disinfection or nutrient reduction component in the treatment train;
- b) systems serving developments that generate more than 5.7 m<sup>3</sup> (1,250 Imp. gal.) of *wastewater* per day; and
- c) systems that employ *effluent water re-use* for irrigation as a method of returning it to the environment.

4) This Standard sets out specific requirements for

- a) *holding tanks* and *septic tanks*,
- b) *packaged sewage treatment plants*,
- c) *treatment fields*,
- d) *treatment mounds*,
- e) *LFH At-grade systems*,
- f) *open discharge systems*,
- g) *wastewater* or *effluent lagoons*,
- h) sand filters,
- i) *gravel filters*, and
- j) pit privies and vault privies.

5) This Standard does not include or establish requirements related to administrative programs needed for the effective overall management of *on-site wastewater treatment systems*.

- 6) This Standard sets out acceptable system designs and *effluent* treatment standards suitable for general use in Alberta.
- 7) This Standard sets requirements suitable for the design of *private sewage systems* in Alberta but does not set out the additional requirements for, or provide direction on, the selection of the type of *on-site wastewater treatment system* and required *effluent* quality that may be needed to manage cumulative impacts from nitrogen or phosphorus loading present in the *wastewater*
  - a) on a multi-lot/subdivision scale or water shed scale caused by multiple or large *on-site wastewater treatment systems*, or
  - b) where systems are located in a sensitive receiving environment.<sup>1,2</sup>

<sup>1</sup> Note: Clause (b) — The determination of treatment objectives, effluent quality and system types required for a development may need to consider any cumulative impact or loading limits established under other legislation. Loading limits required to prevent unacceptable impacts on groundwater or surface water, caused by the total wastewater generated from multi-lot subdivisions or where needed to protect a sensitive receiving environment, need to be considered in the selection and use of on-site wastewater treatment systems.

<sup>2</sup> Note: Sentence (7)(b) - See Appendix B-1.1.2.1.(7) (b)

### **1.1.3. Objectives**

#### **1.1.3.1. General**

- 1) The objective of an *on-site wastewater treatment system* is to treat *wastewater* and return it to the environment so that
  - a) risks to health are not created,
  - b) the impact on ground and surface waters is minimized, and
  - c) the environment is not harmed.

### **1.1.4. Interpretations**

#### **1.1.4.1. Supplementary Information**

- 1) Intent statements, notes, and warning statements are included to provide additional information regarding specific requirements.

#### **1.1.4.2. Liability**

- 1) This Standard does not provide or imply any assurance or guarantee about the life expectancy, durability, operating performance, or workmanship of the equipment, materials, or undertaking.

#### **1.1.4.3. Units of Measurement**

- 1) Metric units of measure are the official measurement used in this Standard with approximate imperial equivalents provided in brackets for user convenience.

#### 1.1.4.4. Numbering

1) The numbering system in this Standard uses the following format:

2	Part,
2.5.	Section,
2.5.1.	Subsection,
2.5.1.1.	Article,
2.5.1.1.(1)	Sentence,
2.5.1.1.(1)(c)	Clause,
2.5.1.1.(1)(c)(i)	Subclause.

#### 1.1.5. Definitions

##### 1.1.5.1. Interpretation of Words and Phrases

1) Words and phrases used in this Standard that are not included in the list of definitions shall have the meanings that are commonly assigned to them in the context in which they are used in this Standard, taking into account the specialized use of terms by the trades and professions to which the terminology applies.<sup>1</sup>

<sup>1</sup> Note: Sentence (1) – See Appendix B-1.1.5.1.(1)

2) Words and phrases regarding soils and soil characteristics used in this Standard, including defined terms, shall be interpreted and used in a manner consistent with definitions established under the Canadian System of Soil Classification.<sup>1</sup>

<sup>1</sup> Note: Sentence (2) – Canadian System of Soil Classification definitions can be used to gain more description of the terms and direction on how to identify and classify soils. Additional and more detailed definitions can also be found in the Canadian Soil Information System (CanSIS) Manual for Describing Soils in the Field.

##### 1.1.5.2. Defined Terms

1) Italicized words and terms in this Standard shall have the following meanings:

***Administrator*** - an *Administrator* appointed pursuant to Section 14 of the Safety Codes Act.

***Aquifer*** - any porous water-bearing geologic formation capable of yielding a supply of water.

***Aquifer, Domestic Use*** - (DUA) a geologic unit (either of a single lithology or inter-bedded units) that is above the Base of Groundwater Protection and has one or more of the following properties:

- a bulk hydraulic conductivity of  $1 \times 10^{-6}$  m/s or greater and sufficient thickness to support a sustained yield of 0.76 L/min or greater,
- is currently being used for domestic purposes, or
- is any aquifer determined by Alberta Environment to be a DUA.<sup>1</sup>

<sup>1</sup> Note: While it is possible that peat deposits and muskeg may meet the definition of a DUA, based on hydraulic conductivity and unit thickness, Alberta Environment generally does not consider peat deposits or muskeg to be a DUA because groundwater in them is unlikely to be used as a domestic source. (See Appendix B-1.1.5.2. *Aquifer, Domestic Use*).

***Authority having jurisdiction (AHJ)*** – the governmental body or designated agency responsible for the enforcement of any part of the Standard of Practice.

**Berm** - the prescribed above *grade* fill material of a *treatment mound*, sand filter, or raised *treatment field*. The raised freeboard area around a *lagoon* or the positive *grade* around a privy.

**Biochemical oxygen demand (BOD<sub>5</sub>)** - the amount of oxygen (expressed as mg/L) utilized by micro-organisms in the oxidation of organic matter during a 5-day period at a temperature of 20°C (68°F). This measure is typically used for raw *wastewater* samples. (See Appendix B-1.1.5.2. *biochemical oxygen demand (BOD<sub>5</sub>)*).

**Building** - any structure used or intended for supporting or sheltering any use or occupancy that is regulated by the NBC-AE, but does not include *buildings* of low occupancy associated with the operation of a farm on which it is located, where the *building* is used for the: housing of livestock, storage of maintenance equipment, storage of materials or produce.<sup>1</sup>

<sup>1</sup> Note: See definition of farm building.

**Building drain** - the lowest horizontal piping, including any vertical offset, that conducts *sewage*, clear-water waste, or *storm water* by gravity to a *building sewer*.<sup>1</sup>

<sup>1</sup> Note: as the building sewer starts 1 m (3.25 ft.) outside the building, the building drain then ends at a point 1 m (3.25 ft.) outside the building.

**Building sewer** - a pipe connected to a *building drain* starting 1 m (3.25 ft.) outside a wall of a *building* and that connects to a public sewer or *on-site wastewater treatment system*.<sup>1</sup>

<sup>1</sup> Note: the building sewer needs to be installed as per the National Plumbing Code of Canada.

**Carbonaceous biochemical oxygen demand (cBOD<sub>5</sub>)** - the amount of oxygen (expressed as mg/L) utilized by micro-organisms in the non-nitrogenous oxidation of organic matter in *wastewater* during a 5-day period at a temperature of 20°C (68°F). This measure is typically used for effluent samples. (See Appendix 1.1.5.2. Carbonaceous biochemical oxygen demand (cBOD<sub>5</sub>)).

**Certified** - investigated and identified by a designated testing organization as conforming to recognized standards, requirements, or test reports as set out in this standard or acceptable to the *Administrator*.

**Clearwater waste** - *wastewater* with impurity levels that will not likely be harmful to a person's health but is not considered potable. (See Appendix B-1.1.5.2. *clearwater waste*)

**Coarse-fragment** - mineral particles in the *soil* that exceed 2.00 mm in *diameter*.

**COLE (Coefficient Of Linear Extensibility)** - the percentage decrease in the length of a bar of *soil* formed from a disturbed *soil* sample at its liquid limit (saturation limit) after being dried in an oven. (See Appendix B-1.1.5.2. COLE (Coefficient Of Linear Extensibility)).

**Common on-site wastewater treatment system** – typically a system that serves a residential or commercial development that generates up to 5.7 m<sup>3</sup> (1,250 Imp. gal.) per day of *wastewater* and has a *typical wastewater* strength.

**Complex on-site wastewater treatment system** – typically a system that serves a residential or commercial *development* that generates more than 5.7 m<sup>3</sup> (1,250 Imp. gal.) per day of *wastewater* where the *wastewater* strength is greater than *typical wastewater* strength, where considerations are needed for disinfection, nutrient reduction, irrigation or other advanced design requirements.<sup>1</sup>

<sup>1</sup> *Note: Complex system design shall only be undertaken and completed by a Professional Engineer, or other persons with qualifications suitable to the Administrator. Persons with qualifications suitable to the Administrator shall have written acknowledgement of acceptance of qualification from the Administrator. Notwithstanding this definition, the complex system design can incorporate design information from others provided there is a single overall responsible designer for the complex system. (See Appendix B-1.1.5.2. Complex On-site Wastewater Treatment System for additional clarification.)*

**Consistence** - an attribute of *soil* expressed in degree of cohesion and adhesion, or in resistance to deformation or rupture. *Consistence* includes: the resistance of *soil* material to rupture; resistance to penetration; the plasticity, toughness, or stickiness of puddled *soil* material; and the manner in which the *soil* material behaves when subjected to compression. Classifications of moist *soil consistence* include loose, very friable, friable, firm, very firm, and extremely firm. (See Appendix B-1.1.5.2. Consistence)

**Cumulative impact** - the total impact attributable to numerous individual influences.

**Development** - *buildings* or other constructed facilities.

**Diameter** - unless otherwise indicated, the nominal *diameter* by which a pipe, fitting, trap, or other item is commercially designated.

**Distribution header** - a non-perforated pipe, receiving *effluent* from the *effluent sewer* or *effluent line*, which distributes *effluent* by pressure or gravity to more than one *effluent distribution lateral pipe*, *weeping lateral pipe*, or *weeping lateral trench*.

**Distribution lateral pipe** - a perforated pressurized pipe used to evenly distribute *effluent* throughout the entire length of a *weeping lateral trench* or over a surface area in a sand filter or *treatment mound*. (See Appendix B-1.1.5.2. *distribution lateral pipe*)

**Drain media** - clean washed *gravel*, clean crushed rock, or other media into which *effluent* is distributed or used to collect *effluent* below treatment filter media and which meets the specific material requirements set out in this Standard for its specific purpose.

**Dwelling** or **Dwelling unit** - a suite operated as a housekeeping unit that is used or intended to be used as a domicile by one or more persons and usually contains cooking, eating, living, sleeping, and sanitary facilities.

**DWV pipe** - a class of piping *certified* for use in a plumbing system for use as drain, waste, and venting piping.

**Effluent** - the liquid discharged from any initial treatment component into any downstream *wastewater* treatment component.

**Effluent chamber** - a chamber within a tank that receives and stores *effluent* (from which *effluent* is periodically discharged into the downstream components of the treatment system). Also called a dose tank.

**Effluent tank** - an independent tank that receives and stores *effluent* (from which *effluent* is periodically discharged into the downstream components of the treatment system). Also called a dose tank.

**Effluent hydraulic linear loading** - the cumulative total of *effluent* applied to the *soil* profile below a *soil-based treatment area*, expressed as volume per unit length per unit time, e.g., litres per day per lineal metre, along the axis of the *soil-based treatment area* that is oriented at 90 degrees to the assumed direction of subsurface flow (typically this is consistent with surface slope direction). (See Appendix B1.1.5.2., Effluent Hydraulic Linear Loading.)



**Effluent hydraulic loading rate** - the quantity of *effluent* applied to a given treatment component, usually expressed as volume per unit of infiltrative surface area per unit time, e.g., liters per day per square metre (Lpd/m<sup>2</sup>) or imperial gallons per day per square foot (gpd/ft<sup>2</sup>).

**Effluent line** - piping for the flow of *effluent* under pressure and supplied by a pump. (See Appendix B-1.1.5.2., Effluent Line)

**Effluent sewer** - piping for the flow of *effluent* through the action of gravity. (See Appendix B-1.1.5.2., Effluent Sewer.)

**Equalization tank** - a tank that provides storage of *wastewater* or *effluent* to enable timed dosing by pumps to manage flow variations, resulting in a more uniform delivery of *wastewater* or *effluent* to a subsequent component over time, usually a day or more; also known as a surge tank.

**Farm building** – a *building* located on agricultural land as defined in the Agricultural Operation Practices Act that is occupied for an agricultural operation as defined in the Agricultural Operation Practices Act, including but not limited to, housing livestock, storing, sorting, grading, or bulk packaging of agricultural products that have not undergone secondary processing and housing storing or maintaining machinery that is undertaken in the *building*.<sup>1,2</sup>

<sup>1</sup> Note: See definition of *building*.

<sup>2</sup> Note: Some farm buildings are considered commercial with high human occupancy and the NBC-AE does apply.

**Field capacity** - the maximum amount of water that can be held by a *soil* without draining by gravity. (See Appendix B-1.1.5.2., Field Capacity.)

**Field header** - a main gravity *weeping lateral pipe* that also distributes *effluent* to other weeping lateral pipes in a *treatment field* where all weeping lateral trenches and the *distribution header* are at the same elevation and level.

**Fines** - particles that can pass through a 0.15mm (0.0059 in.) No. 100 sieve.

**Geotextile fabric** – a non-woven material used to impede or prevent the movement of sand, silt, and clay into the spaces between larger media but does not impede the movement of air or water.

**Gleyed** - a characteristic of a *soil* that has undergone gleysation, a *soil*-forming process that occurs under poor drainage conditions and results in redoximorphic features (the reduction of iron and other elements and in bluish, greenish or gray *soil* colours, and/or rust or gray coloured mottles). It is indicative of soils that are saturated or waterlogged for significant periods of time, which limits the suitability of *soil* for an *effluent* treatment system. See the Canadian Soil Information System for a more definitive definition and further information on identifying *gleyed* soils. (See Appendix B-1.1.5.2., Gleyed.)

**Grade** -

- a) in relation to *soil* characteristics, the degree of visual distinctness and cohesion of *soil* aggregates into pedes expressed as *grade*: single grained structureless or massive (0), weak (1), moderate (2), or strong (3), or (See Appendix B-1.1.5.2., Grade.)
- b) in relation to an elevation on the landscape, the upper surface of the ground.

**Gravel** - see *drain media*

**Greywater** - *wastewater* that does not include waste from toilets or urinals, and that must be effectively managed and treated in accordance with this Standard.

**Groundwater mounding** - the rise in elevation of the seasonally saturated *soil*, regional *water table* or the creation of a perched *water table* below the *soil-based treatment area* resulting from the addition of *effluent* to the *soil*. (See Appendix B-1.1.5.2., Groundwater Mounding.)

**Groundwater Under the Direct Influence of Surface Water (GWUDI)** - groundwater having incomplete/undependable subsurface filtration of surface water and infiltrating precipitation.<sup>1</sup>

<sup>1</sup> Note: Refer to the Alberta Environment document entitled "Assessment Guideline for Groundwater Under the Direct Influence of Surface Water (GWUDI)" for determining whether a groundwater source is GWUDI. (See Appendix B-1.1.5. Groundwater Under the Direct Influence of Surface Water (GWUDI))

**Holding tank** - a tank designed to retain *wastewater* until removed by mobile equipment and transferred to an approved facility or location.

**Infiltration** -

- a) entry of water or *effluent* into the *soil*;
- b) entry of water or *effluent* onto a filter media;
- c) undesirable inflow or seepage of water into a system component, for example, *infiltration* of surface water into a tank through a leaking pipe or through an access riser/tank joint that is not watertight.

**Lagoon** – a designed earthen *structure* for the storage, treatment, and stabilization of *wastewater* or *effluent*.

**LFH At-grade system** - a *system* for the dispersal and final treatment of *effluent* that

- a) is located in a well-established forested area having a substantial LFH (litter, fermented, humic) layer;
- b) has a pressurized *effluent distribution lateral pipe system* that is placed on the surface of the undisturbed forest floor inside a chamber; and
- c) has wood chips, or other material that is suited to the ecology of the forest, covering the chambers.

(See Appendix B-1.1.5.2., LFH At-grade System)

**Lift station** - a tank-and-pump assembly used for the prime purpose of lifting *sewage* to a higher elevation and discharging it into other parts of the *on-site wastewater treatment system*. (See Appendix B-1.1.5.2. Lift Station.)

**Limiting condition** - *soil* or site characteristic that reduces the efficiency of *effluent* treatment in the *soil* or reduces hydraulic conductivity and thus restricts design options for a *system*. (See Appendix B-1.1.5.2. Limiting Condition.)

**Linear loading** - (See *effluent hydraulic linear loading*).

**Mobile soil water content** - the amount of water held in a *soil* between the *soil's field capacity* and the hygroscopic water holding ability of the *soil*, that is displaced as additional water is added to the *soil* volume. (See Appendix B-1.1.5.2., Mobile Soil Water Content.)

**Mottling** - a *soil* zone of chemical oxidation and reduction activity, appearing as splotchy patches of red, brown, orange, or gray in the *soil*, that may indicate the presence of a *water table*. (See Appendix B-1.1.5.2., Mottling.)

**Nominally level** - level, so as to not affect the performance of the system.

**On-site wastewater treatment system** - a system for the management and/or treatment of *wastewater* at or near the *development* that generates the *wastewater*, including that portion of the *building sewer* 1.8 m (6 ft.) upstream of any on-site *lift station*, *equalization tank*, *settling tank*, *septic tank*, packaged sewage treatment plant, *holding tank*, or *berm* of a *sewage lagoon*, and includes the final *soil*-based *effluent* dispersal and treatment system but does not include the plumbing *building drain* from the *development*, which ends 1 m (3.25 ft.) outside a *building*.<sup>1</sup>

<sup>1</sup> Note: See definitions for common on-site wastewater treatment system and complex on-site wastewater treatment system. For a broader description of the common and complex system, see Article 1.1.2.1.

**Open discharge system** - a system designed to discharge *effluent* to the ground surface to accomplish evaporation and absorption of the *effluent* into the *soil* as a method of treatment.

**Organic loading** - the total mass loading per unit of area per unit of time based on the *cBOD<sub>5</sub>* concentration in the *effluent*, multiplied by the volume of *effluent* applied over a given time, e.g., grams of *cBOD<sub>5</sub>*/m<sup>2</sup>/day.

**Packaged sewage treatment plant** - a manufactured unit that is used to substantially improve the *effluent* quality beyond the quality of *effluent* expected of a *septic tank*.

**Packed bed filter** - a container(s) packed with a filter media that receives *effluent* from an *effluent* distribution system to achieve the aerobic, biological, and physical treatment of *wastewater* as it passes through and comes in contact with the filter media.

**Parcel** - has the same meaning as property, as defined in this standard, which is also the same meaning as set out in Section 616 of the Municipal Government Act

**Particle size analysis** - establishing the percentage of sand, silt, or clay particles in a *soil* sample by of a standard hydrometer method and sieve analysis, as set out in the Canadian Soil Information System (CanSIS Analytical Methods Manual 1984 or other more recent and equivalent method recognized in the *soil* sciences). (See Appendix B-1.1.5.2., Particle Size Analysis.)

**Percolation test** - a procedure to estimate the rate the *soil* can accept and move clean water in saturated flow conditions. (See Appendix B1.1.5.2., Percolation Test.)

**Potable** - suitable for human consumption.

**Pressure distribution** – the application of *effluent* by means of an *effluent* pump to achieve uniform distribution of *effluent* throughout the downstream *soil based treatment system*, excluding the supply line.

**Pressure head** - the pressure existing in a fluid expressed as the height of a column of water that would exert an equal pressure.

**Primary treatment** - physical treatment processes involving removal of particles, typically by settling and flotation with or without the use of coagulants; (e.g. a *septic tank* provides primary treatment).

**Private sewage system** - (See *on-site wastewater treatment system*).

**Primary treated effluent** or **primary treated effluent Level 1 - effluent** that

- a) 80% of the time has
  - i) cBOD<sub>5</sub> of less than 150 mg/L,
  - ii) TSS of less than 100 mg/L, and
  - iii) oil and grease content of less than 15 mg/L, and
- b) does not exceed
  - i) cBOD<sub>5</sub> of 230 mg/L,
  - ii) TSS of 150 mg/L, and
  - iii) oil and grease content of 30 mg/L.

**Privy** - a small structure having a toilet pedestal, or bench with a hole or holes, through which human excrement is deposited into an excavated pit or watertight *holding tank*.

**Property** - the land described in the Certificate of Title issued under the Land Titles Act.

**Re-circulating gravel filter** - a system where *effluent* is re-circulated through filter media a number of times on an intermittent basis before being discharged for additional treatment or into a final treatment and dispersal system. (This design is often used to treat higher strength *wastewater*. It is sometimes referred to as a “re-circulating sand filter” in the industry.)

**Restricting condition** or **restrictive condition** - a *soil horizon*, *soil layer*, other conditions in the *soil profile* and underlying strata that restricts the downward movement of fluids that could cause a perched *water table*; saturated *soil* under the *soil infiltration surface* of the system; highly permeable layer which will reduce treatment effectiveness; unsuitable *soil* structures in combination with *soil* properties and other *soil* properties. (See Appendix B-1.1.5.2., Restricting Condition or Restrictive Condition.)

**Sand filter** - a *single-pass sand filter* that is intermittently dosed and that uses specifically graded sand or other media as the media for filtration and treatment of *effluent*.

**Sand filter media** - the granular filter media used in a sand filter for the treatment of the *effluent*.

**Sand filter surface area** - the area of the level plane section of the *sand filter media* receiving the *effluent* immediately below the *drain media* or chambers containing the pressurized *effluent* distribution piping.

**Sand layer** (when referring to a *treatment mound*) - the required depth and area of specifically graded sand that will receive the *effluent* distributed through a *gravel* bed or chambers located immediately above the sand layer.

**Seasonally saturated soil** - a *soil* that is saturated by a periodic high *water table* and is identified by the presence of *mottling* or *gleying* in the *soil*.

**Secondary treated effluent** - *effluent* that at least 80% of the time meets the *effluent* quality parameters set out in Table 5.1.1.1 for secondary treated *effluent* Levels 2, 3, or 4. (See Appendix B-1.1.5.2., Secondary Treated Effluent.)

**Sensitive receiving environment (SRE)** – a geographic area where there may be significant risk of degradation from the use of an *on-site wastewater treatment system*. Examples of a SRE include but not limited to: lakes, rivers, streams, or creeks that support the natural habitats of wildlife or developments where cumulative impacts from nitrogen and phosphorus loading may need to be managed.<sup>1</sup>

<sup>1</sup> Note: The determination of the SRE may require the cooperative input and assessment of the authority having jurisdiction, the safety codes officer, certified installer/designer, and regulatory bodies.

**Septic tank** - a tank with an integral chamber(s) used to provide primary treatment Level 1 of *wastewater* through the process of settling and floating of solids and in which digestion of the accumulated sludge occurs. (See Appendix B-1.1.5.2. Septic Tank.)

**Serial distribution** - a *treatment field* design where discharged *effluent* is forced to travel through one *weeping lateral trench* to get to another *weeping lateral trench*.

**Settling tank** - a tank, or chamber within a tank, that typically has a limited retention time and is installed upstream of a *packaged sewage treatment plant* or other initial treatment system and is intended for the removal of larger items or inorganic material in the *wastewater* stream and may also provide some level of treatment and anaerobic digestion (sometimes referred to as a “trash tank”).

**Sewage** - (see *wastewater*).

**Shore** - the edge of a body of water; includes the land adjacent to a body of water that has been covered so long by water as to wrest it from vegetation, or as to mark a distinct character on the vegetation where it extends into the water or on the *soil* itself. (See Appendix B-1.1.5.2., Shore.)

**Single-pass sand filter** - a system in which the *effluent* is applied on an intermittent basis and flows through the filter only once before being discharged for additional treatment or final dispersal.

**Size** - unless indicated otherwise, the nominal *size* by which a pipe, fitting, trap, or other item is commercially designated.

**Slope of land** - a landscape form or feature demonstrating a change in elevation; typically described as a percentage (amount of rise divided by amount of run multiplied by 100).

**Smectitic or Smectitic soil** - a *soil* that has characteristics significantly influenced by smectite clays, which are a group of 2:1 layer silicates with a high cation exchange capacity, about 110 cmol/kg *soil* smectites, and variable interlayer spacing; formerly called the montmorillonite group. The group includes dioctahedral members (montmorillonite, beidellite, and nontronite) and trioctahedral members (saponite, hectorite, and sauconite). (See Appendix B-1.1.5.2. Smectitic or Smectitic Soil.)

**Sodium Adsorption Ratio (SAR)** - a ratio of sodium, calcium, and magnesium that is used to express the relative activity of sodium ions in exchange reactions with *soil*. *Effluent* having a high SAR leads to a breakdown in the physical *structure* of the *soil* in *smectitic soils*.

**Soil** - a naturally occurring, unconsolidated mineral or organic material at the earth’s surface that is capable of supporting plant growth. Its properties usually vary with depth and are determined by climatic factors and organisms, as conditioned by relief and hence water regime, acting on geologic materials and producing genetic horizons that differ from the parent material.

**Soil colour** - colour features of a *soil* that indicate *soil* formation processes and conditions. The colours are indicators of the level of aerobic conditions of the *soil*, which is important to *wastewater* treatment in the *soil*. The Munsell Colour System is the method used to define and communicate the colours of the *soil*.

**Soil horizon** - a layer of *soil* or *soil* material approximately parallel to the land surface; it differs from adjacent genetically related layers in properties such as colour, *structure*, *texture*, *consistence*, and chemical, biological, and mineralogical composition.

**Soil infiltration surface** - the surface of *soil* receiving *effluent* for final treatment but does not include the *infiltration* surface of an engineered media or *soil* intended to improve the quality of the *effluent* prior to *infiltration* in to the *soil* for final treatment, such as the *sand layer* in a *treatment mound*. (See Appendix B-1.1.5.2., Soil Infiltration Surface.)

**Soil separates** - has the following 3 categories:

- a) Sand *soil* particles of a *size* between 0.05–2 mm.
- b) Silt *soil* particles of a *size* between 0.002– <0.05 mm.
- c) Clay *soil* particles of a *size* smaller than 0.002 mm.

(See Appendix B-1.1.5.2., Soil Separates.)

**Soil structure** or **Structure** - the combination or arrangement of primary *soil* particles into secondary units or *pedes*; secondary units are characterized on the basis of shape, size, class, and *grade* (degree of visual distinctness and cohesion of *soil* aggregates into *pedes* expressed as: single grained structureless or massive (0), weak (1), moderate (2), or strong (3)).

**Soil texture classification** or **Texture** - the relative proportions of the various *soil separates* in a *soil* (sand, silt, clay) and is described with the following *soil* textural classes and sub-classes:

- a) Sand - *soil* material that contains 85% or more sand; the percentage of silt plus 1.5 times the percentage of clay does not exceed 15; sand has the following sub-classes:
  - i) Coarse sand - 25% or more very coarse and coarse sand, and less than 50% any other one *grade* of sand. Coarse sand has a *size* limit that ranges between 1.0 to 0.5 mm. Very coarse sand has a *size* limit that ranges between 1.0 to 2.0 mm.
  - ii) Medium sand - 25% or more very coarse, coarse, and medium sand, and less than 50% fine or very fine sand. Medium Sand has a *size* limit that ranges between 0.5 and 0.25 mm.
  - iii) Fine sand - 50% or more fine sand or less than 25% very coarse, coarse, and medium sand and less than 50% very fine sand. Fine sand has a *size* limit that ranges between 0.25 and 0.10 mm.
  - iv) Very fine sand - 50% or more very fine sand. Very fine sand has a *size* limit that ranges between 0.10 to 0.05 mm.
- b) Loamy sand - *soil* material that contains at the upper limit 85 to 90% sand, and the percentage of silt plus 1.5 times the percentage of clay is not less than 15; at the lower limit it contains not less than 70 to 85% sand, and the percentage of silt plus twice the percentage of clay does not exceed 30; loamy sand has the following sub-classes:
  - i) Loamy coarse sand - 25% or more very coarse and coarse sand and less than 50% any other one *grade* of sand.
  - ii) Loamy medium sand - 25% or more very coarse, coarse, and medium sand and less than 50% fine or very fine sand.
  - iii) Loamy fine sand - 50% or more fine sand or less than 25% very coarse, coarse, and medium sand and less than 50% very fine sand.
  - iv) Loamy very fine sand - 50% or more is very fine sand.

- c) Sandy loam - *soil* material that contains either 20% or less clay, with a percentage of silt plus twice the percentage of clay that exceeds 30, and 52% or more sand; or less than 7% clay, less than 50% silt, and between 43% and 52% sand; sandy loam has the following sub-classes:
- i) Coarse sandy loam - 25% or more very coarse and coarse sand and less than 50% any other one *grade* of sand.
  - ii) Medium sandy loam - 30% or more very coarse, coarse, and medium sand, but less than 25% very coarse sand, and less than 30% very fine sand or fine sand.
  - iii) Fine sandy loam - 30% or more fine sand and less than 30% very fine sand or between 15 and 30% very coarse, coarse sand, and medium sand.
  - iv) Very fine sandy loam - 30% or more very fine sand or more than 40% fine sand and very fine sand, at least half of which is very fine sand, and less than 15% very coarse, coarse sand, and medium sand.
- d) Loam - *soil* material that contains 7 to 27% clay, 28 to 50% silt, and less than 52% sand.
- e) Silt loam - *soil* material that contains 50% or more silt and 12 to 27% clay, or 50 to 80% silt and less than 12% clay.
- f) Silt - *soil* material that contains 80% or more silt and less than 12% clay. Silt has a *size* limit that ranges from 0.05 to 0.002 mm.
- g) Sandy clay loam - *soil* material that contains 20 to 35% clay, less than 28% silt, and 45% or more sand.
- h) Clay loam - *soil* material that contains 27 to 40% clay and 20 to 45% sand.
- i) Silty clay loam - *soil* material that contains 27 to 40% clay and less than 20% sand.
- j) Sandy clay - *soil* material that contains 35% or more clay and 45% or more sand.
- k) Silty clay - *soil* material that contains 40% or more clay and 40% or more silt.
- l) Clay - *soil* material that contains 40% or more clay, less than 45% sand, and less than 40% silt. Clay has a *size* limit that is less than 0.002 mm.
- m) Heavy clay - *soil* material that contains more than 60% clay.

(See Appendix B-1.1.5.2., Soil Texture Classification or Texture.)

**Soil-based treatment area** or **Soil-based treatment system** - the physical location and area where the dispersal of *effluent* into the *soil* and final treatment of the *effluent* in the *soil* occurs.

**Specific surface waters** – a lake, river, stream or creek.

**Storm water** - water discharged from a surface as a result of rainfall or melting snowfall.

**Subsoil foundation drainage pipe** - a piping system that is installed underground to intercept and convey subsurface water away from a foundation.

**Total suspended solids (TSS)** - the dispersed particulate matter in a *wastewater* sample that may be retained by a filter medium. Suspended solids may include both settleable and unsetttable solids of both inorganic and organic origin. This parameter is widely used to monitor the performance of the various stages of *wastewater* treatment, and is often used in conjunction with BOD<sub>5</sub> and cBOD<sub>5</sub> to describe *wastewater* strength.

**Treatment boundary limits** - the limits of the treatment zone in the *soil* as defined by this Standard and as used in a design, such as the *vertical separation* depth required below an infiltrative surface that *effluent* is applied over and at the point the design requires or expects treatment to be achieved. (See Appendix B-1.1.5.2., Treatment Boundary Limits.)

**Treatment field** - a system of *effluent* dispersal and treatment by distributing *effluent* within trenches containing void spaces that are covered with *soil* and includes the following types:

- a) conventional *treatment field* - a system of *effluent* dispersal and treatment utilizing perforated piping laid in a bed of *gravel* in trenches for distributing *effluent* within the trenches;
- b) chamber *system treatment field* - a system of *effluent* dispersal and treatment using preformed structures to provide a void space for storage and movement of *effluent*, and an interface with the exposed infiltrative surface of the *soil*;
- c) *gravel substitute treatment field* - a conventional *treatment field*, in which the *gravel* is replaced with an alternate media having characteristics that will provide void space and performance similar to *gravel*; and
- d) raised *treatment field* - any of the above variations of treatment fields where *soil* is imported to enable all or a portion of the *treatment field* trench to be located above the in situ *soil* surface.

**Treatment mound** or **Mound** - a system where the *effluent* is distributed onto a sand layer and is built above *grade* to overcome limits imposed by depth to seasonally saturated *soil* or bedrock, or by highly permeable or impermeable soils.

**Typical wastewater** - wastewater that<sup>1</sup>

- a) 80% of the time has
  - i) BOD<sub>5</sub> of less than 220 mg/L,
  - ii) TSS of less than 220 mg/L, and
  - iii) oil and grease content of less than 50 mg/L, and
- b) does not exceed
  - i) BOD<sub>5</sub> of 300 mg/L,
  - ii) TSS of 350 mg/L, and
  - iii) oil and grease content of 70 mg/L.

<sup>1</sup> Note: These concentrations assume a design peak daily flow of 340 L per person per day.

**Underdrain media** - (as used in a sand filter) material that is placed under the *sand filter media* in a sand filter and is of a size to support the sand.

**Underdrain piping** - piping placed under the *sand filter surface area* in the *underdrain media* or *drain media* to collect the *effluent* that has travelled through the sand filter.

**Vadose zone** - the depth of *soil* from the top of the ground surface, in which *soil* water has a pressure head less than atmospheric pressure and is retained by a combination of adhesion and capillary action, to the depth at which *soil* water is at atmospheric pressure.

**Vertical separation** - the depth of unsaturated *soil* between the *soil infiltration surface* and a restricting condition. (See Appendix B-1.1.5.2., Vertical Separation.)

**Wastewater** - the composite of liquid and water-carried wastes associated with the use of water for drinking, cooking, cleaning, washing, hygiene, sanitation, or other domestic purposes; includes *greywater* but does not include liquid waste from industrial processes.

**Water course** -

- a) a river, stream, creek, or lake;
- b) swamp, marsh, or other natural body of water;



- c) a canal, reservoir, or other man-made surface feature intended to contain water for a specified use, whether it contains or conveys water continuously or intermittently, but does not include surface water run-off drainage ditches, such as those found at the side of roads; or
- d) an area that water flows through or stands in long enough to establish a definable change in or absence of vegetation (See definition of *shore*).

(See Appendix B-1.1.5.2., Water Course.)

**Water re-use** - a beneficial use of the treated *wastewater* directed to a specific purpose other than the general release to surface or subsurface environments.

**Water source** - a man-made or natural source of potable water.<sup>1</sup>

<sup>1</sup> *Note: A cistern is also considered to be a water source when buried in the earth. An above ground tank or a freestanding tank within a basement of a building would not have to meet minimum distance requirements from treatment components.*

**Water table** - the highest elevation in the *soil* at any given point in time where all voids are filled with water, as evidenced by the presence of water, *soil mottling*, or other *soil* characteristics that indicate intermittent saturated *soil* conditions.

**Water well** - an opening in the ground, whether drilled, bored, dug or otherwise altered from its natural state, which is used, or intended to be used, for the withdrawal of groundwater. (See Appendix B-1.1.5.2., Water Well.)

**Weeping lateral pipe** - the perforated pipe used to distribute *effluent* by gravity within a treatment field trench.

**Weeping lateral trench** - a trench in a *treatment field* that receives *effluent* and provides a *soil infiltration* surface.

**Working capacity** - the volume of *wastewater* composite held in the inlet chamber of the *septic tank* when the tank is properly installed and is in normal use, and does not include the air space, siphon chamber, pumping/dose chamber, or *effluent chamber* of a tank. (See Appendix B-1.1.5.2., Working Capacity.)

**1.1.6. Abbreviations**

**1.1.6.1. General**

1) Abbreviations in this Standard have the following meanings:

ABS	acrylonitrile-butadiene-Styrene	m <sup>2</sup>	square metre(s)
BOD <sub>5</sub>	<i>biochemical oxygen demand</i>	m <sup>3</sup>	cubic metre(s)
BNQ	Bureau de normalisation du Quebec	min	minute(s)
		mg/L	milligrams per litre
cBOD <sub>5</sub>	Carbonaceous Biochemical Oxygen Demand	mm	millimetre(s)
		NBC-AE	National Building Code – Alberta Edition
CFU	colony-forming units	No.	number(s)
cm <sup>2</sup>	square centimetre(s)	NH <sub>4</sub>	Ammonium
°	degree(s)	NO <sub>3</sub>	Nitrate
°C	degree(s) Celsius	NDWRCDP	National Decentralized Water Resources Capacity Development Project
CSA	Canadian Standards Association		
dia.	<i>diameter</i>	NSF	National Sanitation Foundation
DWV	drain, waste, and vent	NPS	nominal pipe size
EC	electrical conductivity	P	phosphorus
ft.	foot (feet)	PE	polyethylene
gpm	gallons per minute	PO <sub>4</sub>	ortho phosphate
gal.	gallons	PVC	poly (vinyl chloride)
Imp.	Imperial (gallons)	psi	pounds per sq. inch (pressure)
in.	inch(es)	SAR	sodium adsorption ratio
kPa	kilopascal(s)	sq.	square
L	litre(s)	temp.	temperature
L/min	litres per minute	TKN	total kjeldahl nitrogen
mL	millilitre	TOC	total organic carbon
kg	kilogram(s)	TSS	total suspended solids
lb	pound(s)	US	United States
m	metre(s)		(liquid gallon measure)
mm	millimetre(s)		
µm	micrometre(s) or microns		

## Part 2 General Requirements

### Section 2.1. General System Requirements

#### 2.1.1. General System Requirements — Objectives and Design Requirements

##### 2.1.1.1. General

- 1) An *on-site wastewater treatment system* designed and installed to meet the objectives and requirements of this Standard shall
  - a) be capable of treating the volume and strength of *wastewater* generated by the *development* served,
  - b) be suitable for the location and *soil* conditions at the site,
  - c) achieve the performance objectives required by this Standard and anticipated for the design,
  - d) accommodate maintenance and/or operational functions required by the system, and
  - e) be installed as per the design parameters approved by the *authority having jurisdiction*.

##### 2.1.1.2. Objectives and Design Requirements Based on Peak Flow

- 1) Subsection 2.2.2. shall be referenced to determine the applicability of objectives or requirements based on flow volumes and class of treatment system.<sup>1</sup>

<sup>1</sup> Note: Sentence (1) – See Appendix B-2.1.1.2.(1)

##### 2.1.1.3. Objectives Achieved Within Treatment Boundary Limits

- 1) *Wastewater* quality treatment objectives set out in this Standard shall be achieved before the *wastewater* meets the intended *treatment boundary limits* applicable to the design and required by site conditions whether the *wastewater* is on the surface where intended by the design, or moving through the *soil* and subsoil.
- 2) A treatment boundary limit set for all systems, except for lagoons and open discharge systems, is established at the surface of the ground and to a depth of 75 mm (3 in.) below ground surface in which the following limits will not be exceeded:<sup>1</sup>
  - a) fecal coliform < 10 cfu/100 mL above background levels, or
  - b) fecal coliform < 2 MPN/gram of dry *soil* above background levels.

<sup>1</sup> Note: Sentence (2) – See Appendix B-2.1.1.3.(2)

##### 2.1.1.4. Design Considerations

- 1) An *on-site wastewater treatment system* design shall consider<sup>1</sup>
  - a) the *soil* conditions determined by a complete site evaluation as required in Part 7;
  - b) the projected volume of *wastewater*, flow variation, and *wastewater* strength determined by an evaluation
    - i) as required in Section 2.2. of this Standard, and
    - ii) that considers any pertinent characteristics of the *development* not specifically set out in this Standard;
  - c) the impact of potential *groundwater mounding* resulting from the addition of the *effluent*;<sup>2</sup>
  - d) separation distances required by this Standard;

- e) cold-weather operation and other climatic conditions recorded by Environment Canada or another recognized source for the specific location where the *system* is installed;<sup>3</sup> and
- f) other objectives and prescriptive requirements of this Standard that may impact system design and performance.

<sup>1</sup> Note: Sentence (1) — The design may need to include consideration of cumulative impacts or loading limits established under other legislation. Also see Article 1.1.2.1.sentence (6)

<sup>2</sup> Note: Clause (1)(c) — For further explanation Articles 8.1.1.7. and 8.1.1.9.

<sup>3</sup> Note: Clause (1)(e) - Appendix A provides climatic data for various locations in Alberta and may be used to satisfy design criteria.

#### **2.1.1.5. Dosing of Effluent Required**

- 1) An *on-site wastewater treatment system* that includes a *soil infiltration surface* shall be capable of delivering *effluent* to the *soil infiltration surface* in a volume dose adequate to achieve effective distribution of the *effluent* and minimize the risk of system freezing.<sup>1</sup>

<sup>1</sup> Intent: Sentence (1) — The system should discharge effluent intermittently with sufficient volume to encourage distribution of effluent throughout the system and to reduce the incidence of freezing problems common with “Trickle Type” systems. Trickle type systems are not allowed by the Standard. A dose tank must be included in the system. The dose tank does not have to be integral to the septic tank. A separate tank is often better as it allows the designer to select a tank that has adequate volume to accomplish the desired dosing pattern.

#### **2.1.1.6. Effluent Filters**

- 1) All systems shall include an *effluent* filter that removes particles 3.2 mm (1/8 in.) in *diameter* and larger from the *effluent* being discharged to the *soil-based effluent* treatment component.
- 2) *Effluent* filters shall be selected to accommodate the flow rate through the filter required by the system design over the period of time intended for system service intervals set out in the operations manual developed for the system.<sup>1, 2</sup>

<sup>1</sup> Note: Sentence (2) — The filter should be selected to provide an intended service interval appropriate for the system while considering other required service intervals for the system. It should be inspected yearly and serviced as required. To provide clarity this requirement applies to both pressure distribution lateral systems and to gravity systems that rely on the infiltration of effluent into the soil. As such it includes an open discharge system that relies on infiltration into the soil.

<sup>2</sup> Note: Sentence (2) - See Appendix B-2.1.1.6.(2)

#### **2.1.1.7. Groundwater Infiltration**

- 1) An *on-site wastewater treatment system* shall be designed and installed to prevent the *infiltration* of groundwater into any component of the *system*.<sup>1</sup>

<sup>1</sup> Note: Sentence (1) - See Appendix B-2.1.1.7.

#### **2.1.1.8. Surface Storm Water Run-off**

- 1) The design and location of the *on-site wastewater treatment system* and finished landscaping shall minimize the impact of surface *storm water* run-off water on the performance and operation of the *system*.

**2.1.1.9. Service Access**

- 1) Components of an *on-site wastewater treatment system* that require regular maintenance shall be readily accessible such that servicing or required maintenance can be performed from the ground surface.
- 2) The location of tanks that need servicing by vacuum trucks shall be located such that reasonable access can be provided to the tank, considering distance and vacuum lift limitations.

**2.1.1.10. High-Strength Wastewater Considerations**

- 1) If the *development* served by the *on-site wastewater treatment system* is expected to generate *wastewater* that includes constituents normally not found in *typical wastewater*, or if the concentrations exceed the values anticipated in *typical wastewater*, the system design shall<sup>1</sup>
  - a) include specific features that effectively treat the *wastewater*, or
  - b) have the *wastewater* directed to a *holding tank* for treatment at an appropriate facility.

<sup>1</sup> Note: Sentence (1) — If the *wastewater source* only includes an increased organic load, it may be treated by an *on-site treatment system* with appropriate design considerations; however, in some cases the *wastewater* may include hydrocarbons, metals, or other chemicals that require specialized treatment offsite.

**2.1.1.11. Bypassing Treatment Phase Prohibited**

- 1) *Wastewater* shall not bypass any treatment phase of the *on-site wastewater treatment system*.<sup>1</sup>

<sup>1</sup> Intent: Sentence (1) — To ensure system effectiveness is not reduced due to ineffective flow management or treatment resulting from *wastewater* bypassing a component of the treatment system.

**2.1.2. General System Requirements — Prescriptive Requirements and Installation Standards****2.1.2.1. Site Suitability and Use of Holding Tanks**

- 1) An *on-site wastewater treatment system* shall not be installed where there is
  - a) insufficient area to meet all minimum distance requirements of this Standard for the intended system, or
  - b) no available location that has the *soil* and site characteristics, as determined by an evaluation required by Part 7 and set out in Part 8, required to develop a sustainable *on-site wastewater treatment system* that can accept and treat the *wastewater* load generated by the *development*.
- 2) Notwithstanding Clause (1)(b) and subject to Sentence (3), a *holding tank system* may be installed.
- 3) The suitability of using a *holding tank system* for a *development*, or a requirement that only a holding tank system be used, is subject to determination by the local municipal government, and if a *holding tank system* is used it shall conform with this Standard.<sup>1,2</sup>

<sup>1</sup> Intent: Sentence (3) — *holding tanks* are not a self-sustaining method of private *wastewater management*. The system relies on the availability of an approved offsite *wastewater treatment facility* creating a load on municipal infrastructure. Owners of *holding tanks* also incur ongoing costs for the removal and hauling of *wastewater* to approved treatment facilities. Municipalities have discretion regarding the acceptance of *holding tanks* as the *wastewater management solution* for a *development*.

<sup>2</sup> Note: Sentence (3) - See Appendix B – 1.1.5.2. Complex *on-site wastewater treatment systems*, for references to considerations to system designs that are out of scope of the SOP.

**2.1.2.2. Owner’s Responsibility**

- 1) The owner of an *on-site wastewater treatment system* shall ensure that the system
  - a) is maintained,
  - b) is operated within the design parameters of the *system*, and
  - c) effectively treats the *wastewater*.

**2.1.2.3. Designer and Installer Responsibility**

- 1) The *system* designer and *system* installer are responsible for ensuring that
  - a) the site has been sufficiently investigated and the design has considered and addressed all pertinent factors to achieve a functional *system*, and
  - b) testing and commissioning of the *system* is undertaken to confirm that it operates safely, as intended by the design and meets the objectives of this Standard.

**2.1.2.4. Separation from Specific Surface Waters**

- 1) The *soil*-based treatment component of an *on-site wastewater treatment system* shall be located not less than 90 m (300 ft.) from the *shore* of a<sup>1</sup>
  - a) lake,
  - b) river,
  - c) stream, or
  - d) creek.

<sup>1</sup> *Intent: Sentence (1) — The terms lake, river, stream, or creek are used specifically to separate them from other types of water courses to which this article does not apply. The purpose is to cause the location of the soil-based treatment component to be far enough from the body of water that upon a failure of surfacing effluent the effluent will not quickly and directly flow into the body of water. Alternatively, as set out in Sentence (2), the soil-based treatment component can be positioned on the lot, away from the body of water and in a location that will make a failure more easily noticed and upon failure will create an immediate inconvenience for the owner. This should result in a faster repair of the system. A watertight septic tank or similar watertight initial treatment component does not need to meet the requirements of this Article.*

- 2) Notwithstanding the requirements of Sentence (1), where a principal *building* (residence) or *farm building* (as defined) or other *development* feature<sup>1</sup> is situated between the *soil*-based treatment component and a specific surface water, such that a failure of the system causing *effluent* on the ground surface will be obvious and create an undesirable impact on the owner. The separation distance to the specific surface water may be reduced to the minimum distance requirements set out in this Standard for the particular type of treatment system being used. Subsequently for the purpose of Article 2.1.2.4., the separation distance to a *farm building* shall be the same as the distance prescribed to a *building* as set out in this Standard for the particular type of treatment system being used.

<sup>1</sup> *Note: Sentence (2) – under the authority having jurisdiction.*

**2.1.2.5. Prohibited Discharge Locations**

- 1) *Wastewater* or *effluent* shall not be discharged
  - a) into a well, abandoned well, aquifer, or water supply;
  - b) into any surface body of water such as, but not limited to, a lake, river creek, stream, natural wetland, or constructed aqua-scape/water feature;
  - c) onto any vegetable garden; or
  - d) into any other system or location not consistent with the designs provided under this Standard.

### 2.1.2.6. Prohibited Wastes and Substances

- 1) On-site *wastewater* treatment systems designed under the prescriptive requirements of this Standard shall not receive substances and *wastewater* that could adversely affect the operation of the *system*, which include, but are not limited to, the following:<sup>1</sup>
  - a) *storm water*;
  - b) *surface water*;
  - c) *abattoir waste*;
  - d) *sub-surface seepage water* from weeping tile systems, foundation drains, or subsoil foundation drainage pipes;
  - e) *clearwater waste* from a hot tub, spa, or hydro massage bath that is not of the fill-and-drain design, unless the design of the system specifically includes capacity for the additional *wastewater* flow and instantaneous flow conditions the fixture will cause along with the potential disinfectants in the water;
  - f) *clearwater waste* from a swimming pool, except that the waste from the area drains around the pool area may discharge into a system;
  - g) *commercial or industrial process wastes*;
  - h) *waste from a water filter or other water treatment device*, if the *on-site wastewater treatment system* has not been designed to receive and treat the discharge from the filter or treatment device;<sup>2,3,4</sup>
  - i) *wastes from an iron filter*; and
  - j) *other wastes not considered in the design of the system*.

<sup>1</sup> *Intent: Sentence (1) — The wastewater treatment systems identified in this Standard are intended for treating wastewater. Substances, contaminants, and wastewater constituents not typically expected in domestic wastewater require special consideration.*

<sup>2</sup> *Warning: Clause (1)(h) — The use of water softeners and the discharge of regeneration wastes are not specifically prohibited from discharging to an on-site wastewater treatment system. The use of sodium salts in a water softener is generally more harmful to the soil-based treatment component of a treatment system than the use of potassium based salts. Increased sodium levels will be present in the domestic water used daily in the house, and may be further increased by the inefficient backwash functioning of a water softener that does not control the regeneration by flow volume. High levels of sodium can reduce the effectiveness of the on-site wastewater treatment system and reduce its life expectancy, particularly when it is located in fine-textured clay soils. Sodium occurring naturally in the groundwater or introduced to the water supply by a water softener using sodium salts may affect the ability of the soil to absorb the effluent. High sodium adsorption ratio effluent and the presence of expansive clays, such as montmorillonite clay (Refer to Appendix A.3.B. and Appendix A.3.C. for mapping of montmorillonite clays) in the soil may cause a soil-based treatment component to fail. Additional considerations from those set out in this Standard may be required. (See Appendix B-2.1.2.6.(1)(h)2)*

<sup>3</sup> *Note: Clause (1)(h) — The use of potassium salts as a regeneration agent in a water softener is not expected to have the same negative effect on expansive clays as the use of sodium salts.*

<sup>4</sup> *Warning: Clause (1)(h) — The discharge of waste from water treatment devices can generate large volumes of water that are not included in flow estimates set out in this Standard. They may generate volumes that cannot be accurately predicted or include substances that are difficult to treat or can harm the system and cause a failure.*

### 2.1.2.7. Construction Wastes Removed Prior to Commissioning a System

- 1) The installer of a *system* shall ensure that during construction of the *development*, substances that may harm or reduce the effectiveness of the system do not enter the system or are removed before the system is put into operation.

**2.1.2.8. Owner's Manual**

- 1) Prior to putting an *on-site wastewater treatment system* into operation, an operations and maintenance manual shall be made available to the owner detailing
  - a) the capacity of system design;
  - b) the principles of operation;
  - c) the construction details, including a site plan showing the specific as-built location and area occupied by treatment components;
  - d) pump capacity requirements, control settings, float elevations, and dosing volumes as applicable;
  - e) all operating and maintenance requirements; and
  - f) instructions on managing an alarm condition.
  
- 2) An operations and maintenance manual shall be affixed in close proximity to the electrical service panel or another clearly visible, accessible location of the *development*.

**2.1.3. General System Requirements — Requirements for Materials**

**2.1.3.1. General**

- 1) All materials, systems, and equipment used in an *on-site wastewater treatment system* shall be designed for and possess the necessary characteristics to perform their intended functions.



## Section 2.2. Wastewater Flow and Strength

### 2.2.1. Wastewater Flow and Strength — Objectives and Design Requirements

#### 2.2.1.1. General

- 1) The *on-site wastewater treatment system* shall achieve treatment of the *wastewater* within the range of volume and strength of *wastewater* generated by the *development*.<sup>1</sup>

<sup>1</sup> Note: Sentence (1) – See Appendix B-2.2.1.1.(1)

#### 2.2.1.2. Wastewater Strength Projected in Design

- 1) A system design shall include a projection of *wastewater* strength.

#### 2.2.1.3. Methods of Projecting Wastewater Strength

- 1) The mass or concentration of constituents of concern in the *wastewater* shall be estimated using
  - a) values set out in this Standard,
  - b) published guidelines acceptable to the *Administrator*,
  - c) analytical results of *wastewater* samples taken following appropriate sampling and analytical protocols, or
  - d) *wastewater* quality data collected from similar establishments.

#### 2.2.1.4. Peak Wastewater Flow for Design

- 1) The *system* design flow shall be based on the daily peak flow expected from the *development*.<sup>1</sup>

<sup>1</sup> Note: Sentence (1) – See Appendix B-2.2.1.4.(1)

- 2) The daily peak flow referred to in Sentence (1) shall be estimated using<sup>1</sup>
  - a) the prescriptive requirements of this Standard,
  - b) metered flow to establish a daily peak flow design value based on applying
    - i) a safety factor of 1.5 to the mean metered flow in order to provide the required safety in design, or
    - ii) a larger factor to accommodate any potential increases in flow anticipated due to changes in use of the *development* over time and uncertainties in the metered flow data;
  - c) data collected from similar developments if an appropriate safety factor is included to accommodate peak flow; or
  - d) published guidelines or standards acceptable to the *Administrator*.

<sup>1</sup> Note: Sentence (2) - See Appendix B-2.2.1.4.(2)

- 3) The meter referred to in Clause (2)(b) must be recorded daily for at least 30 consecutive days during a typical peak flow period or as otherwise acceptable to the *Administrator*.
- 4) If the daily water use of a *development* is expected to vary substantially between days of the week and a flow equalization and management method that effectively distributes the flow to the treatment components over a 7-day period is used, the system design may be based on the averaged 7-day peak flow calculated using the expected use frequency of the *development*.<sup>1</sup>

<sup>1</sup> Note: Sentence (4) — Examples of a development that can expect to see variations include churches, community halls, schools, and office buildings. Flow equalization and management can increase the effectiveness of the treatment system and reduce costs.

### 2.2.1.5. Consideration of High Flow Fixtures

- 1) The system design shall include a method for managing additional volume and high instantaneous flow rates, or have the capacity to treat the *wastewater* at the high flow rate, where the *development* includes fixtures that<sup>1</sup>
  - a) will generate high instantaneous flows, or
  - b) are likely to increase flow volumes above levels normally expected of that type of *development*.

<sup>1</sup> Note: Sentence (1) – See Appendix B-2.2.1.5.(1)

### 2.2.1.6. Consideration of Water Conservation Fixtures

- 1) Where the *development* includes low-flow or water conservation fixtures that will generate lower flow volumes, the system shall be designed to treat the increased *wastewater* strength that will result.<sup>1</sup>

<sup>1</sup> Note: Sentence (1) – See Appendix B- 2.2.1.6.(1)

### 2.2.1.7. Highly Variable Flow Volumes During the Day

- 1) A system serving a *development*, such as, but not limited to, a motel or other facility that will generate the majority of daily flow during a short period of the day or is subject to high instantaneous flow, shall include flow equalization to attenuate the high-flow periods.<sup>1</sup>

<sup>1</sup> Note: Sentence (1) – See Appendix B-2.2.1.7.(1)

## 2.2.2. Wastewater Flow and Strength — Prescriptive Requirements and Installation Standards

### 2.2.2.1. Influent Wastewater Quality

- 1) Unless otherwise specified, the requirements of this Standard anticipate an influent raw *wastewater* strength that<sup>1</sup>
  - a) 80% of the time does not exceed
    - i) BOD<sub>5</sub> of 220 mg/L,
    - ii) TSS of 220 mg/L, and
    - iii) oil and grease content of 50 mg/L, and
  - b) does not exceed maximum values of
    - i) BOD<sub>5</sub> of 300 mg/L,
    - ii) TSS of 350 mg/L, and
    - iii) oil and grease content of 70 mg/L.

<sup>1</sup> Note: Sentence (1) — At daily flow volumes assumed in this Standard.

- 2) If the *wastewater* strength is projected to exceed the values set out in Sentence (1), the system shall<sup>1</sup>
- a) include additional treatment capacity to achieve the *effluent* quality required for the downstream component,
  - b) have the downstream component include additional treatment capacity appropriate for the higher *wastewater* strength, or
  - c) have a combination of the requirements referred to in Clauses (a) and (b).

<sup>1</sup> Note: Sentence (2) – See Appendix B-2.2.2.1.

- 3) If the *development* is non-residential, the projection of *wastewater* strength shall not be less than the highest strength determined by<sup>1</sup>
- a) the values estimated in Table 2.2.2.1. for the type of *development* listed,
  - b) *wastewater* strength projections set out in published information acceptable to the *Administrator* that is more specific to the *development*, or
  - c) the measured *wastewater* strength from similar developments.

<sup>1</sup> Note: Sentence (3) – See Appendix B-2.2.2.1.(3)

Table 2.2.2.1. Non-Residential Projected Wastewater Strength	
<p><i>Note: These values are minimums. The designer must determine and substantiate the correct wastewater strength to use in the design for the particular application. Actual values are often substantially higher than the values set out below.</i></p>	
Non-Residential development	Minimum Projected Wastewater Strength, mg/L
Restaurant	600 BOD <sub>5</sub> ; 400 TSS; 200 Oil & Grease
Work camp	600 BOD <sub>5</sub> ; 400 TSS; 200 Oil & Grease
Campground with RV dump station	600 BOD <sub>5</sub> ; 400 TSS; 70 Oil & Grease

- 4) All systems, except a *lagoon*, shall include an *effluent* testing port or a readily accessible location that enables sampling of the *effluent* at a point downstream of any manufactured *effluent* treatment component and prior to discharge to the *soil*-based treatment component.<sup>1</sup>

<sup>1</sup> Note: Sentence (4) – Sampling from the *effluent* chamber may be acceptable if there is no filter required downstream of the pump.

- 5) For a *system* where the anticipated *wastewater* strength exceeds that of *typical wastewater*, the *effluent* discharged to the *soil infiltration surface* area shall be tested once the system is commissioned to confirm that the design has achieved the *effluent* quality intended by the initial treatment components.<sup>1</sup>

<sup>1</sup> Note: Sentence (5) – See Appendix B-2.2.2.1.(5)

**2.2.2.2. Peak Daily Wastewater Volume**

- 1) The expected peak daily volume of *wastewater* used for system design shall not be less than the values provided in<sup>1</sup>
  - a) Table 2.2.2.2.A. for residential developments,<sup>2</sup>
    - i) when a basement is undeveloped, consideration must be made to the design for future use.
  - b) Table 2.2.2.2.B. for non-residential developments, or
  - c) accordance with Article 2.2.1.4.

<sup>1</sup> *Intent: Sentence (1) — The expected volumes of wastewater listed in Tables 2.2.2.2.A. and 2.2.2.2.B. are for uses typically expected in the corresponding type of occupancy. With regard to residential applications, additional fixtures, high capacity fixtures, or home designs that support entertaining events are expected to increase the load substantially. The designer and or installer must consider additional load factors when determining the expected sewage per day. The expected volume of sewage set out in these tables includes a volume that allows for a reasonable number of operational personnel.*

<sup>2</sup> *Note: Clause (1)(a) - See Appendix B-2.2.2.2.(1)(a)*

<b>Table 2.2.2.2.A. Residential Peak and Mean Volumes of Wastewater Per Day</b>			
Facility	Peak expected daily wastewater volume	Additional capacity required based on plumbing F.U. total	Mean daily wastewater volume
Single-family dwelling and duplex	<ul style="list-style-type: none"> <li>• 2 bedrooms or less: 2 people per bedroom X 340L (75 Imp.gal.) per person</li> <li>• 3 bedrooms or more: 1.5 persons per bedroom X 340L (75 Imp.gal.) per person</li> </ul>	Add 50 L (11 Imp. gal.) for each fixture unit exceeding: <ul style="list-style-type: none"> <li>- 25 in a 2- or 3-bedroom res. /occupancy unit</li> <li>- 28 in a 4-bedroom res. /occupancy unit</li> <li>- 31 in a 5-bedroom res./occupancy unit</li> <li>- 34 in a 6-bedroom res./occupancy unit</li> <li>- the sum of 34 + 3 F.U. / each bedroom over 6 bedrooms to determine F.U. load when there are more than 6 bedrooms</li> </ul>	228L (50 Imp. Gal.) per person
Residential Occupancy other than single family dwelling or duplex	<ul style="list-style-type: none"> <li>• 340 L (75 Imp. gal.) X 2 persons per bedroom</li> </ul>	When the combined total of fixture units exceeds 20 in an occupancy unit, add 50 L for fixture unit over 20.	228L (50 Imp. G al.) per person

<sup>1</sup> *Note: Table 2.2.2.2.A. — Fixture units are a value assigned to plumbing fixtures related to their frequency of use, rate of discharge, and anticipated volume. The following table lists fixture unit values for common fixtures. For a complete fixture unit loading list, refer to the National Plumbing Code.*

Fixture	FU value	Fixture	FU value
Basin	1	Kitchen sink	1.5
Bathtub	1.5	Laundry stand pipe	2
Single head shower 2 or 3 heads	1.5 3	Laundry tray (1 or 2 compartment)	1.5
Water Closet (toilet) flush tank	4	Floor drain 4 inch 3 inch 2 inch	3 3 2
Bathroom group	6	Bidet	1

*\*A bathroom group (the combined load from a tub/shower, toilet and basin) is rated at 6 fixture units.*

*A floor drain does not need to be counted in the fixture unit load from a building unless it receives waste from a fixture or water-using device.*

Facility	Peak daily wastewater volume in litres (Imp. gallons) per day
Assembly Hall	32 (7) per seat
Campground (full service)	80 (18) per campsite
Church without kitchen	23 (5) per seat
Church with kitchen	32 (7) per seat
Construction Camp	225 (50) per person
Day Care Centre	113 (25) per child
Golf Club	45 (10) per member
Golf Club with bar and restaurant add	113 (25) per seat
Hospital (no resident personnel)	900 (198) per bed
Industrial and Commercial Building (does not include process water, showers or a cafeteria)	45 (10) per employee
Industrial and Commercial Building (with showers)	90 (18) per employee
Institution (residential)	450 (99) per resident
Laundry (coin operated)	1800 (396) per machine
Liquor License Establishment	113 (25) per seat
Mobile Home Park	1350 (297) per space
Motel/Hotel	90 (20) per single bed
Nursing and Rest Homes	450 (99) per resident
Office Building	90 (20) per employee
Recreational Vehicle Park (special considerations are required for systems receiving waste from RV's as it may contain formaldehyde that could cause the <i>system</i> to fail)	180 (40) per space
Restaurant (24-hour)	225 (50) per seat
Restaurant (not 24-hour)	160 (35) per seat
School: Elementary	70 (15) per student
Junior High	70 (15) per student
High School	90 (20) per student
Boarding	290 (64) per student
Service Station (not including café or restaurant)	560 (123) per fuel outlet
Swimming Pool (public) based on design bathing load	23 (5) per person

### 2.2.2.3. Additional or High Capacity Fixtures

- 1) Where additional fixtures or high capacity fixtures are installed, the system shall have the capacity to manage the additional load, determined in accordance with Table 2.2.2.3. or by the application of Articles 2.2.1.4. and 2.2.1.5.<sup>1,2</sup>

<sup>1</sup> Intent: Sentence (1) — This table provides a minimum estimate of the additional volume needed to accommodate both increased overall peak flow and instantaneous loading generated by the fixture.

<sup>2</sup> Note: Sentence (1) – See Appendix B-2.2.2.3.(1)

Fixture	Add to expected peak daily wastewater volume in litres (Imp. gallons) per day
Hydro-massage and soaker tubs (fill and drain style)	[Volume of tub in litres (minus 340 liters) x 2] [Volume of tub in Imp. gallons (minus 75 gal.) x 2]
The design Peak Flow needs to increase to adequately handle the instantaneous flow from these fixtures. Flow equalization should be included in the <i>system</i> if these types of fixtures are present in the <i>development</i> as required by Article 2.2.1.5	
Water Softener Discharge	15% increase in peak daily wastewater volume
Other High Capacity Fixture	A volume reasonably anticipated from the specific fixture shall be added to peak daily wastewater volume and will consider the impact on peak instantaneous flow.
High Flow Volume Showers (discharging in excess of 13 L (3 Imp. gal.) per minute)	Add 50 L (11 gallons) for every 6 L (1.5 gallons) per minute or portion thereof that exceeds a 13 L (3 Imp. gal.) per minute discharge (normal shower discharge)

### 2.2.2.4. Flow Estimates with Water-Saving Fixtures

- 1) Where a design is based on the prescriptive requirements of this Standard, the peak daily flow estimates shall not be reduced from the values set out in Subsection 2.2.2. when water saving fixtures or devices are used, unless adequate consideration of the increased *wastewater* strength is made.<sup>1</sup>

<sup>1</sup> Note: Sentence (1) — Reduced water usage resulting from the use of water conservation measures or fixtures will increase wastewater strength a corresponding amount so no reduction in soil infiltration surface area should be applied.

**2.2.2.5. Flow Equalization**

- 1) In systems that require flow equalization<sup>1</sup>
  - a) the capacity of the tank providing flow equalization shall be not less than the peak daily flow or 1.5 times the average daily flow volume, and
  - b) a pump control system shall be provided that will spread small doses of the daily *wastewater* volume over a 24-hour period.

<sup>1</sup> Note: Sentence (1) – See Appendix B-2.2.2.5.(1)

**2.2.2.6. Garbage Grinders**

- 1) Where a garbage grinder is installed in a residential *development*, there shall be a
  - a) 5-percent increase to the expected peak daily *wastewater* volume projection,
  - b) 30-percent increase to the *wastewater* strength projection, and
  - c) 50-percent increase in the projected volume of sludge storage required in a *septic tank*.
- 2) In all other developments, the specific increase in loading due to the garbage grinder shall be calculated in the design.



## Section 2.3. System Controls: System Flow Less than 5.7 Cubic Metres per Day

### 2.3.1. System Controls: System Flow Less than 5.7 Cubic Metres per Day — Objectives and Design Requirements

#### 2.3.1.1. Application

- 1) Subsection 2.3.1. applies to all *on-site wastewater treatment systems* where the estimated peak *wastewater* flow from the *development* is less than 5.7 m<sup>3</sup> (1,250 Imp. gal.) per day.

#### 2.3.1.2. Alarms Required

- 1) All *on-site wastewater treatment systems*, including *holding tank* systems but excluding *lagoons* and *privies*, shall include a mechanism or process capable of visually and audibly warning the user of the system when high liquid level conditions above the normal operating specifications exist.
- 2) A control system for a timed dosing system shall include an alarm that visually and audibly indicates to the user that the *wastewater* flow is exceeding the design settings of the system.<sup>1</sup>
- 3) The visual and auditory alarm signals shall continue to function in the event of an electrical, mechanical, or hydraulic malfunction of the system.<sup>2</sup>

<sup>1</sup> Note: Sentence (2) – See Appendix B-2.3.1.2.(2)

<sup>2</sup> Note: Sentence (3) – See Appendix B2.3.1.2.(3)

#### 2.3.1.3. Control Systems Required

- 1) All treatment systems shall include the necessary system controls to achieve the level of functionality, operation, and monitoring of the system required to meet the objectives and requirements of this Standard.<sup>1</sup>

<sup>1</sup> Intent: Sentence (1) — Depending on the system design and treatment demands of the site, various control systems will be required. For example, if a sand filter design requires small volume time spaced dosing of effluent to achieve the expected level of treatment, the control required to achieve that must be provided.

#### 2.3.1.4. Mounting of Water Level Control Devices

- 1) Water level control devices shall be mounted in a manner that allows for the<sup>1</sup>
  - a) removal or adjustment of the devices without requiring the disconnection of other system components, and
  - b) re-installation of devices at a consistent reference elevation.

<sup>1</sup> Note: Sentence (1) — To achieve this, water level control floats are mounted on a float mast that is independent of other piping and components. This enables the removal and replacement of the water control floats or other system components in a manner that ensures float settings remain at the level intended for the design. Mounting or securing these water level control devices to the effluent piping does not achieve the intent of this Article. (See Appendix B-2.3.1.4.(1)1)

#### 2.3.1.5. Detection and Data Recording for Secondary Treatment Systems

- 1) Treatment systems where a secondary treatment level is achieved prior to distribution of the *effluent* to a final *soil*-based treatment must include a component capable of<sup>1</sup>
  - a) detecting electrical or mechanical failures that are critical to the treatment process;
  - b) detecting high liquid level conditions above the normal operating specifications;
  - c) determining daily flow volumes; and
  - d) collecting and recording the operational data history as defined in Clauses (a), (b), and (c) for a minimum of the previous 30 days.

<sup>1</sup> Note: Sentence (1) – See Appendix B-2.3.1.5.(1)

- 2) The collection of operational data history shall cover a sufficient period to provide information that can be used to develop a report on the system’s operational performance that can be reviewed to
  - a) evaluate operational problems,
  - b) optimize system performance, and
  - c) evaluate the achievement of treatment objectives.

#### **2.3.2. System Controls: System Flow Less than 5.7 Cubic Metres per Day — Prescriptive Requirements and Installation Standards**

##### 2.3.2.1. Application

- 1) Subsection 2.3.2. applies to all *on-site wastewater treatment systems* where the estimated peak *wastewater* flow from the *development* is less than 5.7 m<sup>3</sup> (1,250 Imp. gal.) per day.

##### 2.3.2.2. Location of Alarm and Warning Devices

- 1) Alarm and warning devices shall be located where
  - a) the visual alarm signal is reasonably conspicuous to the user(s) of the system, and
  - b) the audible alarm location and signal strength are reasonably conspicuous to the user(s) of the system.

##### 2.3.2.3. Alarm Back-up

- 1) The alarm shall be connected to a separate electrical circuit that is not associated with the *wastewater* treatment system, or shall have a battery back-up that provides a minimum of 4 hours’ operation.<sup>1</sup>

##### 2.3.2.4. Silencing Alarm Caused by Malfunction

- 1) An alarm or warning device may include the ability to silence an audible alarm, provided the visual signal continues to function until the condition is corrected and the alarm includes an automatic re-setting feature.

##### 2.3.2.5. Pump Control Redundant Off

- 1) When control systems for the *on-site wastewater treatment system* include a pump “on-off-auto” switch, the control system shall be equipped with a redundant-off water level controller that prevents the pump from running in the event of inadvertent operation of the pump in the manual-on setting.

**2.3.2.6. Controls and Wiring Protected From Corrosive Environments**

- 1) System controls, alarm devices, and electrical connections shall not be located in any space that communicates directly with the *wastewater*, gases, or vapours generated from the *wastewater*, unless the system control or alarm device is specifically designed for installation in the corrosive and high-moisture environment.

**2.3.3. System Controls: System Flow Less than 5.7 Cubic Metres per Day — Requirements for Materials**

**2.3.3.1. Certification of System Controls and Alarm Devices**

- 1) System controls and alarm devices shall be specifically designed for the use in on-site *wastewater* treatment systems and *certified* to the applicable electrical equipment standards and comply with the Canadian Electrical Code Part 1 and provincial electrical regulations as amended or replaced from time to time.

## Section 2.4. System Controls and Monitoring: System Flow Greater than 5.7 Cubic Metres per Day

### 2.4.1. System Controls: System Flow Greater than 5.7 Cubic Metres per Day — Objectives and Design Requirements

#### 2.4.1.1. Application

- 1) Subsection 2.4.1. applies to all on-site *wastewater* treatment systems where the estimated peak *wastewater* flow from the *development* is greater than 5.7 m<sup>3</sup> (1,250 Imp. gal.) per day.

#### 2.4.1.2. General

- 1) All treatment systems must include the necessary system controls to achieve the level of functionality, operation, and monitoring of the systems required to meet the objectives and requirements set out in this Standard.<sup>1</sup>

<sup>1</sup> *Note: Sentence (1) — Objectives and requirements related to a specific type of system and/or site conditions will vary and may be established in other sections of this Standard.*

#### 2.4.1.3. High Liquid Level Warning

- 1) All treatment systems shall include a mechanism or process capable of visually and audibly warning the user of the system when liquid levels exceed the maximum design capacity.

#### 2.4.1.4. Holding Tank High Liquid Level Warning

- 1) All *holding tank* systems excluding *privies* must include a mechanism or process capable of visually and audibly warning the user of the *holding tank system* when liquid levels exceed the normal operating specifications.

#### 2.4.1.5. Alarm Back-Up

- 1) The visual and auditory alarm signals shall continue to function in the event of an electrical, mechanical, or hydraulic malfunction of the system.

#### 2.4.1.6. Detection and Data Recording

- 1) All treatment systems must include a component capable of
  - a) detecting electrical or mechanical failures that are critical to the treatment process;
  - b) detecting high liquid level conditions above the normal operating specifications;
  - c) determining daily flow volumes; and
  - d) collecting and recording an operational data history as defined in Clauses (a), (b), and (c) for a minimum of the previous 30 days.
- 2) The collection of operational data history shall cover a sufficient period to provide information that can be used to develop a report on the system's operational performance that can be reviewed to
  - a) evaluate operational problems,
  - b) optimize system performance, and
  - c) evaluate the achievement of treatment objectives.

**2.4.1.7. Mounting of Water Level Control Devices**

- 1) Water level indicating devices shall be mounted in a manner that allows for the<sup>1</sup>
  - a) removal or adjustment of the devices without requiring the disconnection of other system components, and
  - b) re-installation of devices at a consistent reference elevation.

<sup>1</sup> *Note: Sentence (1) — Water level control floats should be mounted on a float mast that is independent of other piping and components. This enables the removal and replacement of the water control floats or other system components in a manner that ensures float settings remain at the level intended for the design. Controls cannot be mounted on wastewater piping and accomplish the intent of this Article.*

**2.4.1.8. Managing Flow Variation**

- 1) The system design shall have features, including tanks and controls, that effectively manage daily or day-to-day flow variations to optimize system effectiveness and function.<sup>1</sup>

<sup>1</sup> *Intent: Sentence (1) — This would typically be accomplished with adequate tank volume and timed dosing controls.*

**2.4.1.9. Monitoring Wells**

- 1) The system design shall include *vertical separation* monitoring wells that extend to a depth below *grade* sufficient to confirm that the required *vertical separation* from the *soil infiltration surface* to saturated *soil* conditions is maintained during operation of the system; these monitoring wells shall be located within or immediately adjacent to the *soil-based treatment area*.<sup>1</sup>

<sup>1</sup> *Note: Sentence (1) — The purpose of the vertical separation well is to enable monitoring of soil water conditions within the soil depth below the infiltration surface of the wastewater system needed for effective treatment (the required vertical separation). These vertical separation wells are not used to measure depth to the water table. Vertical separation wells should not go to a depth that extends into a lower soil profile having a significantly higher hydraulic conductivity rate than the soil at the infiltration surface. If there are significant changes in the underlying profile, additional vertical separation wells should be provided, some to the depth of the required vertical separation and some to a lesser depth that can confirm overlying finer textured soils with a lower hydraulic conductivity have not become saturated creating a perched water table.*

- 2) An *on-site wastewater treatment system* serving a *development* expected to generate more than 5.7 m<sup>3</sup> (1,250 Imp. gal.) in peak daily *wastewater* flow shall include a minimum of 3 groundwater monitoring wells to a minimum depth of 15 m (50 ft.), at least one up gradient and two down gradient as measured by groundwater elevation, located to optimize the measurement of groundwater impact, if the system is located above GWUDI which meets the criteria of a domestic use aquifer.
- 3) An *on-site wastewater treatment system* serving a *development* that is expected to generate more than 9 m<sup>3</sup> (1,980 Imp. gal.) in peak daily *wastewater* flow shall include a minimum of 3 groundwater monitoring wells to a minimum depth of 15m (50 ft.), at least one up gradient and two down gradient as measured by groundwater elevation, located to optimize the measurement of groundwater impact where a system is located within 2 km (1.25 miles) of a
  - a) lake,
  - b) river,
  - c) creek, or
  - d) stream.

- 4) Notwithstanding the requirements of Sentence (2) and (3) that set out a minimum depth of 15m (50 ft.), in no case shall a monitoring well required by this Standard be developed into a confined aquifer.
- 5) The design shall include monitoring ports that can be used to monitor *effluent* ponding on the *soil infiltration* surface of a *soil*-based treatment system or on the surface of the treatment medium used in a system to improve *effluent* quality such as, but not limited to, a *treatment mound* or *sand filter*.
- 6) *Effluent* sampling ports or access shall be provided in locations as required by the design to confirm that treatment and operational objectives are achieved prior to application of the *wastewater effluent* to the *soil infiltration surface*.

**2.4.2. System Controls and Monitoring: System Flow Greater than 5.7 Cubic Metres per Day — Prescriptive Requirements and Installation Standards**

**2.4.2.1. Application**

- 1) Subsection 2.4.2. applies to all *on-site wastewater treatment systems* where the estimated peak *wastewater* flow from the *development* is greater than 5.7 m<sup>3</sup> (1,250 Imp. gal.) per day.

**2.4.2.2. Installation**

- 1) System controls and alarm devices shall be installed in compliance with the Canadian Electrical Code Part 1 and provincial electrical regulations.

**2.4.2.3. Protection from Harmful Vapours**

- 1) System controls, alarm devices, and electrical connections shall not be located in any space that communicates directly with the *wastewater*, gases, or vapours generated from the *wastewater*, unless the system control or alarm device is specifically designed for installation in the corrosive and high-moisture environment.

**2.4.2.4. Pump Control Redundant Off**

- 1) The *on-site wastewater treatment system* shall be equipped with a redundant-off water level controller for the pump that prevents the pump from running in the event of a failure of the main-off water level control or inadvertent operation of the pump in the manual-on setting.

**2.4.3. System Controls and Monitoring: System Flow Greater than 5.7 Cubic Metres per Day — Requirements for Materials**

**2.4.3.1. Certification of System Controls and Alarm Devices**

- 1) System controls and alarm devices shall be *certified* to the applicable electrical equipment standards and comply with the Canadian Electrical Code Part 1 and provincial electrical regulations.

## Section 2.5. Piping

### 2.5.1. Piping — Objectives and Design Standards

#### 2.5.1.1. Leaking

- 1) Piping shall not leak except where intended in the design.

#### 2.5.1.2. Freezing

- 1) The system design shall prevent the freezing of liquids in the piping.

#### 2.5.1.3. Grading and Sizing

- 1) Piping shall be sloped and sized to accommodate the designed flow of *wastewater* or *effluent* and the drainage of piping when required to prevent freezing.<sup>1</sup>

<sup>1</sup> *Intent: Sentence (1) — Gravity piping must maintain a slope required for the flow volume and drain completely. Pressure piping must maintain sufficient slope to drain when required to prevent freezing. pressure distribution piping shall be of sufficient size to deliver the required volume at the required pressure. Tables A.1.C.1., A.1.C.2., A.1.C.3., and A.1.C.4. in Appendix A may be used for sizing of pressure distribution piping, manifolds, and supply piping at the required pressure-head loss.*

#### 2.5.1.4. Supports

- 1) Piping shall be sufficiently supported to
  - a) prevent sagging,
  - b) withstand expected mechanical forces, and
  - c) withstand forces resulting from the movement of liquid in the system.

#### 2.5.1.5. Design Pressure Rating

- 1) Piping shall be approved for a pressure rating of at least 1.5 times the maximum pressure it may be subjected to by the system design.

### 2.5.2. Piping — Prescriptive Requirements and Installation Standards

#### 2.5.2.1. Sewer Line Support

- 1) *Effluent* sewers and *distribution header* piping shall be evenly and continuously supported.

#### 2.5.2.2. Distribution Header Support

- 1) A *distribution header* serving weeping lateral trenches at different elevations shall be evenly and continuously supported on a bed of undisturbed or tightly compacted earth between trenches to adequately support the piping and prevent migration of *effluent* to a lower lateral.<sup>1</sup>

<sup>1</sup> *Intent: Sentence (1) — To support the pipe and to prevent the migration of effluent through the ground from a weeping lateral trench at a higher elevation into another weeping lateral trench at a lower elevation.*

**2.5.2.3. Protection from Freezing**

- 1) A *building sewer* or *effluent sewer* having less than 1200 mm (4 ft.) of *soil* cover where it crosses under a ditch, driveway, or path shall be protected from freezing by a frost box, culvert, or other equivalent means.<sup>1</sup>

<sup>1</sup> *Note: Sentence (1) – See Appendix B-2.5.2.3.(1)*

**2.5.2.4. Sizing**

- 1) *Effluent sewer* piping shall not be smaller than 75 mm (3 in.) in pipe size.

**2.5.2.5. Slope of Sewer Piping**

- 1) A 100 mm (4 in.) *building sewer* or *effluent sewer* shall have a minimum slope of 1% (1/8 inch per foot).
- 2) A 75 mm (3 in.) *building sewer* or *effluent sewer* shall have a minimum slope of 2% (1/4 inch per foot).

**2.5.2.6. Backfill**

- 1) Backfill shall be carefully placed to prevent damage or dislocation of piping, and the backfill shall be free of stones, boulders, cinders, and frozen earth for a minimum depth of 150 mm (6 in.) above the piping.<sup>1</sup>

<sup>1</sup> *Intent: Sentence (1) – To prevent damage to the pipe during and after backfill.*

**2.5.2.7. Piping Connections to Tank**

- 1) Piping connections to any tank or vessel used in the treatment systems shall be water-tight, flexible connections that will prevent *infiltration* and exfiltration and continue to provide a water-tight connection in the event the tank or piping shifts.
- 2) Piping connected to any tank or vessel shall be supported to within 300 mm (1 ft.) of the tank outlet or inlet on undisturbed *soil* or other suitable support.<sup>1</sup>
- 3) Gravity drainage piping connected to a tank shall be *DWV pipe* or piping of equivalent structural strength for at least 1800 mm (6 ft.) from the tank.<sup>2</sup>

<sup>1</sup> *Intent: Sentence (2) – The inlet and outlet piping connected to a tank must be protected from distortion caused by settling of the backfill material. The excavation for a tank should not be any longer than is necessary to install the tank. This provides undisturbed earth closer to the tank to support the inlet and outlet piping connected to the tank. A pipe with a greater wall thickness provides an added safety factor.*

<sup>2</sup> *Intent: Sentence (3) – The inlet and outlet piping connected to a tank are subject to distortion caused by settling of the tank and the excavation around the tank. Heavy wall pipe, and close excavation to minimize the distance to undisturbed earth, provides an added element of safety that is needed.*



### 2.5.3. Piping — Requirements for Materials

#### 2.5.3.1. Piping in Pressure Applications

- 1) The piping used in a pressure application shall be *certified* to one of the following standards:<sup>1</sup>
  - a) for pressure *effluent line*:
    - i) CAN/CSA-B137.1, “Polyethylene Pipe, Tubing and Fittings for Cold Water Pressure Services,” (Series 160 with compression fittings or Series 75, 100 or 125 with insert fittings); or
    - ii) CAN/CSA-B137.3, “Rigid Polyvinyl Chloride (PVC) Pipe for Pressure Applications.”
  - b) for pressure *effluent distribution lateral pipe*:
    - i) CAN/CSA-B137.3, “Rigid Polyvinyl Chloride (PVC) Pipe for Pressure Applications”; or
    - ii) CAN/CSA-B137.6, “CPVC Pipe, Tubing and Fittings for Hot and Cold Water Distribution Systems”; or
  - c) pipe deemed acceptable to the *Administrator* for the intended application.

<sup>1</sup> Note: Sentence (1) — Table A.5.A. lists piping and its acceptable applications.

#### 2.5.3.2. Piping in Gravity Applications

- 1) The piping used for an *effluent sewer*, or gravity *distribution header*, shall be *certified* to one of the following standards:
  - a) CAN/CSA-B181.1, “ABS Drain, Waste, and Vent Pipe and Pipe Fittings”;<sup>1</sup>
  - b) CAN/CSA-B181.2, “PVC Drain, Waste, and Vent Pipe and Pipe Fittings”;<sup>2</sup>
  - c) CAN/CSA-B182.1, “Plastic Drain and Sewer Pipe and Pipe Fittings”;<sup>3</sup> or
  - d) CAN/CSA-B182.2, “PVC Sewer Pipe and Fittings, (PSM Type).”<sup>4</sup>
- 2) Where there is no existing standard for the intended use of a piping material, piping use shall comply with Table A.5.A., “Piping Materials.”

<sup>1,2</sup> Note: Clause (1)(a) & (1)(b) — See Appendix B-2.5.3.2.(1)(a) & B-2.5.3.2.(1)(b)

<sup>3,4</sup> Note: Clause (1)(c) & (1)(d) — See Appendix B-2.5.3.2.(1)(c) & B-2.5.3.2.(1)(d)

#### 2.5.3.3. Joints

- 1) Every joint between pipes and fittings of dissimilar materials or sizes shall be made by adapters, connectors, or mechanical joints manufactured and *certified* for that purpose.

## Section 2.6. Pressure Distribution of effluent

### 2.6.1. Pressure Distribution — Objectives and Design Requirements

#### 2.6.1.1. General

- 1) A pressure *distribution lateral pipe system* shall be designed to provide positive control of the volume of *effluent* delivered to the treatment component as determined by the design loading rate.<sup>1</sup>

<sup>1</sup> Note: Sentence (1) – See Appendix B-2.6.1.1.

#### 2.6.1.2. Orifice Discharge Volume

- 1) The volume of *effluent* discharged through any orifice in the *distribution lateral pipe system* as measured over the duration of a single dosing cycle shall not vary by more than<sup>1</sup>
  - a) 10 percent along the length of a single *distribution lateral pipe*;<sup>2</sup> and
  - b) 15 percent between all orifices in the system, unless specifically designed for in the system to accommodate variations in *soil* conditions.

<sup>1</sup> Note: Sentence (1) — When using pressure distribution laterals, the volume discharged from each orifice should not differ by more than the percentage set out in Clauses (a) and (b) except where varying soil conditions dictate that the loading rate needs to differ within the system. This may occur where soil conditions vary over the soil infiltration area. When determining the volume discharged from a single orifice, the differences in head pressure at the orifice and differences in the length of time effluent is discharged from each orifice requires consideration. In pressure delivery systems where the system supplies effluent to laterals of different lengths and relies on gravity to distribute effluent along the length of the trench, it may be necessary to vary the volume discharged at the outlet to each trench to match the desired loading rate.

<sup>2</sup> Note: Clause (1)(a) - See Appendix B-2.6.1.2.(1)(a)

#### 2.6.1.3. Effluent Pressure Distribution Lateral Pipe Objective

- 1) When secondary treated *effluent* is applied to the *soil* interface, the design and/or spacing of the orifices shall be such that the *effluent* is spread over the *soil* interface in a manner that results in a *soil* moisture content that does not vary by more than 20% over the entire *soil* interface area, as measured at a depth of 75–175 mm (3–7 in.) below the *soil* interface.<sup>1</sup>

<sup>1</sup> Note: Sentence (1) – See Appendix B-2.6.1.3.(1)

- 2) The requirements of Sentence (1) do not apply when the pressure distribution system is designed as a pressure *distribution header* to supply gravity distribution weeping lateral trenches receiving primary treated *effluent* Level 1 doses.

#### 2.6.1.4. Orifices Elevated Above infiltration Surface

- 1) Distribution lateral piping shall be installed so that each orifice opening is an adequate distance above the *soil infiltration surface* to prevent drain back into the system should intermittent ponding occur.<sup>1</sup>

<sup>1</sup> Note: Sentence (1) – See Appendix B-2.6.1.4.(1)

### 2.6.1.5. Pressure Distribution Lateral System Design

- 1) The design of a pressure *distribution lateral pipe* system shall
  - a) determine the pressure head and flow rate the pump supplying the system must be capable of by considering
    - i) static lift measured from the minimum *effluent* level in the dosing tank to the elevation of the perforated distribution piping,
    - ii) pressure head required at the orifices,
    - iii) volume discharged from orifices, and
    - iv) head loss resulting from piping at the calculated design flows using a Hazen Williams coefficient of smoothness determined for the type of piping used in the system;<sup>1</sup>
  - b) maintain a flow velocity in the piping of not less than 0.6 m/s (2 ft/s) except that in an *effluent distribution lateral pipe* this minimum velocity is required only at the supply end of the *effluent distribution lateral pipe*;<sup>2,3</sup>
  - c) maintain a flow velocity in the piping that does not exceed 1.5 m/s (5 ft/s) where the system includes any quick-closing valves;
  - d) maintain a minimum pressure head of
    - i) 1.5 m (5 ft.) at all orifices that are 4.8 mm (3/16 in.) or less in *diameter*, and
    - ii) 0.6 m (2 ft.) when orifices are larger than 4.8 mm (3/16 in.) in *diameter*;
  - e) use orifices in the lateral that are
    - i) not smaller than 3.2 mm (1/8 in.) in *diameter*, and
    - ii) spaced at a distance required to achieve the objectives of even distribution and in no case more than 1.5 m (5 ft.) apart when applying primary treated *effluent* Level 1, or more than 0.9 m (3 ft.) when applying secondary treated *effluent*;
  - f) be capable of delivering a dose volume that is equal to or less than the volume per dose required by the downstream *system* design;<sup>4</sup>
  - g) result in a *distribution lateral pipe* volume that is less than 20% of an individual dose volume;
  - h) include an *effluent* filter that prevents particles 3.2 mm (1/8 in.) in *diameter* or larger from being discharged into the *effluent* distribution *system*; and
  - i) include piping arrangements that result in components of the *system* being readily accessible from the ground surface to carry out the
    - i) flushing and cleaning of the individual laterals at the most downstream end of the lateral,
    - ii) checking of residual pressure head at both the supply end and most downstream end of the lateral, and
    - iii) regular maintenance and servicing of filters, pumps, and valves without requiring physical entry into a tank.

<sup>1</sup> Note: Subclause (1)(a)(iv) — Pipe friction loss tables can be found in Appendix A. These tables can be used to determine the size of main *effluent* supply piping and distribution headers. In large or complex systems where laterals are at different elevations, specific engineering of the system design may be required.

<sup>2</sup> Intent: Clause (1)(b) — the size of the *effluent* distribution pipe should be selected to maintain the required velocity while not exceeding pressure loss limits along the lateral.

<sup>3</sup> Note: Clause (1)(b) - See Appendix B-2.6.1.5.(1)(b)

<sup>4</sup> Intent: Clause (1)(f) — Numerous light applications of *effluent* provide better treatment conditions. The individual doses should be evenly spaced over a 24-hour period to further improve treatment.

## 2.6.2. Pressure Distribution — Prescriptive Requirements and Installation Standards

### 2.6.2.1. Design

- 1) A pressurized *distribution lateral pipe* system shall have
  - a) *distribution lateral piping* not smaller than 19 mm (3/4 in.) in *diameter*,
  - b) *distribution lateral pipe* of a size determined by Table A.1.A. for the required size and number of orifices, or by using good engineering practice that achieves the objectives of a pressure *distribution lateral pipe* system design for achieving treatment goals, and
  - c) a *distribution lateral pipe* for each chamber assembly where chambers are used.

### 2.6.2.2. Orifices

- 1) Orifices in a *distribution lateral pipe* shall<sup>1</sup>
  - a) point upwards and not form an angle greater than 45° with the vertical, except when<sup>2</sup>
    - i) required for pipe drainage, the number of orifices required for effective drainage may point downward if equipped with suitable orifice shields, or
    - ii) the lateral is encased in *drain media* all orifices may point downward,
  - b) be equipped with orifice shields to prevent blocking of the orifice when encased in *drain media*,
  - c) be spaced at a distance of not greater than
    - i) 1.5 m (5 ft.) when distributing primary treated *effluent* Level 1,
    - ii) 900 mm (36 in.) when distributing secondary treated *effluent*,
    - iii) 600 mm (2 ft.) when distributing secondary treated *effluent* with a LFH At-grade treatment system,
    - iv) 1 orifice for every 0.5 square meter (5.5 sq. ft.) when distributing *effluent* on a sand layer for a *mound*,
    - v) the distance specified when using an approved distribution method that has been tested to meet the objectives of Article 2.6.1.3., and
  - d) not exceed the maximum number of orifices specified for the pipe size as set out in Table A.1.A.

<sup>1</sup> Note: Sentence (1) - See Appendix B-2.6.2.2.

<sup>2</sup> Intent: Clause (1)(a) — Locating the orifice on the upper half of the pipe can help prevent clogging of the orifice from accumulated biological growths. Wherever the orifices are located, the orifices must be protected from rocks setting on the orifice and there must be room for the effluent to escape. The spraying effluent must not cause any erosion of the soil or sand around it.

### 2.6.2.3. Dose Volume 5 Times Pipe Volume

- 1) The volume of an individual dose to be distributed over the *soil infiltration surface* area using a pressure *distribution lateral pipe* system shall be at least 5 times the volume of the *distribution lateral pipe* but shall not exceed the maximum individual dose volume needed to deliver the required number of doses per day.

### 2.6.2.4. Lateral Length

- 1) An individual pressure *distribution lateral pipe*, as measured from the pressure distribution supply header to the last orifice, shall not exceed 20 m (65 ft.) in length.

**2.6.2.5. Pressure Head at Orifices**

- 1) The system design shall ensure a pressure head of not less than
  - a) 1.5 m (5 ft.) at orifices that are 4.8 mm (3/16 in.) in *diameter* or smaller, and
  - b) 600 mm (2 ft.) at orifices larger than 4.8 mm (3/16 in.) in *diameter*.

**2.6.2.6. Orifices Elevated Above infiltration Surface**

- 1) Where the *effluent distribution system* is designed to enable drain back of the distribution lateral piping to the dosing tank, the piping shall be installed so that each orifice opening is a minimum of 100 mm (4 in.) above the *soil infiltration surface*.<sup>1</sup>

<sup>1</sup> *Intent: Sentence (1) — The elevation above the infiltrative surface should be maximized. The orifices in the piping must be above the soil infiltration surface by an adequate distance to prevent drain back into the system if intermittent ponding were to occur on the soil infiltration surface.*

**2.6.2.7. Piping Supports**

- 1) Distribution lateral piping that is not encased in media shall be supported at intervals not greater than 1.2 m (4 ft.) or as specified by the pipe manufacturer's installation instructions.

**2.6.3. Pressure Distribution — Requirements for Materials****2.6.3.1. Piping**

- 1) Piping used in a pressure *distribution lateral pipe* system shall meet the requirements of Section 2.5.

**2.6.3.2. Effluent Filters and Service Access**

- 1) Filters used in a pressure *distribution lateral pipe* system must<sup>1</sup>
  - a) be suitable for *wastewater* applications,
  - b) provide filtration to smaller than 3.2 mm (1/8 in.) particle size,
  - c) be sized for the required flow rate of the system design and to provide a service interval frequency desired for the system, and
  - d) be located and installed so they are readily accessible from ground surface for servicing.

<sup>1</sup> *Note: Sentence (1) – See Appendix B-2.6.3.2.(1)*

**2.6.3.3. Pumps**

- 1) Pumps used in a pressure *distribution lateral pipe* system must be suitable for *wastewater* applications and able to produce the volume of *effluent* at the pressure head required by the system design.<sup>1</sup>

<sup>1</sup> *Note: Sentence (1) – See Appendix B-2.6.3.3.(1)*



## Part 3 Holding Tanks

### Section 3.1. Holding Tanks

#### 3.1.1. Holding Tanks — Objectives and Design Standards

##### 3.1.1.1. Storage Capacity

- 1) A *holding tank* serving a detached single-family *dwelling* shall have a storage capacity of not less than 4,500 L (1,000 Imp. gal).<sup>1</sup>

<sup>1</sup> *Intent: Sentence (1) - It is not the intent of this Standard to exclude the use of a septic tank as a holding tank provided the requirements of the Standard are met regarding holding tanks. The capacity of the holding tank should be large enough to make effective use of trucking service and provide a reserve volume for the owner.*

- 2) A *holding tank* for developments other than a detached single-family *dwelling* shall have a storage capacity suitable for the intended service.

##### 3.1.1.2. Infiltration/Exfiltration Prevention

- 1) *holding tank* access openings, manhole extensions, and piping connections shall prevent *infiltration* and exfiltration.
- 2) Where the site evaluation identifies high groundwater conditions at the location and elevation the tank is installed, the design of the system shall address
  - a) anti-floatation measures required;
  - b) the ability of the tank to withstand structural stresses caused by the hydrostatic pressure and buoyancy; and
  - c) maintaining the elevation of piping connections above the projected *water table*, or include other specific additional measures to ensure *infiltration* does not occur through piping connections or manhole access risers.

#### 3.1.2. Holding Tanks – Prescriptive Requirements and Installation Standards

##### 3.1.2.1. Separation Distances

- 1) *Holding tanks* shall not be located within
  - a) 10 m (33 ft.) of a *water source* or *water well*,
  - b) 10 m (33 ft.) of a *water course*,
  - c) 1 m (3.25 ft.) of a property line, and
  - d) 1 m (3.25 ft.) of a *building*.

##### 3.1.2.2. Location and Service Access

- 1) A *holding tank* shall be located and installed to accommodate the regular removal of *wastewater* by vacuum truck or other approved means.
- 2) *Holding tank* manhole access openings shall be brought to a height above the surrounding landscape that ensures surface water will not infiltrate the manhole access.

- 3) Optional *wastewater* removal openings shall be brought to a height above the surrounding landscape to prevent surface water *infiltration*.

#### 3.1.2.3. Access Opening Lid/Cover

- 1) All access openings shall be equipped with a secure lid or cover.<sup>1</sup>

<sup>1</sup> *Intent: Sentence (1) — To increase safety by preventing unauthorized or accidental entry into the access opening of a septic tank or holding tank. Acceptable protective measures include, but are not limited to, a padlock, a cover that can only be removed with tools, or a cover having a minimum weight of 29.5 kg (65 lb).*

- 2) The opening of a manhole access that extends above ground shall be insulated to an equivalent R-8 insulation value in order to protect the tank contents from freezing.

#### 3.1.2.4. Base for Holding Tank

- 1) The bottom of an excavation for a *holding tank* shall provide a uniform base to support the tank in a level position and meet the manufacturer's installation instructions.<sup>1,2</sup>

<sup>1</sup> *Intent: Sentence (1) — A tank must have a stable base so it will not settle, shift, or crack after installation.*

<sup>2</sup> *Note: Sentence (1) - See Appendix B-3.1.2.4.(1)*

#### 3.1.2.5. Insulation of Tank

- 1) A *holding tank* that has less than 1.2 m (4 ft.) of earth cover to protect it from freezing conditions shall be insulated to provide the equivalent of an R-8 insulation value at the top and sides of the tank to a minimum depth of 1.2 m (4 ft.) below *grade* or insulated in some other acceptable manner to achieve a level of protection from freezing that is equivalent to a tank that has a minimum 1.2 m (4 ft.) cover of the *in situ soil*.<sup>1</sup>

<sup>1</sup> *Note: Sentence (1) – See Appendix B-3.1.2.5.(1)*

### 3.1.3. Holding Tanks – Requirements for Materials

#### 3.1.3.1. General

- 1) A *holding tank* shall be *certified* by an accredited testing agency as meeting or exceeding the requirements of CSA-B66, Design, Material, and Manufacturing Requirements for Prefabricated Septic Tanks and Sewage Holding Tanks, as amended or replaced from time to time.<sup>1</sup>

<sup>1</sup> *Note: Sentence (1) – See Appendix B-3.1.3.1.(1)*



## Part 4 Initial Treatment Components Primary

### Section 4.1. Primary Treatment

#### 4.1.1. Primary Treatment — Objectives and Design Standards

##### 4.1.1.1. Effluent Treatment Quality

- 1) Except as permitted in Sentence (2), an initial treatment component intended to provide primary treatment of the *wastewater* prior to discharge to a *soil*-based final treatment component shall, at least 80% of the time, produce a primary treated *effluent* Level 1 having a strength that does not exceed any of the following concentrations:<sup>1</sup>
  - a) cBOD5: 150 mg/L,
  - b) TSS: 100 mg/L, and
  - c) oil and grease: 15 mg/L.

<sup>1</sup> Note: Sentence (1) – See Appendix B-4.1.1.1.(1)

- 2) The *effluent* discharged from a primary treatment component to a downstream *soil*-based component may be of a stronger *effluent* strength than set out in Sentence (1) if the design of downstream treatment component has been based on receiving that higher strength *effluent*.<sup>1</sup>

<sup>1</sup> Note: Sentence (2) – See Appendix B-4.1.1.1.(2)

##### 4.1.1.2. Sludge and Scum Accumulation

- 1) A primary treatment tank (*septic tank*) shall include the capacity to store accumulating sludge and scum for a period of at least 3 years without reducing the hydraulic retention capacity to less than the design daily peak flow.<sup>1,2</sup>

<sup>1</sup> Note: Sentence (1) — This does not set the standard of tank pumping interval at 3 years. The tank must be regularly inspected (yearly is a good target) to determine sludge depth and pumped only when needed. Depending on actual use, the frequency may vary from 1 year to 5. To minimize the amount of sludge trucked to outside treatment facilities, the tank should only be pumped when needed.

<sup>2</sup> Note: Sentence (1) - See Appendix B-4.1.1.2.

## Section 4.2. Septic Tanks

### 4.2.1. Septic Tanks — Objectives and Design Standards

#### 4.2.1.1. Working Capacity

- 1) Except where a lesser volume is allowed in Article 4.2.2.2., a primary treatment (septic) tank shall
  - a) have a minimum *working capacity* of not less than the expected daily peak *wastewater* volume determined under Section 2.2.; and
  - b) include an additional capacity of not less than
    - i) 400 L (88 Imp. gal.) per expected occupant in a residential *development* to accommodate sludge and scum accumulation,<sup>2</sup> or
    - ii) an amount required for sludge accumulation following Table A.6.A. for other than residential occupancies.
  - c) The amount of storage provided for sludge and scum accumulation shall be increased by 1.5 times when a garbage grinder is used, unless that volume has already been included in the application of the requirements in Article 2.2.2.6.

<sup>1</sup> Note: Sentence (1) - See Appendix B-4.2.1.1.(1)

<sup>2</sup> Note: Subclause (1)(b)(i) — The additional capacity of 400 L (88 Imp. gal.) per person to accommodate sludge and scum accumulation is based on the anticipated sludge and scum accumulation rate of 135 L (30 Imp. gal.) per person per year at a 95% confidence level for residential applications and a 3-year targeted pump-out interval.

#### 4.2.1.2. Service Access

- 1) The system design shall consider the location and depth below *grade* of the primary treatment component (*septic tank*) to facilitate accessibility for septage removal, service, and maintenance.<sup>1,2</sup>

<sup>1</sup> *Intent: Sentence (1) — The tank should be located where it is unlikely a deck or other structure may be built over the tank or where access may be otherwise limited for removal of septage by a vacuum truck. The depth of the tank should not exceed the practical suction elevation of vacuum trucks in order to enable septage removal.*

<sup>2</sup> Note: Sentence (1) - See Appendix B-4.2.1.2.(1)

#### 4.2.1.3. Infiltration/Exfiltration Prevention

- 1) Tank access openings, manhole extensions, and piping connections shall prevent *infiltration* and exfiltration of *wastewater* and groundwater.
- 2) Where the site evaluation identifies high groundwater conditions at the location and elevation the tank is installed, the design of the *system* shall
  - a) include the anti-floatation measures required;
  - b) ensure the tank can withstand the structural stresses caused by the hydrostatic pressure and buoyancy; and
  - c) maintain the elevation of piping connections above the projected *water table* level, or include other specific additional measures to ensure that *infiltration* does not occur through piping connections or manhole access risers.

<sup>1</sup> Note: Sentence (2) – See Appendix B-4.2.1.3.

**4.2.1.4. Insulation of Tank**

- 1) A *septic tank* shall have adequate earth cover or other means to protect it from freezing while in operation and during periods of non-use.

**4.2.2. Septic Tanks — Prescriptive Requirements and Installation Standards****4.2.2.1. Separation Distances**

- 1) Septic tanks shall not be located within
  - a) 10 m (33 ft.) of a *water source* or *water well*,
  - b) 10 m (33 ft.) of a *water course*,
  - c) 1 m (3.25 ft.) of a property line, and
  - d) 1 m (3.25 ft.) of a *building*.

**4.2.2.2. Minimum Working Capacity**

- 1) The *working capacity* of a *septic tank* shall not be less than<sup>1</sup>
  - a) the volume set out in Table 4.2.2.2. for a single-family *dwelling* or duplex, or
  - b) the volume required by Article 4.2.1.<sup>1,2</sup>

<sup>1</sup> Note: Sentence (1) - See Appendix B-4.2.2.2.

<sup>2</sup> Note: Clause 1) a) - Table 4.2.2.2. provides the working capacity volume required of the septic tank for residential applications where there are no conditions that require additional flow to be added to the peak daily volume.

<b>Table 4.2.2.2.</b> Working capacity of Septic tank	
Number of Bedrooms	Working capacity Volume
1, 2, or 3 bedrooms	3,360 L (740 Imp. gal.)
4 bedrooms	4,260 L (940 Imp. gal.)
5 bedrooms	5,220 L (1,150 Imp. gal.)
6 bedrooms	6,130 L (1,350 Imp. gal.)

**4.2.2.3. Septic Tank Manhole Access Not Buried**

- 1) *Septic tank* access openings shall not be buried and shall be located at a height above the surrounding landscape that ensures surface water will drain away from the access opening.<sup>1</sup>

<sup>1</sup> Intent: Sentence (1) — Access openings above the ground provide readily available access to the tank as compared to buried access openings, particularly when the ground is frozen. An above-ground access also encourages regular maintenance and provides a permanent and visible marker of the location of the tank.

#### 4.2.2.4. Access Opening Lid/Cover

- 1) All access openings shall be equipped with a secure, air-tight lid or cover.<sup>1</sup>

<sup>1</sup> *Intent: Sentence (1) — This requirement increases safety by preventing unauthorized or accidental entry into the access opening of a septic tank or holding tank. Acceptable protective measures include, but are not limited to, a padlock, a cover that can only be removed with tools, or a cover having a minimum weight of 29.5 kg (65 lb). The lid or cover is airtight in order to contain the odour.*

- 2) All access openings shall be insulated to provide the equivalent of an R-8 insulation value.

#### 4.2.2.5. Access Opening Extensions Water-tight

- 1) Access opening extensions shall be installed to ensure a water-tight connection to the *septic tank* and at the joints between all sections of the extensions.

#### 4.2.2.6. Insulation of Tank

- 1) A *septic tank* that has less than 1.2 m (4 ft.) of earth cover to protect it from freezing conditions shall be insulated to provide the equivalent of an R-8 insulation value over the top and sides of the tank to a minimum depth of 1.2 m (4 ft.) below *grade*, or insulated in some other acceptable manner to achieve a level of protection from freezing that is equivalent to a tank that has a minimum 1.2 m (4 ft.) cover of the *in situ soil*.

#### 4.2.2.7. Base for Septic tank

- 1) The bottom of an excavation for a *septic tank* shall provide a uniform base to support the tank in a level position and meet the manufacturer's installation instructions.<sup>1,2</sup>

<sup>1</sup> *Intent: Sentence (1) — A tank must have a stable base so it will not settle, shift, or crack after installation.*

<sup>2</sup> *Note: Sentence (1) - See Appendix B-4.2.2.7.(1)*

### 4.2.3. Septic Tanks — Requirements for Materials

#### 4.2.3.1. General

- 1) A *septic tank* shall be *certified* by an accredited testing agency as meeting or exceeding the requirements of CSA-B66, Design, Material, and Manufacturing Requirements for Prefabricated Septic Tanks and Sewage Holding Tanks, as amended or replaced from time to time.<sup>1</sup>

<sup>1</sup> *Note: Sentence (1) — See Appendix B-4.2.3.1.(1)*

## Part 5 Initial Treatment Components — Secondary Treatment

### Section 5.1. Secondary Treatment

#### 5.1.1. Secondary Treatment — Objectives and Design Standards

##### 5.1.1.1. Secondary Effluent Treatment Qualities

- 1) Except as permitted in Sentence (2), an initial treatment component intended to produce secondary treated *effluent* shall, at least 80% of the time, produce an *effluent* quality that does not exceed the appropriate values set out in Table 5.1.1.1.<sup>1</sup>

<sup>1</sup> Note: Sentence (1) — Level one treatment standard is equivalent to Primary Treatment. Thus, this table starts at Level 2.

Treatment Type <sup>2</sup>	Maximum Concentration <sup>1</sup> In Treated Effluent				
	Basic Treatment Level		Disinfection (D) <sup>3</sup>	Phosphorus Reduction (P)	Nitrogen Reduction (N)
	TSS, mg/l	CBOD <sub>5</sub> , mg/l	Fecal Coli, or E. coli, CFU/100 ml	Total Phosphorus, mg/l	Total Nitrogen
Level 2	30	25			
Level 3	15	15			
Level 4	10	10			
D-I			50 000		
D-II			200		
D-III			ND <sup>4</sup>		
P-I				1	
P-II				0.3	
N-I					50% Reduction
N-II					75% Reduction

<sup>1</sup> No tolerances apply to these requirements, because the given values take into consideration the inaccuracy of the measurement.

<sup>2</sup> A system's overall treatment classification is denoted by the applicable treatment types written in sequence, i.e. Level 2-DII-NI.

<sup>3</sup> Requirements for fecal coliform organisms or E. coli can be used for the purposes of Type D treatment. Reactivation after disinfection was not taken into consideration in establishing these requirements.

<sup>4</sup> ND = non-detectable (median < 10 CFU/100 ml).

- 2) The *effluent* produced by a secondary treatment component used in an *on-site wastewater treatment system* design may vary from the quality referred to in Sentence (1) if the design of the downstream treatment component is based on receiving *effluent* of a quality that the secondary treatment component will achieve at least 90% of the time under the operating conditions.

**5.1.1.2. Wastewater Sampling Access**

- 1) A secondary treatment component shall include sampling ports or a suitable location to obtain *wastewater* and *effluent* samples to confirm treatment performance and assess operation of the component.<sup>1</sup>

<sup>1</sup> *Intent: Sentence (1) — The system should include at least a sampling port to determine effluent quality and a sampling port for influent wastewater to assess system operation and facilitate troubleshooting of the treatment component.*

## Section 5.2. Packaged Sewage Treatment Plants

### 5.2.1. Packaged Sewage Treatment Plants — Objectives and Design Standards

#### 5.2.1.1. General

- 1) The *effluent* from a packaged *sewage* treatment plant used in an *on-site wastewater treatment system* shall discharge to a downstream *soil-based treatment system* as allowed in Part 8 or 9, and the *effluent* shall meet or exceed the *effluent* quality parameters required by the downstream final treatment components.
- 2) Except where the design of a *certified packaged sewage treatment plant* includes a pre-treatment tank or chamber, a pre-treatment tank having a *working capacity* of not less than 0.75 of the peak daily volume of design *wastewater* flow shall be installed upstream of a packaged *sewage* treatment plant.<sup>1</sup>

<sup>1</sup> Note: Sentence (2) – See Appendix B-5.2.1.1.(2)

#### 5.2.1.2. Treatment Capacity

- 1) The required treatment capacity of a *packaged sewage treatment plant* used in an *on-site wastewater treatment system* shall consider the<sup>1</sup>
  - a) expected peak hydraulic load,
  - b) expected strength of the *wastewater* from the *development*,
  - c) extent of *wastewater* flow variation throughout a day, and
  - d) variations in *wastewater* flow from day to day.

<sup>1</sup> Note: Sentence (1) – See Appendix B-5.2.1.2.(1)

#### 5.2.1.3. Accessible Location

- 1) The location of a *packaged sewage treatment plant* shall be selected with consideration to<sup>1</sup>
  - a) accessibility for regular servicing,
  - b) accessibility for periodic removal of sludge, and
  - c) minimizing concerns with periodic odour problems that may occur.

<sup>1</sup> Intent: Sentence (1) — The plant should be located where it is unlikely a deck or other structure may be built over the tank or where access may be otherwise limited for removal of sludge by a vacuum truck. The depth of the tank should not exceed the practical suction elevation of vacuum trucks at the truck access point.

#### 5.2.1.4. Insulation of Tank

- 1) A *packaged sewage treatment plant* shall have adequate earth cover or other means to protect it from freezing while in operation and during periods of non-use.

#### 5.2.1.5. Infiltration/Exfiltration Prevention

- 1) Tank access openings, manhole extensions, and piping connections shall prevent *infiltration* and exfiltration of *wastewater* and groundwater.
- 2) Where the site evaluation identifies high groundwater conditions at the location and elevation the tank is installed, the design of the system shall

- a) include any anti-flotation measures required;<sup>1</sup>
- b) ensure that the tank can withstand the structural stresses caused by the hydrostatic pressure and buoyancy; and
- c) maintain the elevation of piping connections above the projected *water table* level, or include other specific additional measures to ensure that *infiltration* does not occur through piping connections or manhole access risers.

<sup>1</sup> Note: Clause (2)(a) – See Appendix B-5.2.1.5.(2)(a)

### 5.2.2. Packaged Sewage Treatment Plants — Prescriptive Requirements and Installation Standards

#### 5.2.2.1. Separation Distances

- 1) A *packaged sewage treatment plant* shall not be located within
  - a) 10 m (33 ft.) of a *water source* or *water well*,
  - b) 10 m (33 ft.) of a *water course*,
  - c) 6 m (20 ft.) of a property line, and
  - d) 1 m (3.25 ft.) of a *building*.
- 2) Notwithstanding Sentence (1), a *packaged sewage treatment plant* may be located not less than 1 m (3.25 ft.) from a property line if
  - a) equipped with odour control mechanisms,<sup>1,2</sup>
  - b) the plant serves a *development* where the peak daily flow is less than 5.7 m<sup>3</sup> (1,250 Imp. gal.) per day, and
  - c) the strength of the *wastewater* from the *development* does not exceed *typical wastewater* strength.

<sup>1</sup> Note: Clause (2)(a) — Odour control mechanisms may include the relocation of the vent from the treatment unit to a suitable location.

<sup>2</sup> Note: Clause (2)(a) - See Appendix B-5.2.2.1.(2)(a)

- 3) Notwithstanding Sentences (1) and (2), a *packaged sewage treatment plant* serving a *development* generating more than 5.7 m<sup>3</sup> (1,250 Imp. gal.) but less than 25 m<sup>3</sup> (5,500 Imp. gal.) per day shall be located
  - a) not less than
    - i) 100 m (330 ft.) from the property line of an unrelated *development*, and
    - ii) 25 m (82 ft.) from the *development* served; or
  - b) when equipped with odour control devices, the distance may be less than set out in Clause (a)(i) but not less than 25 m (82 ft.)<sup>1</sup>

<sup>1</sup> Note: Clause (3)(b) – See Appendix B-5.2.1.1.(3)(b)

#### 5.2.2.2. Wastewater Strength

- 1) A *packaged sewage treatment plant* shall not receive *wastewater* having a strength that exceeds typical *wastewater* unless it can be demonstrated the *packaged sewage treatment plant* has the capacity to treat the *organic loading* of the *wastewater* to achieve the *effluent* quality required by these standards.<sup>1</sup>

<sup>1</sup> Note: Sentence (1) – See Appendix B-5.2.2.2.(1)



### 5.2.2.3. Treatment Capacity

- 1) A *packaged sewage treatment plant* used in an *on-site wastewater treatment system* shall have a rated treatment capacity
  - a) of not less than the expected peak volume of *wastewater* per day determined in accordance with Section 2.2., and
  - b) that meets the requirements of Article 5.2.1.2.<sup>1</sup>

<sup>1</sup> Note: Clause (1)(b) – See Appendix B-5.2.2.3.(2)(b)

### 5.2.2.4. Service Access Not Buried

- 1) *Packaged sewage treatment plant* access openings shall not be buried and shall be located at a height above the surrounding landscape that ensures surface water will drain away from the access opening.<sup>1</sup>

<sup>1</sup> Intent: Sentence (1) — To ensure an access opening for required maintenance.  
(See Appendix B-5.2.2.4.(1))

### 5.2.2.5. Access Openings Equipped with Lid/Cover

- 1) *Packaged sewage treatment plant* access openings shall be equipped with a secure lid or cover.<sup>1</sup>

<sup>1</sup> Intent: Sentence (1) — To increase safety by preventing unauthorized or accidental entry into the access opening. Acceptable protective measures include, but are not limited to, a padlock, a cover that can only be removed with tools, or a cover having a minimum weight of 29.5 kg (65 lb).

- 2) All man-way access openings shall be insulated to provide the equivalent of an R-8 insulation value.

### 5.2.2.6. Base for Packaged Sewage Treatment Plant

- 1) The bottom of an excavation for a *packaged sewage treatment plant* shall provide a uniform base to support the tank in a level position and meet the manufacturer's installation instructions.<sup>1</sup>

<sup>1</sup> Intent: Sentence (1) — A tank must have a stable base so it will not settle, shift, or crack after installation. (See Appendix B-5.2.2.6.)

### 5.2.2.7. Insulation of Tank

- 1) A *packaged sewage treatment plant* that has less than 1.2 m (4 ft.) of earth cover to protect it from freezing conditions shall be insulated to provide the equivalent of an R-8 insulation value over the top and sides of the tank to a minimum depth of 1.2 m (4 ft.) below *grade*, or insulated in some other acceptable manner in order to achieve a level of protection from freezing that is equivalent to a tank with a minimum 1.2 m (4 ft.) cover of the *in situ soil*.<sup>1</sup>

<sup>1</sup> Note: Sentence (1) – See Appendix B-5.2.2.7.(1)

**5.2.3. Packaged Sewage Treatment Plants — Requirements for Materials**

**5.2.3.1. Packaged Sewage Treatment Plant Structural Requirements and Operational Certification**

- 1) *Packaged sewage treatment plants* shall be *certified* to meet one of the following where applicable:
- a) National Sanitation Foundation (NSF/ANSI) Standard 40, Class 1, for Residential *Wastewater Treatment Systems*;
  - b) CAN/BNQ-3680-600 Standard for Onsite Residential Wastewater Treatment Technologies;
  - c) CSA B128.3 Standard for the Performance of Non-potable Water Reuse Systems;<sup>1</sup>
  - d) NSF/ANSI 350 Onsite Residential and Commercial Water Reuse Treatment Systems;<sup>2</sup> or
  - e) NSF/ANSI 350-1 Onsite Residential and Commercial Greywater Treatment Systems for Subsurface Discharge<sup>3</sup>

<sup>1</sup> Note: Clause (1)(c) – See Appendix B- 5.2.3.1.(1)(c)

<sup>2</sup> Note: Clause (1)(c) – See Appendix B- 5.2.3.1.(1)(d)

<sup>3</sup> Note: Clause (1)(c) – See Appendix B- 5.2.3.1.(1)(e)

- 2) In addition to Sentence (1), tanks used for *packaged sewage treatment plants* shall be *certified* as meeting the structural and material requirements of<sup>1</sup>
- a) CSA-B66, Design, Material, and Manufacturing Requirements for Prefabricated Septic Tanks and Sewage Holding Tanks, as amended or replaced from time to time, or
  - b) BNQ Standard NQ 3680-905/208, Prefabricated Septic Tanks for Residential Use – Dimensional and Physical Characteristics.

<sup>1</sup> Note: Article (2) - See Appendix B-5.2.3.1.(2)

## Section 5.3. Secondary Treatment — Sand Filters

### 5.3.1. Sand Filters — Objectives and Design Standards

#### 5.3.1.1. General

- 1) The treatment objective of an intermittent sand filter is to treat the *wastewater* to a secondary treated *effluent* Level 3 standard.

#### 5.3.1.2. Effluent Treatment Quality

- 1) The *effluent* produced by an intermittent *sand filter*<sup>1</sup> that receives primary treated *effluent* Level 1 shall, at least 80% of the time, be of a quality characterized by the following:
  - a) cBOD5 of less than 15 mg/L,
  - b) TSS of less than 15 mg/L,
  - c) less than 50,000 CFU/100 mL, and
  - d) oil and grease content of less than 5 mg/L.

<sup>1</sup> Note: Sentence (1) – See appendix B for sand filter cut away cross section view.

#### 5.3.1.3. Coarse-Sand Sand Filter

- 1) A coarse-sand intermittent *sand filter* shall
  - a) use filter media as specified in Sentence 5.3.3.4.(1), and
  - b) have a filter-media *infiltration* surface area that is based on
    - i) peak daily flow volumes,
    - ii) an *effluent hydraulic loading rate* of not more than 100 L per square metre (2 Imp. gal. per sq. ft.) per day, and
    - iii) an *organic loading rate* of not more than 0.015 kg cBOD5 per sq. metre per day based on peak daily flow volumes.

#### 5.3.1.4. Medium-Sand Sand Filter

- 1) A medium-sand intermittent *sand filter* shall
  - a) use filter media as specified in Sentence 5.3.3.4.(2), and
  - b) have a filter media infiltrative surface area based on
    - i) peak daily flow volumes,
    - ii) an *effluent hydraulic loading rate* of not more than 40 L per square metre (0.83 Imp. gal. per sq. ft.) per day, and
    - iii) an average *organic loading rate* of not more than 0.0075 kg cBOD5 per sq. metre per day based on peak daily flow volumes.

#### 5.3.1.5. Application of Effluent

- 1) *Effluent* shall be evenly applied to the filter media infiltrative surface using a pressure distribution lateral pipe system meeting the requirements of Section 2.6.<sup>1</sup>

<sup>1</sup> Note: Sentence (1) – See Appendix B-5.3.1.5.(1)

- 2) *Effluent* shall be applied to the filter media infiltrative surface in dose volumes that do not exceed<sup>1</sup>
  - a) 30% of the *field capacity* of the filter media per dose when using timed dosing, or
  - b) 20% of the *field capacity* of the filter media per dose when using demand dosing.

<sup>1</sup> *Intent: Sentence (2) — Numerous light applications of effluent provide better treatment conditions. This requirement results in between approximately 12 and 24 doses per day to meet the percentage of field capacity per dose. The amount may vary depending on the filter media. A timing device to control the pump is desirable to provide a wait period between each volume per flush and also to provide volumes per flush evenly spaced over a 24-hour period.*

#### 5.3.1.6. Alarm Signals

- 1) A *sand filter* shall include a device capable of
  - a) detecting a high *effluent* level condition in the *sand filter*, and
  - b) delivering a visible and audible signal to alert the user of the system that the *effluent* level is above normal operating levels.

<sup>1</sup> *Note: Sentence (1) – See Appendix B-5.3.1.6.(1)*

#### 5.3.1.7. Infiltration/Exfiltration Prevention

- 1) A *sand filter* container shall prevent the *infiltration* and *exfiltration* of water.<sup>1</sup>

<sup>1</sup> *Note: Sentence (1) — A suitable liner containing the sand filter is required to prevent the infiltration and exfiltration of water. A berm may be required on the upslope side of the sand filter to prevent surface storm water runoff from entering the sand filter.*

#### 5.3.1.8. Above Ground Filters

- 1) A *sand filter* constructed above ground or partially above ground shall
  - a) have a container that is capable of holding the filter media and withstanding hydraulic and mechanical forces that may be encountered, and
  - b) include additional insulation to minimize the effect of cold weather that is equivalent to the *soil-insulating* factor of a buried *sand filter*.

#### 5.3.1.9. Soil Cover

- 1) Where a *soil cover* is required, the *soil cover* over the *sand filter surface area* and the area immediately around it shall be graded to shed precipitation and to minimize the entrance of surface runoff water and precipitation into the *sand filter*.
- 2) Except as permitted in Sentence (3), the *soil cover* over the *sand filter* shall be a *soil texture* that allows sufficient air to enter the *sand filter media* below the *soil cover* in order to satisfy the oxygen demand created by the treatment processes in the sand filter.
- 3) A piping system may be used to supply an adequate air supply to the *sand filter media* as an alternative to the permeable *soil cover* described in Sentence (2).

#### 5.3.1.10. Open Bottom Sand Filter or Packed Bed Media Filter System Not Allowed

- 1) An open bottom *sand filter* design or other open bottom packed bed filter system shall not be used.

**5.3.2. Sand Filters — Prescriptive Requirements and Installation Standards****5.3.2.1. Separation Distances**

- 1) A *sand filter* shall not be located within
  - a) 10 m (33 ft.) of a *water source* or *water well*,
  - b) 10 m (33 ft.) of a *water course*,
  - c) 1 m (3.25 ft.) of a property line as measured from the foot of the *berm*, and
  - d) 1 m (3.25 ft.) of a *building*.

**5.3.2.2. Base for Intermittent Sand Filter**

- 1) An intermittent *sand filter* shall be on a stable and level base.

**5.3.2.3. Intermittent Sand Filter**

- 1) An intermittent *sand filter* system shall have *underdrain piping* to collect treated *effluent* that shall<sup>1</sup>
  - a) extend the full length of the *sand filter*,
  - b) be located at the bottom of the *sand filter*,
  - c) extend to the surface at both ends of the *underdrain piping*,
  - d) be located in *drain media* that has a minimum depth of 150 mm (6 in.), and
  - e) enable collection of the *effluent* at the bottom of the sand filter to ensure positive drainage to a depth of at least 200 mm (8 in.) below the sand layer.

<sup>1</sup> Note: Sentence (1) – See Appendix B-5.3.2.3.(1)

- 2) An intermittent *sand filter* system shall have a method of removing *effluent* collected at the bottom of the sand filter by the *underdrain piping* that includes the following:<sup>1,2</sup>
  - a) a pump housed in a corrosion-resistant vault that will
    - i) withstand the mechanical stresses that it will be subject to,
    - ii) prevent the migration of *drain media*, sand, or *underdrain media* to its interior, and
    - iii) provide water-tight access to finished landscape *grade* with a *diameter* equal to that of the vault; or
  - b) piping that drains to an *effluent*-dosing tank that is external to the *sand filter* where the *effluent* is removed by a pump; and
  - c) the depth of *underdrain media* and the upper operating limit of the associated-*effluent* pump cycle and alarm shall not allow *effluent* to rise within 50 mm (2 in.) of the bottom of the filter media.

<sup>1</sup> Note: Sentence (2) — The *underdrain piping* should be installed in a manner that ensures the load of the media above does not press the pipe into the bottom of the sand filter liner, effectively closing the openings in the piping; see applicable sections in the handbook for design and installation procedures.

<sup>2</sup> Note: Sentence (2) — An *underdrain pipe* laid in the centre of the sand filter along the long axis quickly collects *effluent*. If the *underdrain pipe* extends beyond the sand filter to a dose tank, care must be taken to prevent freezing of the pipe, as the trickling *effluent* will readily freeze. The pump vault may be used as the dosing tank for the downstream soil-based final treatment component if the capacity of the pump vault provides sufficient volume for the dosing of the system.

- 3) Above the *drain media*, a layer of *underdrain media* having a minimum depth of 50 mm (2 in.) shall be placed over the layer of *drain media* that supports the *sand filter media*.<sup>1</sup>

<sup>1</sup> *Intent: Sentence (3) — The media immediately under the filter media (underdrain media, which is pea gravel as specified in Sentence 5.3.3.6.(1)) should be small enough to support the filter media. Below this supporting layer, the underdrain piping should be enveloped in a coarse drain media (larger sized rock, Article 5.3.3.5.) to provide less restriction of effluent flow into the underdrain piping. The layers below the filter media must provide effective drainage to ensure aerobic conditions.*

- 4) Above the *underdrain media*, a minimum depth of 600 mm (2 ft.) of *sand filter media* shall be placed in a manner that ensures a uniform density and a top surface which is level.<sup>1</sup>

<sup>1</sup> *Note: Sentence (4) — The moisture content of the sand media may cause different placement techniques to ensure uniform density of the sand media.*

- 5) A pressurized *distribution lateral pipe system* shall be included that
- a) meets the requirements of Section 2.6.;
  - b) is situated above the filter media layer; and
  - c) is placed in
    - i) clean *drain media* with a minimum depth of 75 mm (3 in.) below the distribution lateral pipes, and that covers the orifice shields protecting the *distribution lateral pipe* orifices, or
    - ii) a chamber system that is installed in accordance with the manufacturer's instructions and covers a minimum of 90% of the filter media area.

- 6) A *geotextile fabric* shall cover the top of the *drain media* or chamber system in which the pressure *distribution lateral pipe system* is installed.

- 7) *Soil* covering the intermittent *sand filter surface area* shall
- a) have a depth of not less than 150 mm (6 in.) and not more than 300 mm (12 in.);
  - b) have a *texture* of fine sand, loamy coarse sand, loamy medium sand, or coarse sandy loam;<sup>1</sup> and
  - c) be seeded to grass or covered with sod.<sup>2</sup>

<sup>1</sup> *Intent: Clause (7)(b) — The soil covering the sand filter must be a coarse soil texture to allow a free flow of air into the sand filter.*

<sup>2</sup> *Note: Clause (7)(c) — Grass cover must be established as soon as possible to prevent erosion of the soil cover and promote the runoff of precipitation.*

- 8) There shall be monitoring ports extending from finished *grade* down to the top of the filter media layer that<sup>1</sup>
- a) are located so that there is not less than 1 per each 3 m by 3 m (10 ft. by 10 ft.) area of sand layer;
  - b) are located in each continuous row of chambers, if chambers are used;
  - c) have a minimum *diameter* of 100 mm (4 in.);
  - d) have horizontal or vertical saw cuts from the bottom of the pipe to a height of 100 mm (4 in.) to allow the entry of *effluent*;
  - e) are accessible from the surface; and
  - f) are equipped with removable caps.

<sup>1</sup> *Note: Sentence (8) – See Appendix B-5.3.2.3.(8)*

**5.3.2.4. Distribution Laterals**

- 1) The *distribution lateral pipe system* used to spread the *effluent* over the *sand filter surface area* shall meet the requirements of Section 2.6. and shall be designed so that<sup>1</sup>
  - a) there is not less than 1 orifice for
    - i) each 0.55 m<sup>2</sup> (6 ft<sup>2</sup>) of filter media surface *infiltration* area in a medium sand sand filter; or
    - ii) each 0.18 m<sup>2</sup> (2 ft<sup>2</sup>) of filter media surface *infiltration* area in a coarse sand sand filter;
  - b) each orifice serves an area whose length does not exceed its width by more than 1.5 times; and
  - c) the orifices in adjacent laterals create an offset pattern to maximize distribution.

<sup>1</sup> Note: Sentence (1) – See Article 5.3.2.4.(1)

**5.3.2.5. Above Ground**

- 1) A *sand filter* constructed entirely or partially above ground shall be insulated with polystyrene that provides a minimum R-8 insulation value, and shall be provided with a surrounding *soil berm* having a slope not steeper than 1 vertical to 3 horizontal, or a concrete enclosure having the structural capacity to carry the loads placed on walls.

**5.3.3. Sand Filters — Requirements for Materials****5.3.3.1. Underdrain Piping**

- 1) *Underdrain piping* shall
  - a) not be smaller than NPS 4 in. pipe with saw cuts halfway through the piping at approximately 50 mm (2 in.) spacing, or
  - b) be an alternative product that will effectively collect *effluent* from below the filter media without clogging.

**5.3.3.2. Sand Filter Container**

- 1) A *sand filter* container shall be
  - a) a reinforced concrete container;
  - b) constructed of other materials that will provide an equivalent performance in which water tightness is expected; or
  - c) a flexible membrane liner having properties that are at least equivalent to 0.76 mm or 760 µm thick (0.03 in.) unreinforced polyvinyl chloride (PVC), protected by a 75 mm (3 in.) thick sand layer beneath the liner.

**5.3.3.3. Test for Media**

- 1) The *sand filter media*, *drain media*, and *underdrain media* specified in Articles 5.3.3.4., 5.3.3.5., and 5.3.3.6., respectively, shall be tested to determine conformance
  - a) in accordance with ASTM C-136, “Standard Test Method for Sieve Analysis of Fine and Coarse Aggregates,” and in conjunction and accordance with ASTM C-117, “Standard Test Method for Materials Finer than No. 200 Sieve in Mineral Aggregates by Washing”; and
  - b) by a qualified third party.

**5.3.3.4. Filter Media**

- 1) Except as permitted in Sentence (3), the sand used as filter media in a coarse-sand *sand filter* shall be well-washed and consist of the following particle size:
  - a) 100 percent passing the 9.51 mm (3/8 in.) sieve;
  - b) 77 to 100 percent passing the 4.76 mm (0.187 in.), No. 4 sieve;
  - c) 53 to 100 percent passing the 2.36 mm (0.0937 in.), No. 8 sieve;
  - d) 15 to 80 percent passing the 1.18 mm (0.0469 in.), No. 16 sieve;
  - e) 3 to 50 percent passing the 0.6 mm (0.0234 in.), No. 30 sieve;
  - f) 0 to 2 percent passing the 0.3 mm (0.0117 in.), No. 50 sieve'
  - g) 0 to 1 percent passing the 0.15 mm (0.0059 in.), No. 100 sieve; and
  - h) concrete sand specification provided in CAN/CSA-A23.1, "Concrete Materials and Methods of Concrete Construction."
  
- 2) Except as permitted in Sentence (3), the sand used as filter media in a medium-sand *sand filter* shall be well-washed and have a particle size that meets the following criteria:
  - a) 100 percent passing the 9.51 mm (3/8 in.) sieve;
  - b) 95 to 100 percent passing the 4.76 mm (0.187 in.), No. 4 sieve;
  - c) 80 to 100 percent passing the 2.36 mm (0.0937 in.), No. 8 sieve;
  - d) 45 to 85 percent passing the 1.18 mm (0.0469 in.), No. 16 sieve;
  - e) 15 to 60 percent passing the 0.6 mm (0.0234-in.), No. 30 sieve;
  - f) 3 to 10 percent passing the 0.3-mm (0.0117-in.), No. 50 sieve;
  - g) 0 to 1 percent passing the 0.15-mm (0.0059 in.), No. 100 sieve; and
  - h) concrete sand specification provided in CAN/CSA-A23.1 Concrete Construction.
  
- 3) An alternative media to what is provided in Sentences (1) and (2) may be used as the filter media provided it
  - a) is of equivalent durability,
  - b) has a particle *size* consistent with the *size* required for use in a coarse sand sand filter or medium-sand *sand filter*,
  - c) is inert so that it will maintain its integrity and not collapse or disintegrate with time, and
  - d) is not detrimental to the performance of the intermittent *sand filter*.

**5.3.3.5. drain media**

- 1) Except as permitted in Sentence (2), *drain media* shall be clean, washed *gravel*; clean, crushed rock; or other equivalent media for distributing *effluent*, with particle size of the following consistency:
  - a) 100 percent passing the 38.1 mm (1-½ in.) sieve,
  - b) 50 to 100 percent passing the 9.51 mm (3/8 in.) sieve;
  - c) 6 to 84 percent passing the 4.76 mm (0.187 in.), No. 4 sieve;
  - d) 0 to 24 percent passing the 2.36 mm (0.0937 in.), No. 8 sieve; and
  - e) 0 to 1 percent passing the 1.18 mm (0.0469 in.), No. 16 sieve.
  
- 2) An alternative media to what is provided in Sentence (1) may be used provided it
  - a) is of equivalent durability,
  - b) has a particle *size* consistent with the size set out in Sentence (1),
  - c) is inert so that it will maintain its integrity and not collapse or disintegrate with time, and
  - d) is not detrimental to the treatment performance of the system.



**5.3.3.6. Underdrain media**

- 1) *Underdrain media* shall be clean, washed pea *gravel*, or equivalent material with a particle size of the following consistency:
  - a) 100 percent passing the 12.7 mm (½ in.) sieve;
  - b) 50 to 100 percent passing the 9.51 mm, (3/8 in.) sieve;
  - c) 6 to 84 percent passing the 4.76 mm (0.187 in.), No. 4 sieve;
  - d) 0 to 24 percent passing the 2.36 mm (0.0937 in.), No. 8 sieve; and
  - e) 0 to 1 percent passing the 1.18 mm (0.0469 in.), No. 16 sieve.

## Section 5.4. Secondary Treatment — Re-circulating Gravel Filters

### 5.4.1. Re-circulating Gravel Filters — Objectives and Design Standards

#### 5.4.1.1. General

- 1) The treatment objective of a re-circulating *gravel* filter shall be to treat the *wastewater* to a *secondary treated effluent* Level 2 standard.

#### 5.4.1.2. Infiltration Surface Area

- 1) A *re-circulating gravel filter* using a minimum filter depth media of 600 mm (2 ft.), as specified in Article 5.4.3.4., shall be designed to have a filter media infiltrative surface area based on
  - a) peak daily flow volumes,
  - b) an *effluent hydraulic loading rate* of not more than 200 L/m<sup>2</sup> (4 Imp. gal./ft<sup>2</sup>) per day, and
  - c) an *organic loading rate* of not more than 0.04 kg cBOD<sub>5</sub> /m<sup>2</sup> per day.

#### 5.4.1.3. Application of Effluent

- 1) *Effluent* shall be evenly applied to the filter-media-layer infiltrative surface using a pressure *distribution lateral pipe* system meeting the requirements of Section 2.6. and Article 5.3.2.4.
- 2) *Effluent* shall be applied to the filter-media infiltrative surface in doses that<sup>1</sup>
  - a) occur not less than 48 times per day,
  - b) occur at intervals of not more than 30 minutes, and
  - c) do not exceed 8 L (1.76 Imp. gal.) discharged from a single orifice per dose.

<sup>1</sup> *Intent: Sentence (2) — Numerous light applications of effluent provide better treatment conditions. A timing device to control the pump is desirable to provide a wait period between each volume per flush and also to provide volumes per flush evenly spaced over a 24-hour period.*

#### 5.4.1.4. Effluent Tank

- 1) A *re-circulating gravel filter* design shall include a mixing/re-circulation *effluent tank* that
  - a) has a capacity of 150 percent of peak daily flow volume for residential applications,
  - b) has a capacity of 100 percent peak daily flow volume for commercial applications,
  - c) receives *effluent* from the upstream *primary treatment* component,
  - d) receives *effluent* from the *re-circulating gravel filter*, and
  - e) includes components required to achieve a 4 to 1 re-circulation ratio.

#### 5.4.1.5. Minimum of 1 Pass before Discharge

- 1) The *re-circulating gravel filter* design shall ensure *effluent* has passed through the *gravel* filter at least once prior to discharge to a downstream treatment system component.

#### 5.4.1.6. Detection/Alarm

- 1) A *re-circulating gravel filter* shall include a device capable of
  - a) detecting a high *effluent*-level condition, and
  - b) delivering a visible and audible signal to alert the user(s) of the system that the *effluent* level is above normal operating levels.

**5.4.1.7. Infiltration/Exfiltration Prevention**

- 1) A *re-circulating gravel filter* container shall prevent the *infiltration* and exfiltration of water.

**5.4.1.8. Above Ground**

- 1) A *re-circulating gravel filter* constructed above ground or partially above ground shall
  - a) have a container that is capable of holding the filter media and withstanding hydraulic and mechanical forces that may be encountered, and
  - b) provide insulation from cold weather equivalent to the *soil* insulating factor of a buried *gravel filter*.

**5.4.1.9. Open Bottom Re-circulating Gravel Filter Not Allowed**

- 1) An open bottom *re-circulating gravel filter* design shall not be used.

**5.4.1.10. Soil Cover**

- 1) Where a *soil cover* is required, the *soil cover* over a *re-circulating gravel filter* and the area immediately around it shall be graded to shed precipitation and prevent surface-water run-off from entering the *re-circulating gravel filter*.

**5.4.2. Re-circulating Gravel Filters — Prescriptive Requirements and Installation Standards****5.4.2.1. Separation Distances**

- 1) A *re-circulating gravel filter* shall not be located within
  - a) 10 m (33 ft.) of a *water source* or *water well*,
  - b) 10 m (33 ft.) of a *water course*,
  - c) 3 m (10 ft.) of a property line measured from the foot of the *berm*, and
  - d) 1 m (3.25 ft.) of a *building*.
- 2) Notwithstanding Sentence (1), a *re-circulating gravel filter* designed to treat in excess of 5.7 m<sup>3</sup> (1,250 Imp. gal.) per day shall be located a sufficient additional distance away from *buildings* and *property lines* to ensure that odour impact is minimized.

**5.4.2.2. Base for Filter**

- 1) A *re-circulating gravel filter* shall be on a stable and level base.

**5.4.2.3. Re-Circulating Gravel Filter System**

- 1) A *re-circulating gravel filter system* shall contain *underdrain piping* to collect *effluent* that shall
  - a) be located at the bottom of the *re-circulating gravel filter*,
  - b) extend the full length of the *re-circulating gravel filter*,
  - c) extend to the surface at both ends of the underdrain pipe,
  - d) provide positive drainage to a depth of at least 200 mm (8 in.) below the filter media layer, and
  - e) connect to a pump vault within the *re-circulating gravel filter*, or extend beyond the edge of the *re-circulating gravel filter* to provide gravity drainage to the mixing/re-circulation tank.

<sup>1</sup> *Note: Sentence (1) — An underdrain pipe laid in the centre of the re-circulating gravel filter along the long axis collects effluent quickly.*

- 2) A re-circulating gravel filter system shall contain pumps and control systems that shall ensure that the effluent collected in the bottom on the gravel filter does not come to within 50 mm (2 in.) of the bottom of the filter media.
- 3) The layer of *drain media* containing the *underdrain piping* shall have a minimum depth of 150 mm (6 in.).
- 4) The layer of *drain media* referred to in Sentence (3) shall be covered with a layer of *underdrain media* specified in Article 5.3.3.6. having a minimum depth of 50 mm (2 in.).<sup>1</sup>

<sup>1</sup> *Intent: Sentence (4) — The media immediately under the filter media (underdrain media, which is pea gravel as specified in Sentence 5.3.3.6.(1) should be small enough to support the filter media. Below this supporting layer, the underdrain piping should be enveloped in a coarse drain media (larger sized rock, Article 5.3.3.5.) to provide less restriction of effluent flow into the underdrain piping. The layers below the filter media must provide effective drainage to ensure aerobic conditions.*

- 5) A minimum of 600 mm (2 ft.) of filter media above the *underdrain media* shall have a level surface and be placed in a manner to ensure uniform density.
- 6) A pressurized *distribution lateral pipe system* shall be installed that
  - a) is situated above the filter media layer,
  - b) is placed in clean *drain media* with a minimum depth of 75 mm (3 in.) below the distribution lateral pipes, and that covers the orifice shields, or
  - c) when placed in a chamber system, the chambers shall
    - i) be installed in accordance with the manufacturer's instructions,
    - ii) cover a minimum of 90% of the gravel area, and
    - iii) be set on a minimum of 50 mm (2 in.) of *drain media* covering the filter media layer.
- 7) A *geotextile fabric* shall cover the top of the *drain media* or chamber system in which the pressure *distribution lateral pipe system* is installed.
- 8) The re-circulating gravel filter area shall be covered by a layer of soil that
  - a) has a depth of not less than 150 mm (6 in.) and not more than 300 mm (12 in.),
  - b) is of a *soil texture classification* no finer than loamy coarse sand,<sup>1</sup> and
  - c) has been seeded to grass or covered with sod.<sup>2</sup>

<sup>1</sup> *Intent: Clause (8)(b) — The soil covering the re-circulating gravel filter must be very coarse to allow a free flow of air into the gravel filter.*

<sup>2</sup> *Note: Clause (8)(c) — Grass cover must be established as soon as possible to prevent erosion of the soil cover.*

- 9) There shall be 2 monitoring ports with a minimum diameter of 100 mm (4 in.) that are accessible from the surface and extend down to the top of the filter media layer.

#### **5.4.2.4. Orifice Spacing**

- 1) The *distribution lateral pipe system* shall be designed so that
  - a) there is not less than 1 orifice for each 0.18 m<sup>2</sup> (2 ft.<sup>2</sup>) of filter media surface *infiltration area*,
  - b) each orifice serves an area whose length does not exceed its width by more than 1.5 times, and
  - c) the orifices in adjacent laterals create an offset pattern to maximize distribution.

#### 5.4.2.5. Pumps

- 1) Where collected *effluent* is removed from the *re-circulating gravel filter* using a pump located within the *gravel filter*,
  - a) the pump and related apparatus shall be housed in a corrosion resistant vault designed to
    - i) withstand the stresses placed upon it,
    - ii) prevent the migration of *drain media, gravel, or underdrain media* to its interior, and
    - iii) provide water-tight access to finished landscape *grade* with a *diameter* equal to that of the vault, and
  - b) the depth of *underdrain media* and the operating level of the pump cycle and alarm shall not allow *effluent* to rise within 50 mm (2 in.) of the bottom of the filter media.

#### 5.4.2.6. Above Ground Containment

- 1) A *re-circulating gravel filter* constructed entirely or partially above ground shall be
  - a) provided with a
    - i) surrounding *soil berm* having a slope not steeper than 1 vertical to 3 horizontal, or
    - ii) concrete enclosure having the structural capacity to carry the loads placed on walls, and
  - b) insulated with polystyrene or equivalent on the walls of the enclosure that provides a minimum R-8 insulation value.<sup>1</sup>

<sup>1</sup> Note: Clause (1)(b) – See Appendix B-5.4.2.6.(1)(b)

### 5.4.3. Re-circulating Gravel Filters — Requirements for Materials

#### 5.4.3.1. Underdrain Piping

- 1) *Underdrain piping* shall not be smaller than NPS 4 inch pipe with saw cuts halfway through the pipe at approximately 50 mm (2 in.) spacing.

#### 5.4.3.2. Re-Circulating Gravel Filter Container

- 1) A *re-circulating gravel filter* container shall be constructed of
  - a) reinforced concrete or materials that will provide performance and water tightness equivalent to a reinforced concrete container, or
  - b) a flexible membrane liner
    - i) having properties that are at least equivalent to 0.762 mm or 762 µm thick (0.03 in.) unreinforced polyvinyl chloride (PVC), and
    - ii) protected by a 75 mm (3 in.) layer of sand beneath the liner that is adequately supported by structurally sufficient sidewall supports provided by void forms when further supported by surrounding earth *berms* or concrete walls.

**5.4.3.3. Test Requirements for Gravel Filter Media**

- 1) The *re-circulating gravel filter* media shall be tested to determine conformance with the criteria outlined in Article 5.4.3.4. by a sieve analysis test
  - a) in accordance with ASTM C-136, "Standard Test Method for Sieve Analysis of Fine and Coarse Aggregates," and in conjunction with ASTM C-117, "Standard Test Method for Materials Finer than No. 200 Sieve in Mineral Aggregates by Washing"; and
  - b) performed by a qualified third party.

**5.4.3.4. Gravel Filter Media**

- 1) The *gravel* used as filter media shall
  - a) be washed *gravel* consisting of the following particle sizes:
    - i) 100 percent passing the 9.50 mm (3/8 in.) sieve;
    - ii) 0 to 95 percent passing the 4.76 mm (0.187 in.), No. 4 sieve;
    - iii) 0 to 2 percent passing the 2.36 mm (0.0937 in.), No. 8 sieve; and
    - iv) 0 to 1 percent passing the 0.6 mm (0.0234 in.), No. 30 sieve.
- 2) An alternative media to what is provided in Sentence (1) may be used as filter media if it
  - a) is of equivalent durability,
  - b) has a particle-size distribution consistent with the particle-size distribution required for use in a *re-circulating gravel filter*,
  - c) is inert so that it will maintain its integrity and not collapse or disintegrate with time, and
  - d) is not detrimental to the performance of the *re-circulating gravel filter*.

## Part 6 Initial Treatment Components — Effluent and Pre-treatment Tanks

### Section 6.1. Effluent Tanks

#### 6.1.1. Effluent Tanks — Objectives and Design Standards

##### 6.1.1.1. General

- 1) The objective of an *effluent tank* is to retain *effluent* in order to enable the effective delivery of *effluent* in dosed volumes to a downstream component.<sup>1</sup>

<sup>1</sup> Note: Sentence (1) – See Appendix B-6.1.1.1.

##### 6.1.1.2. Tank Capacity

- 1) *Effluent tanks* using timed dosing shall have a capacity of 2 times the average daily flow at maximum occupancy plus the allowance for any other high volume fixtures.
- 2) *Effluent tanks* using demand dosing shall have the capacity required by the downstream component.
- 3) All *effluent tanks* shall include a volume for emergency storage after alarm conditions.

##### 6.1.1.3. Infiltration/Exfiltration Prevention

- 1) *Effluent tank* access openings and manhole extensions and piping connections shall prevent *infiltration* and exfiltration.
- 2) Where the site evaluation identifies high groundwater conditions at the location and elevation the tank is installed, the design of the system shall
  - a) include any anti-floatation measures required;<sup>1</sup>
  - b) ensure that the tank can withstand structural stresses caused by the hydrostatic pressure and buoyancy; and
  - c) maintain the elevation of piping connections above the projected *water table* level, or include other specific additional measures to ensure that *infiltration* does not occur through piping connections or manhole access risers.

<sup>1</sup> Note: Clause (2)(a) –consult the manufacturer of the tank to confirm the tank's suitability to the condition it is installed in and acceptable anti-floatation methods for the tanks are used.

##### 6.1.1.4. Insulation of Tank

- 1) An *effluent tank* shall have adequate earth cover or other means to protect it from freezing while in operation and during periods of non-use.

**6.1.2. Effluent Tanks — Prescriptive Requirements and Installation Standards**

**6.1.2.1. Separation Distances**

- 1) *Effluent tanks* shall not be located within
  - a) 10 m (33 ft.) of a *water source* or *water well*,
  - b) 10 m (33 ft.) of a *water course*,
  - c) 1 m (3.25 ft.) of a property line, and
  - d) 1 m (3.25 ft.) of a *building*.

**6.1.2.2. Service Access**

- 1) *Effluent tank* access openings shall not be buried and shall be located at a height above the surrounding landscape that ensures surface water will drain away from the access opening.<sup>1</sup>

<sup>1</sup> *Intent: Sentence (1) — Aboveground access openings provide readily available access to the tank as compared to buried access openings, particularly when the ground is frozen. Aboveground access also encourages regular maintenance and provides a permanent and visible marker of the location of the tank.*

- 2) All access openings shall be insulated to provide the equivalent of an R-8 insulation value.

**6.1.2.3. Access Openings Equipped with Lid/Cover**

- 1) All access openings shall be equipped with a secure lid or cover.<sup>1</sup>

<sup>1</sup> *Intent: Sentence (1) — To increase safety by preventing unauthorized or accidental entry into the access opening. Acceptable protective measures include, but are not limited to, a padlock, a cover that can only be removed with tools, or a cover with a minimum weight of 29.5 kg (65 lb).*

**6.1.2.4. Base for Effluent Tank**

- 1) The bottom of an excavation for an *effluent tank* shall provide a uniform base to support the tank in a level position and meet the manufacturer's installation instructions.<sup>1</sup>

<sup>1</sup> *Intent: Sentence (1) — A tank must have a stable base so it will not settle, shift, or crack after installation.*

**6.1.2.5. Insulation of Tank**

- 1) An *effluent tank* with less than 1.2 m (4 ft.) of earth cover to protect it from freezing conditions shall be insulated to provide the equivalent of an R-8 insulation value at the top and sides of the tank to a minimum depth of 1.2 m (4 ft.) below *grade*, or insulated in some other acceptable manner so as to achieve a level of protection from freezing that is equivalent to a tank with a minimum 1.2 m (4 ft.) cover of the in situ *soil*.



**6.1.3. Effluent Tanks — Requirements for Materials**

**6.1.3.1. General**

- 1) An *effluent tank* shall be *certified* by an accredited testing agency as meeting or exceeding the structural and material requirements of CSA-B66, “Design, Material, and Manufacturing Requirements for Prefabricated Septic Tanks and Sewage Holding Tanks,” as amended or replaced from time to time.<sup>1</sup>

<sup>1</sup> Note Sentence (1) – See Appendix B-6.1.3.1.(1)

## Section 6.2. Settling Tanks (Pre-Treatment)

### 6.2.1. Settling Tanks — Objectives and Design Requirements

#### 6.2.1.1. General

- 1) The objective of a *settling tank* is to reduce the strength of *wastewater* to a level that is suitable for the downstream component; it may also be used as an *equalization tank* to enable flow equalization with or without the objective of reducing the *wastewater* strength.<sup>1</sup>

<sup>1</sup> Note: Sentence (1) – See Appendix B-6.2.1.1.(1)

#### 6.2.1.2. Settling Tank Used as Pre-aeration Tank

- 1) A *settling tank* may be used as a pre-aeration tank where required by the *system* design.

#### 6.2.1.3. Capacity

- 1) *Settling tanks* shall have the capacity to pre-treat and manage the *wastewater* flow as required by the downstream component and system design.

#### 6.2.1.4. Infiltration/Exfiltration Prevention

- 1) *Settling tank* access openings, manhole extensions, and piping connections shall prevent *infiltration* and exfiltration.
- 2) Where the site evaluation identifies high groundwater conditions at the location and elevation the tank is installed, the design of the system shall<sup>1</sup>
  - a) include any anti-floatation measures required;
  - b) ensure that the tank can withstand structural stresses caused by hydrostatic pressure and buoyancy; and
  - c) maintain the elevation of piping connections above the projected *water table* level, or include other specific additional measures to ensure that *infiltration* does not occur through piping connections or manhole access risers.

<sup>1</sup> Note: Sentence (2) – See Appendix B-6.2.1.4.(2)

#### 6.2.1.5. Insulation of Tank

- 1) A *settling tank* shall have adequate earth cover or other means to protect it from freezing while in operation and during periods of non-use.

#### 6.2.1.6. Service Access

- 1) The system design shall consider the location and depth below *grade* of the *settling tank* to facilitate accessibility for septage removal, service, and maintenance.<sup>1</sup>

<sup>1</sup> Intent: Sentence (1) — The tank should be located where it is unlikely that a deck or other structure will be built over the tank or where access may be otherwise limited for removal of septage by a vacuum truck. The depth of the tank should not exceed the practical suction elevation of vacuum trucks in order to enable septage removal.

**6.2.2. Settling Tanks — Prescriptive Requirements and Installation Standards****6.2.2.1. Separation Distances**

- 1) Settling tanks shall not be located within
  - a) 10 m (33 ft.) of a *water source* or *water well*,
  - b) 10 m (33 ft.) of a *water course*,
  - c) 1 m (3.25 ft.) of a *property* line, and
  - d) 1 m (3.25 ft.) of a *building*.
  
- 2) Notwithstanding Sentence (1), a *settling tank* that includes pre-aeration in its function shall not be located within
  - a) 10 m (33 ft.) of a *water source* or *water well*,
  - b) 10 m (33 ft.) of a *water course*,
  - c) 6 m (20 ft.) of a *property* line, and
  - d) 1 m (3.25 ft.) of a *building*.
  
- 3) Notwithstanding Sentences (1) and (2), a *settling tank* that includes pre aeration in its function may be located not less than 1 m (3.25 ft.) from a *property* line if
  - a) equipped with odour control mechanisms,
  - b) the plant serves a *development* where the peak daily flow is less than 5.7 m<sup>3</sup> (1,250 Imp. gal.) per day, and
  - c) the strength of the *wastewater* from the *development* does not exceed *typical wastewater* strength.
  
- 4) Notwithstanding Sentences (1), (2), and (3), a *settling tank* that includes pre aeration in its function, and serves a *development* generating more than 5.7 m<sup>3</sup> (1,250 Imp. gal.) but less than 25 m<sup>3</sup> (5,500 Imp. gal.) per day, shall be located
  - a) if not equipped with odour control devices, not less than<sup>1</sup>
    - i) 100 m (330 ft.) from the property line of an unrelated *development*, and
    - ii) not less than 25 m (82 ft.) from the *development* served; or
  - b) when the *settling tank* is equipped with odour control devices, the distance from the property line of unrelated *development* may be reduced to a minimum of 25 m (82 ft.)

<sup>1</sup> Note: Clause (4)(a) – See Appendix B-6.2.3.1.(1)

**6.2.2.2. Access Openings Above Ground**

- 1) *Settling tank* access openings shall not be buried and shall be located at a height above the surrounding landscape that ensures surface water will drain away from the access opening.<sup>1</sup>

<sup>1</sup> Intent: Sentence (1) — Access openings above the ground provide readily available access to the tank as compared to buried access openings, particularly when the ground is frozen. Aboveground access also encourages regular maintenance and provides a permanent and visible marker of the location of the tank.

- 2) All access openings shall be insulated to provide the equivalent of an R-8 insulation value.

### 6.2.2.3. Access Openings Equipped with a Secure Lid/Cover

- 1) All access openings shall be equipped with a secure lid or cover.<sup>1</sup>

<sup>1</sup> *Intent: Sentence (1) — To increase safety by preventing unauthorized or accidental entry into the access opening of a settling tank. Acceptable protective measures include, but are not limited to, a padlock, a cover that can only be removed with tools, or a cover with a minimum weight of 29.5 kg (65 lb).*

### 6.2.2.4. Base for Settling Tank

- 1) The bottom of an excavation for a *settling tank* shall provide a uniform base to support the tank in a level position and meet the manufacturer's installation instructions.<sup>1</sup>

<sup>1</sup> *Intent: Sentence (1) — A tank must have a stable base so it will not settle, shift, or crack after installation.*

### 6.2.2.5. Protection from Freezing

- 1) A *settling tank* with less than 1.2 m (4 ft.) of earth cover to protect it from freezing conditions shall be insulated to provide the equivalent of an R-8 insulation value over the top and sides of the tank to a minimum depth of 1.2 m (4 ft.) below *grade*, or insulated in some other acceptable manner to achieve a level of protection from freezing that is equivalent to a tank that has a minimum 1.2 m (4 ft.) cover of the *in situ soil*.

## 6.2.3. Settling Tanks — Requirements for Materials

### 6.2.3.1. General

- 1) A *settling tank* shall be *certified* by an accredited testing agency as meeting or exceeding the structural and material requirements of CSA-B66, "Design, Material, and Manufacturing Requirements for Prefabricated Septic Tanks and Sewage Holding Tanks," as amended from time to time.<sup>1</sup>

<sup>1</sup> *Note: Sentence (1) — See Appendix B-6.2.3.1.(1)*

## Section 6.3. Lift Stations

### 6.3.1. Lift Stations - Objectives and Design Requirements

#### 6.3.1.1. General

- 1) The objective of a *lift station* is to accumulate incoming raw *wastewater*, which is then periodically pumped to a higher elevation where it enters other components or sewer lines in the *wastewater* management and treatment *system*.<sup>1</sup>

<sup>1</sup> Note: Sentence (1) – See Appendix B-6.3.1.1.(1)

- 2) The design capacity and pumping controls used with the *lift Station* shall be capable of supplying small doses of *wastewater* to the downstream component to prevent large amounts of *wastewater* discharged at rapid transfer rates that may overload the capacity of the downstream components.<sup>1</sup>

<sup>1</sup> Note: Sentence (2) - The design capacity of the *lift Station* should consider the need for and volume required to provide some emergency storage in the event of a pump failure or power outage.

#### 6.3.1.2. Infiltration/Exfiltration Prevention

- 1) *Lift station* tank access openings, manhole extensions, and piping connections shall prevent *infiltration* and exfiltration.<sup>1</sup>

<sup>1</sup> Note: Sentence (1) – See Appendix B-6.3.1.2.(1)

- 2) Where the site evaluation identifies high groundwater conditions at the location and elevation the tank is installed the design of the *system* shall<sup>1</sup>
  - a) include any anti-floatation measures required;
  - b) ensure that the tank can withstand structural stresses caused by the hydrostatic pressure and buoyancy; and
  - c) maintain the elevation of piping connections above the projected *water table* level, or include other specific additional measures to ensure that *infiltration* does not occur through piping connections or manhole access risers.

<sup>1</sup> Note: Sentence (2) – See Appendix B-6.3.1.2.(2)

#### 6.3.1.3. Insulation of Tank

- 1) A *lift station* that has less than 1.2 m (4 ft.) of earth cover to protect it from freezing conditions shall be protected to provide the equivalent of an R-8 insulation value over the top and sides of the tank to a minimum depth of 1.2 m (4 ft.) below *grade*, or insulated in some other acceptable manner to achieve a level of protection from freezing that is equivalent to a tank that has a minimum of 1.2 m (4 ft.) cover of the in situ *soil*.

#### 6.3.1.4. Service Access

- 1) *Lift station* access openings shall not be buried and shall be located at a height above the surrounding landscape that ensures surface water will drain away from the access opening.<sup>1</sup>

<sup>1</sup> *Intent: Sentence (1) — The tank should be located where it is unlikely that a deck or other structure will be built over the tank or where access for service may be otherwise limited.*

### 6.3.2. Lift Stations — Prescriptive Requirements and Installation Standards

#### 6.3.2.1. Separation Distances

- 1) *Lift stations* shall not be located within<sup>1</sup>
  - a) 10 m (33 ft.) of a *water source* or *water well*,
  - b) 10 m (33 ft.) of a *water course*,
  - c) 1 m (3.25 ft.) of a *property* line, and
  - d) 1 m (3.25 ft.) of a *building*.

<sup>1</sup> *Note: Sentence (1) – See Appendix B-6.3.2.1.(1).*

- 2) Notwithstanding Sentence (1), if a *lift station* tank also provides another function, such as pre-treatment or equalization, the requirements for that other type of tank shall apply.

### 6.3.3. Lift Stations – Requirements for Materials

#### 6.3.3.1. General

- 1) A *lift station* tank shall be *certified* by an accredited testing agency as meeting or exceeding the structural and material requirements of CSA-B66, “Design, Material, and Manufacturing Requirements for Prefabricated Septic Tanks and Sewage Holding Tanks,” as amended or replaced from time to time.<sup>1</sup>

<sup>1</sup> *Note: Sentence (1) – See Appendix B-6.3.3.1.(1)*

## Part 7 Site Evaluation

### Section 7.1. Site Characteristics and Evaluation Procedures

#### 7.1.1. Site Characteristics and Evaluation Procedures — Objectives and Design Standards

##### 7.1.1.1. General

- 1) The objective of a site evaluation is to assess and quantify the capability of the site to infiltrate and disperse the *effluent* load into the *soil* in a manner that achieves the treatment objectives in the *soil* within the performance boundaries set for the *on-site wastewater treatment system*.<sup>1</sup>

<sup>1</sup> *Intent: Sentence (1) — The site’s “capability” to treat wastewater is a combination of the site’s ability to accept the wastewater load, meet separation distances to other features, and contain the depth of suitable soil needed to achieve treatment. For example, the soil may be able to accept the wastewater load without surfacing but a sufficient depth of unsaturated soil may or may not exist under the proposed hydraulic loading to provide final treatment of the wastewater. Together, all of the site characteristics will determine the suitability of a site for a particular treatment system design. (See Appendix B-7.1.1.1.(1).*

##### 7.1.1.2. Site Evaluation

- 1) A site evaluation shall evaluate and note the
  - a) topography, landscape position of the system, vegetation, and surface drainage characteristics:
    - i) the slope gradient and aspect of each landscape element shall be determined for each potential treatment site investigated,<sup>1</sup>
    - ii) the landscape positions shall be described for each reported site investigated,
    - iii) any vegetation type that favours wet or saturated soils shall be identified using its popular name, if known, and have its location identified in relation to the proposed system,<sup>2</sup>
    - iv) any vegetation that will impact the selection of the location of the treatment system, or will require removal prior to construction of the treatment system, shall be noted, and
    - v) swales, depressions, and other drainage features that may impact system selection and design shall be located and described; and
  - b) surface waters, rock outcrops, and other natural features:
    - i) surface waters, including permanent or intermittent streams, lakes, wetlands, and other surface water within 100 m (330 ft.) of the proposed system, shall be located and described,
    - ii) rock outcrops within 50 m (165 ft.) of the *soil-based treatment system* shall be located and described,<sup>3</sup> and
    - iii) any other natural features that could impact the application and/or design of a treatment system shall be located and described.

<sup>1</sup> *Note: Sub clause (1)(a)(i) — See Appendix B-7.1.1.2.(a)(i)*

<sup>2</sup> *Note: Sub clause (1)(a)(iii) — See Appendix B-7.1.1.2.(a)(iii)*

<sup>3</sup> *Note: Sub clause (1)(b)(ii) — See Appendix B-7.1.1.2.(b)(ii)*

- 2) A sufficient number of suitably located *soil* test pits in the area selected for the *soil-based treatment system* shall be examined and *soil* profiles developed to determine the type of *sewage* treatment system that can be designed and to describe the variability of the soils on the proposed treatment site by
- a) using excavated *soil* pits and intact cores of *soil*,<sup>1</sup> and
  - b) completing an investigation to a depth that achieves the objectives of the site evaluation, and in no case shall the depth be less than 300 mm (12 in.) deeper than the *vertical separation* distance required below the proposed *soil-based treatment system*.

<sup>1</sup> Note: Clause (2)(a) — A typical method of obtaining an intact core of soil is through the use of a Shelby tube.

- 3) The characteristics of each *soil* profile investigated shall be described using Canadian System of Soil Classification nomenclature, and shall include the following in the *soil* profile description:<sup>1</sup>
- a) *soil horizons*: the distance from ground surface to the top and bottom of each *soil horizon* observed shall be measured and the distinctness and topography of the horizon boundaries described;
  - b) *soil colour*: for each *soil horizon* identified, the matrix colour and the quantity, size, contrast, and colour and any redoximorphic features present that indicate a seasonally saturated *soil* shall be described;
  - c) *texture*:
    - i) for each horizon identified, the *soil texture classification*, including any appropriate *texture* modifier, shall be reflected in the evaluation report, and
    - ii) a *soil* sample of the most *limiting condition* in the *soil* profile affecting the design shall be collected and analyzed at a laboratory using a recognized particle size analysis method to determine the *texture* of the sample;<sup>2</sup>
  - d) *structure*: for each *soil horizon* identified, the *grade of soil structure* observed and the size and class of *grade*, 0-3 shall be described;
  - e) *moist consistence*: for each *structure* observed in the profile, the *consistence* of the *soil* pedes shall be described;
  - f) *compaction*: any zones of compaction in the *soil* profile shall be described to estimate its effect on water movement, root penetration, and aeration;
  - g) *saturated zones*: for each *soil* profile described, the depth to any water or the depth to the estimated high level of seasonally saturated *soil*, based on redoximorphic or *gleyed soil* characteristics, shall be measured;
  - h) *bedrock and near-impermeable soil layers*: depth to bedrock and near-impermeable *soil* layers observed shall be measured from the ground surface; and
  - i) *restricting conditions*: for each *soil* profile described, any horizon or *soil* layer that is expected to significantly restrict downward water flow shall be identified and measured to determine its depth below ground surface.<sup>3</sup>

<sup>1</sup> Note: Sentence (3) — Refer to the *Field Book for Describing and Sampling Soils* or the *Soil Survey Manual* available on the web at: <http://sis.agr.gc.ca/cansis/intro.html> or as included in the *Alberta Private Sewage Soils Description Manual*.

<sup>2</sup> Note: Subclause (3)(c)(ii) — Where a sand fraction modifier such as coarse, medium, fine, or very fine sand is part of the *soil texture classification* description the laboratory analysis must include the determination of the sand fraction size distribution.

<sup>3</sup> Note: Clause (3)(i) — Such horizons may be discerned by evidence of episaturation above the horizon.



- 4) Investigation of surface elevations in the area of the *soil-based treatment system* shall include
  - a) identifying or establishing a permanent benchmark on the property that is shown on the plot plan of the property and provide GPS coordinates of the benchmark,
  - b) surface elevations and horizontal GPS coordinates at each *soil* profile investigation location and relative location to the benchmark, and
  - c) a topographic survey shall be performed at a scale sufficient to provide 300–600 mm (1–2 ft.) surface contours over the treatment site.
- 5) The degree of slope and slope aspect can be substituted for the topographic survey in Clause (4)(c) if the site topography is a simple planer slope.
- 6) *Property* land uses and *development* within 50 m (165 ft.) of the *on-site wastewater system*, or where a *lagoon* is used to within 100 m (330 ft.), shall be identified and described, including<sup>1</sup>
  - a) the land use of the *property* and adjacent properties; and
  - b) GPS coordinates of features such as *buildings*, *water sources*, *water wells*, *on-site wastewater systems*, roads, driveways, and other features that may impact treatment system location.

<sup>1</sup> Note: Sentence (6) — *property land uses and development within 50 m (165 ft.) of the treatment system applies to the main property itself as well as adjacent properties.*

- 7) An available area for construction of the *on-site wastewater treatment system* shall be determined considering relevant horizontal separation distances from features on the property or adjacent properties that may be required by this Standard and include<sup>1</sup>
  - a) private water sources, water wells, or municipal-licensed water supply wells;
  - b) *buildings* or other property improvements;
  - c) property boundaries;
  - d) surface waters and floodplains;
  - e) right-of-ways and easements; and
  - f) buried water supply piping, power lines, and other public or private utilities crossing the property.

<sup>1</sup> Note: Sentence (7) – See Appendix B-7.1.1.2.(7)

#### 7.1.1.3. Site Evaluation for Complex On-site Sewage Systems

- 1) The objective of a site investigation for a *development* served by an *on-site wastewater treatment system* exceeding 9 m<sup>3</sup> per day design capacity is to evaluate the<sup>1</sup>
  - a) capacity of the surficial and underlying lithology to receive and transport the added *wastewater effluent*,
  - b) near-surface groundwater conditions and the potential for *groundwater mounding*, and
  - c) assess the impact of the added *effluent* on groundwater quality and receiving surface water.<sup>1</sup>

<sup>1</sup> Note: Sentence (1) – See Appendix B-7.1.1.3.(1)

- 2) Site investigations to achieve the objectives of Sentence (1) shall include a hydrogeological investigation and a *soil* and site investigation that is consistent with the NDWRCDP document “Guidance for Evaluation of Potential Groundwater Mounding Associated with Cluster and High Density Wastewater Soil Absorption Systems, January 2005,” and which also meets the requirements of Articles 7.1.1.1 and 7.1.1.2 in addition to the following:
- a) a minimum of 3 groundwater monitoring wells, to a minimum depth of 15 m (50 ft.) and in close proximity to the *soil-based treatment area*, shall be developed to determine the groundwater depth, aquifer thickness and flow direction;
  - b) investigate and report characteristics of the developed *soil* horizons and both the underlying unsaturated and saturated lithology to a minimum depth of 15 m (50 ft.) regarding hydraulic conductivity including, for each significant change in the characteristics of the lithology, the following:<sup>1</sup>
    - i) particle-size distribution, and
    - ii) lab hydraulic conductivity testing of intact *soil* cores for vertical hydraulic conductivity;
  - c) estimate long term groundwater elevation through measurement and consideration of seasonal and long term fluctuations along with groundwater flow direction;
  - d) identify existing perched water tables, or the potential for perched *water table* formation through the depth of geologic layers investigated;
  - e) measure horizontal hydraulic conductivity in the saturated zone or zones to be used in estimating *groundwater mounding* using a slug or bail test suitable for evaluating *groundwater mounding* and contaminant transport;
  - f) identify potential groundwater discharge areas to nearby surface waters;
  - g) determine baseline *soil* chemistry characteristics of EC, SAR, pH, and Salts;
  - h) determine the water chemistry of the domestic water supply to be used for the *development* regarding SAR and EC in order to assess how the chemistry may affect the long-term hydraulic conductivity of the *soil* or impact vegetation; and
  - i) establish the baseline groundwater quality, including routine groundwater parameters, TOC, N03, NH4 TKN, total P and fecal coliform.

<sup>1</sup> Note: Clause (2)(b) – See Appendix B-7.1.1.3.(2)(b)

- 3) Notwithstanding the requirement of Clauses 2(a) and 2(b) to develop monitoring wells to a minimum of 15 m (50 ft.) or identify the *soil* lithology through to a depth of 15 m (50 ft.), in no case shall a monitoring well or investigation of the geologic lithology<sup>1</sup>
- a) extend into a confined aquifer; or
  - b) be left to remain connected to a confined aquifer, should a confined aquifer be encountered during drilling or investigation.

<sup>1</sup> Note: Sentence (3) – See Appendix B-7.1.1.3.(3).

- 4) The level and detail of the site assessment may be reduced from that set out in Sentence (2) where an initial assessment of the site characteristics and soils as set out in Chapter 2 of the document referenced in Sentence (2) indicates
- a) there is a low potential for *groundwater mounding*,
  - b) the volume of *wastewater* treated and the consequence of *groundwater mounding* is low, and
  - c) the assessment of the site and considerations of potential risk are reported and justified to the satisfaction of the approving authority.
- 5) A hydrogeological assessment to evaluate *groundwater mounding* impact on the treatment and function of the *effluent infiltration system* resulting from the *infiltration* of the added *wastewater effluent* into the *soil* shall be completed and include

- a) the evaluation of the potential for *groundwater mounding* negatively affecting the operation of the *on-site wastewater treatment system* based on the design *wastewater* flow volume of the *on-site wastewater treatment system*; and
  - b) the application of the findings of the site investigation, using an analytical or numerical model suitable for the complexity of site conditions to estimate the amount of *groundwater mounding* at the site, considering the criteria set out in the guidance document referenced in Sentence (2) or other recognized guidance documents.
- 6) Where a potential discharge of affected groundwater to a lake, river, stream, or creek located within 1 km of the *on-site wastewater system* is identified, transport and attenuation modelling shall be done to estimate the total phosphorus, nitrogen (all species), and chloride loading contributed to surface waters in the area.
- 7) The estimation of nutrient loading required by Sentence (6) shall follow the processes identified in the Water Environment Research Foundation (WERF) document “Modeling Onsite Wastewater Systems at the Watershed Scale, 2009” as it relates to the level of risk and sensitivity estimated for the receiving environment, considering the capacity of the *on-site wastewater treatment system*.<sup>1</sup>

<sup>1</sup> Note: Sentence (7) – See Appendix B-7.1.1.3.(7)

#### 7.1.1.4. Site Evaluation Report

- 1) A site evaluation report documenting the results of the site evaluation shall include the following items or any other relevant design information, and shall form part of the system design documentation:<sup>1</sup>
- a) description of the property:
    - i) address and legal. description of the property, and
    - ii) parcel identification number;
  - b) date and time of day the evaluation was performed, as well as weather conditions such as cloud cover, temperature, and precipitation;
  - c) plan of the property, to scale or dimensioned, including the following:
    - i) all property boundaries,
    - ii) *buildings*, roads, driveways, and other property improvements existing and proposed,
    - iii) existing easements,
    - iv) water wells or proposed well locations located on the property or adjacent properties within a 50 m (165 ft.) radius of the proposed system, along with the classification of whether a private or municipal well,
    - v) water wells or proposed *water well* locations within a 100 m (330 ft.) radius of a proposed on-site *system*, if a *lagoon* is to be used or a licensed municipal *water well* exists, along with the classification of whether a private or municipal well,
    - vi) topography of the proposed treatment site(s),
    - vii) surface waters, rock outcrops, and drainage features,
    - viii) *soil* pit or boring locations with surface elevations,
    - ix) location and elevation of a permanent benchmark, and
    - x) outline of available *soil-based treatment area*(s);
  - d) descriptions of each *soil* profile investigated provided in an appropriate format;
  - e) a statement regarding the treatment capability and dispersal capacity of the available site(s);
  - f) where the *soil* profile includes features that will require the lateral movement of water through the *soil* away from the dispersal system, identify constraints on the system design and allowable *effluent* hydraulic loading rates as they relate to *linear loading* rates;
  - g) a summary of the significant limiting conditions of the *soil* profile and site;

- h) a justification of the locations and number of *soil* profiles investigated;<sup>2</sup> and
- i) a description of the *development* being served, including
  - i) characteristics affecting the determination of peak and average *wastewater* flows to be used in the design,<sup>3</sup>
  - ii) the peak daily *wastewater* flow volume to be used for the *system* design, and
  - iii) anticipated influent *wastewater* strength.

<sup>1</sup> Note: Sentence (1) - See Appendix B-7.1.1.4.(1)

<sup>2</sup> Note: Clause (1)(h) - See Appendix B-7.1.1.4.(1)(h).

<sup>3</sup> Note: Clause (1)(i) - See Appendix B-7.1.1.4.(1)(i)

## **7.1.2. Site Characteristics and Evaluation Procedures — Prescriptive Requirements and Installation Standards**

### **7.1.2.1. Number of Soil Profiles Investigated**

- 1) *Soil* profiles shall be investigated at a minimum of 2 locations within or immediately adjacent to the proposed location of the *soil*-based treatment component in order to assess the hydraulic and treatment capacity of the *soil*, at least one of which is an excavated *soil* test pit, and the other location or locations may be a solid-core *soil* sample, except as allowed by Article 8.7.2.4 for open discharge systems.
- 2) As *soil* variability increases, or the area required for the system increases,
  - a) additional *soil* profiles shall be investigated, and
  - b) the number of locations needed to investigate the *soil* profile at the site shall be justified in the site evaluation report.
- 3) The GPS coordinates of the *soil* profile locations investigated shall be taken and included in the site evaluation report.

### **7.1.2.2. Depth of Soil Investigation**

- 1) The *soil* profiles shall be investigated to at least 300 mm (1 ft.) below the minimum *vertical separation* depth as per Article 8.1.1.4. needed for the proposed treatment system or to a depth of the *restricting condition* identified to show that there is sufficient suitable *soil* depth below the *soil infiltration* surface to<sup>1</sup>
  - a) provide the required *vertical separation*, and
  - b) determine the *effluent hydraulic linear loading* capacity of the *soil*.

<sup>1</sup> Note: Sentence (1) – See Appendix B-7.1.2.2.(1)

### **7.1.2.3. Percolation Test**

- 1) The results of a percolation test shall only be used in support of a design that is based on a *soil* profile investigation and site evaluation required by this standard.<sup>1</sup>

<sup>1</sup> Note: Sentence (1) – See Appendix B-7.1.2.3.(1)

### **7.1.2.4. Site Evaluation Report**

- 1) A report as required by Article 7.1.1.4. shall be developed and included in the system design information.

## Part 8 General Soil-based Treatment

### Section 8.1. Soil-based Treatment

#### 8.1.1. Soil-based Treatment — Objectives and Design Standards

##### 8.1.1.1. General

- 1) The design of any *soil-based effluent treatment system* shall meet the requirements of this Section.<sup>1</sup>

<sup>1</sup> Note: Sentence (1) – See Appendix B-8.1.1.1.

##### 8.1.1.2. Infiltration Area

- 1) In determining the *soil infiltration surface* area required for a *soil-based effluent treatment system*, the following shall be considered in the design:<sup>1</sup>
  - a) hydraulic loading capabilities of the *soil* profile;
  - b) *linear loading* rate limitations of the *soil* profile;
  - c) *organic loading* on the *soil infiltration surface* resulting from the *effluent* strength;
  - d) treatment capability of the *soil* profile;
  - e) depth of suitable *soil* required to achieve treatment objectives; and
  - f) achievement of treatment objectives at a depth that does not exceed 2.4 m (8 ft.), or a lesser depth as required by the site conditions and intended *treatment boundary limits*.

<sup>1</sup> Note: Sentence (1) – See Appendix B-8.1.1.2.(1)

##### 8.1.1.3. Effluent Loading Rates On Soil and Restrictions on Coarse Sand

- 1) The *effluent hydraulic loading rate* on the *soil infiltration surface* shall be based on the *soil texture* and *structure* as set out in Table 8.1.1.10. when the required *vertical separation* distance below the infiltrative surface is available.<sup>1,2</sup>

<sup>1</sup> Intent: Sentence (1) — The *soil texture classification* and *soil structure* are key indicators of the hydraulic conductivity of the *soil* or the rate at which the *soil* will accept and transmit water. The *soil texture classification* of samples taken from the most limiting design layer in the *soil* profile shall be determined by lab tests. Other field criteria must also be given consideration when sizing a system, such as type of clay, seasonal high water table and water quality; for example, the water's sodium adsorption ratio.

<sup>2</sup> Note: Sentence (1) - See Appendix B-8.1.1.3.(1).

- 2) *Effluent* shall not be applied where the in-situ *soil* has the *soil texture classification* of *coarse sand* unless it can be demonstrated that the *soil* profile includes horizons of other suitable textures that will result in effective treatment and protection of groundwater.<sup>1</sup>

<sup>1</sup> Note: Sentence (2) – See Appendix B-8.1.1.3.(2)

#### 8.1.1.4. Vertical Separation

- 1) *Soil-based treatment systems* shall maintain a *vertical separation* between the *soil infiltration surface* and a *restricting condition* of not less than<sup>1</sup>
  - a) 1500 mm (5 ft.) when receiving *primary treated effluent Level 1*;
  - b) 900 mm (3 ft.) when receiving *secondary treated effluent* (Level 2 or better);
  - c) 900 mm (3 ft.) below a *treatment mound* as measured from the bottom of the required minimum depth of *sand layer*; or
  - d) the depth of *soil* required to achieve a 7-day *effluent* travel time to the design boundary depth, provided the treatment boundary limit depth does not exceed 2.4 m (8 ft.), as set out in Article 8.1.1.5.

<sup>1</sup> Note: Sentence (1) – See Appendix B-8.1.1.4.(1).

- 2) If there is a very shallow *restricting condition*, prescribed material may be used if allowed and as specified in the system-type section of this standard to provide the required *vertical separation*, but in no case shall there be less than 300 mm (1 ft.) of in situ *soil* that is assigned an *effluent hydraulic loading rate* within this standard below the prescribed material and above the *restricting condition*.

#### 8.1.1.5. Loading Rates and Vertical Separation Exceptions

- 1) *Effluent hydraulic loading rates* and/or *vertical separation* distances may vary from those set out in Table 8.1.1.10. and Article 8.1.1.4., respectively, and subject to Sentence (2), if
  - a) the *effluent hydraulic loading rate* selected will result in a minimum 7-day *effluent* travel time to the *vertical separation* performance treatment boundary limit based on
    - i) the *mobile soil water content at field capacity*,
    - ii) a maximum treatment boundary limit depth that does not exceed 2.4 m (8 ft.), and
    - iii) peak design flow volumes as determined by applying the requirements of Section 2.2.;
  - b) a minimum *vertical separation* of 900 mm (3 ft.) to a *restrictive condition* maintained when the *system* is located within 2 km (1.25 miles) of a
    - i) lake,
    - ii) river,
    - iii) stream, or
    - iv) creek; and
  - c) the *effluent* is delivered to the *soil infiltration surface* using a *pressure distribution lateral pipe system* in all cases where the *vertical separation* distance is less than required in Clause 8.1.1.4.(1)(a).
- 2) *Vertical separation* distances may be reduced to a minimum of 600 mm (2 ft.) if the
  - a) *effluent* being applied will meet the qualities set out for secondary treated *effluent* Level 3-DII;
  - b) the *system* is not located within 2 km (1.25 miles) of a lake, river, stream, or creek;
  - c) the *system* is not located over GWUDI which can be classified as a domestic use aquifer; and
  - d) the objective of a 7-day *effluent* travel time is achieved.
- 3) Where the *soil* profile includes coarse fragments, the *effluent hydraulic loading rate* shall be reduced
  - a) to ensure a 7-day travel time is achieved, and
  - b) as required by Article 8.1.2.4.

**8.1.1.6. Effluent Soil Infiltration Surface Area Design**

- 1) The design of the *soil-based treatment* system shall be based on peak daily flow volumes and the *effluent* hydraulic loading rates set out in this Standard for primary and secondary treated *effluent* when the *effluent* is<sup>1</sup>
  - a) primary treated *effluent* Level 1 that at least 80% of the time has a strength of
    - i) 150 mg/L cBOD5 or less,
    - ii) 100 mg/L TSS or less, and
    - iii) 15 mg/L oil and grease or less; or
  - b) secondary treated *effluent* (Level 2, 3, or 4) that at least 80% of the time has a strength of
    - i) 25 mg/L cBOD5 or less,
    - ii) 30 mg/L TSS or less, and
    - iii) 10 mg/L oil and grease or less.

<sup>1</sup> Note: Sentence (1) – See Appendix B-8.1.1.6.(1)

- 2) When the *effluent* strength exceeds the values referred to in Sentence (1), the *effluent* hydraulic loading rate shall be reduced to achieve an *organic loading* rate on the *soil infiltration surface* that does not exceed the *organic loading* rate that would result from the anticipated *effluent* strength set out in Sentence (1).<sup>1</sup>

<sup>1</sup> Note: Sentence (2) – See Appendix B-8.1.1.6.(2)

**8.1.1.7. System Geometry and Linear Loading Rate Design**

- 1) The design and geometry of the *soil-based treatment area* shall result in an *effluent hydraulic linear loading rate* that does not exceed the *soil* profile's capability to allow the horizontal movement of the *effluent* away from the treatment system when vertical flow will be restricted and shall consider<sup>1</sup>
  - a) the values set out in Table 8.1.1.10. that relate horizontal movement of *effluent* through the *soil* to the characteristics of a *soil* profile and the slope of the landscape; or
  - b) a comprehensive and documented assessment and calculation of the *soil's* capacity to transmit the *effluent* horizontally, as set out in Article 8.1.1.9.

<sup>1</sup> Note: Sentence (1) – See Appendix B-8.1.1.7.(1)

**8.1.1.8. Pressure Distribution Required**

- 1) *Secondary treated effluent* shall be applied to any *soil-based treatment system* using a pressure *distribution lateral pipe system* that meets the requirements of Section 2.6.
- 2) A pressure *distribution lateral pipe system* that meets the requirements of Section 2.6. and having orifice spacing of not more than 900 mm (3 ft.) shall be used to apply *effluent* to soils having a *texture* of medium sandy loam or coarse sandy loam or any coarser-textured *soil*, as set out in Sentence 8.2.2.2.(1).

**8.1.1.9. Groundwater Mounding Considerations Required**

- 1) In the design of a *soil-based effluent* treatment system, the potential for *groundwater mounding* below the *soil-based effluent* treatment system shall be assessed for all systems where the<sup>1,2</sup>
  - a) available *vertical separation* distance to a restrictive *soil* layer does not exceed the required vertical separation depth by not less than 300 mm (1 ft.) except where the prescriptive requirements of Article 8.1.2.3. are applied;
  - b) daily peak flow exceeds 5.7 m<sup>3</sup> (1,250 Imp. gal.) per day, in which case the site investigation shall include an investigation of the *soil* capability and capacity to disperse water from the site, and the design documentation shall include a calculation of the potential *groundwater mounding* height to determine whether the height will negatively impact the system's treatment effectiveness; or
  - c) daily peak flow exceeds 9 m<sup>3</sup> per day, in which case the requirements of Article 7.1.1.3. shall be applied with regard to site investigation and estimation of *groundwater mounding* and nutrient loading.

<sup>1</sup> Note: Sentence (1) – Guidance on the intensity of the investigation based on related risk along with recognized methods are available from; Poeter E., J. McCray, G. Thyne, and R. Siegrist. 2005. *Guidance for Evaluation of Potential Groundwater Mounding Associated with Cluster and High-Density Wastewater Soil Absorption Systems*, January 2005.. Prepared for the National Decentralized Water Resources Capacity development Project, Project No. WU-HT-02-45, Washington University, St. Louis, MO, by the International Groundwater Modeling Center, Colorado School of Mines, Golden, CO. It can be obtained online at [www.ndwrcdp.org](http://www.ndwrcdp.org). or at National Small Flows Clearinghouse; P.O. Box 6064; Morgantown, WV 26506-6065; Tel: (800) 624-8301; WWCDRE46. Direct link to document: [http://www.ndwrcdp.org/research\\_project\\_WU-HT-02-45.asp](http://www.ndwrcdp.org/research_project_WU-HT-02-45.asp)

<sup>2</sup> Note: Sentence (1) - See Appendix B-8.1.1.9.(1)

**8.1.1.10. Effluent Loading Rates on Soil Infiltration Surface**

- 1) The *effluent* hydraulic loading rates and *effluent hydraulic linear loading* rates suitable for the *soil* profile identified at the site, as characterized by the *texture* and *structure* of the *soil*, shall be determined by using Table 8.1.1.10.
- 2) The top of a columnar structured *soil horizon* shall be considered a *restrictive condition*.<sup>1</sup>

<sup>1</sup> Note: Sentence (2) – See Appendix B-8.1.1.10.(2)

- 3) Where the *consistence* of the peds in a horizon are very firm or harder (wet *consistence*) or hard or harder (dry *consistence*), the horizon is not suitable for an *effluent hydraulic loading rate* and shall be considered a *restrictive condition*.
- 4) Prismatic structured *soil* shall be considered a *restrictive condition*, even if it is identified in Table 8.1.1.10 with an *effluent hydraulic loading rate*, if the<sup>1</sup>
  - a) *soil consistence* is very firm or harder (moist *consistence*) or hard or harder (dry *consistence*),
  - b) measured *soil* electrical conductivity is greater than 4,
  - c) *soil* sodium adsorption ratio (SAR) is greater than 8,
  - d) *soil* coefficient of linear extensibility (COLE) is greater than 3%, or
  - e) *soil* dispersion test shows more than slight dispersion of the *soil*.

<sup>1</sup> Note: Sentence (1) – See Appendix B-8.1.1.10.(4)



Table 8.1.1.10. (Metric) effluent Soil Loading Rates and linear loading Rates													
Soil Characteristics			Effluent loading L/day/sq. metre		Hydraulic linear loading Rate, L/day/m								
					Slope of land								
					0 - 4%			>4 - 9%			>9%		
Texture	Structure		Effluent Quality		Infiltration distance <sup>1</sup> , m			Infiltration distance <sup>1</sup> , m			Infiltration distance <sup>1</sup> , m		
	Shape	grade	30-150mg/L	<30mg/L	0.3 <0.6	0.6 <1.2	1.2<1.5	0.3 <0.6	0.6 <1.2	1.2<1.5	0.3 <0.6	0.6 <1.2	1.2<1.5
COS2, MS, LCOS, LMS Requires pressure distribution	--	OSG	14.7	14.7	74.6	89.5	104.4	89.5	104.4	119.3	104.4	119.3	134.2
	--	OSG	19.6	24.5	67.1	82	96.9	74.6	89.5	104.4	89.5	104.4	119.3
COSL, MSL Requires pressure distribution	--	OM	9.8	29.4	52.2	59.7	67.1	61.2	68.6	76.1	89.5	104.4	119.3
	PL	1	9.8	24.5	52.2	59.7	67.1	61.2	68.6	76.1	74.6	89.5	104.4
		2,3	0	9.8	37.3	44.7	52.2	40.3	47.7	55.2	43.3	50.7	58.2
	PR/BK/ GR	1	19.6	29.4	67.1	82	96.9	74.6	89.5	104.4	89.5	104.4	119.3
		2,3	29.4	29.4	67.1	82	89.5	74.6	89.5	104.4	89.5	104.4	119.3
FSL, VFSL	--	OM	8.8	17.6	34.3	38.8	43.2	40.3	44.7	49.2	47.7	55.2	62.6
	PL	1	8.8	17.6	34.3	38.8	43.2	40.3	44.7	49.2	47.7	55.2	62.6
		2,3	0	7.3	37.3	44.7	52.2	40.3	47.7	55.2	43.3	50.7	58.2
	PR/BK/ GR	1	8.8	22	52.2	59.7	67.1	56.7	64.1	71.6	61.2	68.6	76.1
		2,3	15.7	30.8	56.7	64.1	71.6	61.2	68.6	76.1	65.6	73.1	80.5
L	--	OM	8.8	22	34.3	38.8	43.2	40.3	47.7	49.2	43.3	50.7	62.6
	PL	1	14.7	22	52.2	59.7	67.1	56.7	64.1	71.6	61.2	68.6	76.1
		2,3	0	7.3	37.3	44.7	52.2	40.3	47.7	55.2	43.3	50.7	58.2
	PR/BK/ GR	1	14.7	22	52.2	59.7	67.1	56.7	64.1	71.6	61.2	68.6	76.1
		2,3	22	30.8	56.7	64.1	71.6	61.2	68.6	76.1	65.6	73.1	80.5
SIL	--	OM	0	8.8	37.3	44.7	52.2	40.3	47.7	55.2	43.3	50.7	58.2
	PL	1	0	7.3	37.3	44.7	52.2	40.3	47.7	55.2	43.3	50.7	58.2
		2,3	0	0	--	--	--	--	--	--	--	--	--
	PR/BK/ GR	1	14.7	22	40.3	44.7	49.2	44.7	49.2	53.7	52.2	59.7	67.1
		2,3	22	30.8	47.7	55.2	62.6	52.2	59.7	67.1	56.7	64.1	71.6
SCL, CL, SICL, SI	--	OM	0	0	--	--	--	--	--	--	--	--	--
	PL	1	0	7.3	25.4	32.8	40.3	28.3	35.8	43.2	31.3	38.8	46.2
		2,3	0	0	--	--	--	--	--	--	--	--	--
	PR/BK/ GR	1	8.8	13.2	37.3	44.7	52.2	40.3	47.7	55.2	43.3	50.7	58.2
		2,3	13.2	22	43.3	50.7	58.2	47.7	55.2	62.6	52.2	59.7	67.1
SC, C, SIC	--	OM	0	0	--	--	--	--	--	--	--	--	--
	PL	1,2,3	0	0	--	--	--	--	--	--	--	--	--
		1	0	0	--	--	--	--	--	--	--	--	--
PR/BK/ GR	2,3	6.9	9.8	37.3	44.7	52.2	40.3	47.7	55.2	43.3	50.7	58.2	
	HC	--	OM	0	0	--	--	--	--	--	--	--	--
PL		1,2,3	0	0	--	--	--	--	--	--	--	--	
		1	0	0	--	--	--	--	--	--	--	--	
PR/BK/ GR	2,3	4.4	7.8	31.3	38.8	46.2	34.3	41.8	49.2	37.3	44.7	52.2	

Soil Texture and Structure Abbreviations				
<b>COS</b> Coarse Sand		<b>LVFS</b> Loamy Very Fine Sand		<b>SI</b> Silt
<b>MS</b> Medium Sand		<b>COSL</b> Coarse Sandy Loam		<b>SCL</b> Sandy Clay Loam
<b>LCOS</b> Loamy Coarse Sand		<b>MSL</b> Medium Sandy Loam		<b>CL</b> Clay Loam
<b>LMS</b> Loamy Medium Sand		<b>FSL</b> Fine Sandy Loam		<b>SICL</b> Silty Clay Loam
<b>FS</b> Fine Sand		<b>VFSL</b> Very Fine Sandy Loam		<b>SC</b> Sandy Clay
<b>LFS</b> Loamy Fine Sand		<b>L</b> Loam		<b>SIC</b> Silty Clay
<b>VFS</b> Very Fine Sand		<b>SIL</b> Silt Loam		<b>C</b> Clay
<b>HC</b> Heavy Clay				
<b>PL</b> Platy	<b>PR</b> Prismatic	<b>BK</b> Blocky	<b>GR</b> Granular	<b>M</b> Massive SG Single Grain
<b>0</b> Structureless	<b>1</b> Weak	<b>2</b> Moderate	<b>3</b> Strong	

<sup>1</sup> Note: infiltration distance is the depth of suitable soil below the in situ soil infiltration surface the effluent is applied to and the restrictive condition.

Table 8.1.1.10 infiltration rates in L/d/m<sup>2</sup> for wastewater effluent strength of >30 mg/L BOD5 or wastewater effluent strength of <30 mg/L BOD5 and hydraulic linear loading rates in L/d/m of system length based on the soil characteristics of texture and structure and the site conditions of slope and infiltration depth to restrictive soil layers. Values assume daily wastewater volume estimates used in the design are based on the values set out in Subsection 2.2.2. or include the same safety factor. If horizon consistence is stronger than firm or any cemented class or the clay mineralogy is smectitic, the horizon is limiting regardless of other soil characteristics {adapted from 2000, E. Jerry Tyler}.

<sup>2</sup> Note: The application of effluent to Coarse Sand textured soil is not allowed except where the requirements of Sentence 8.1.1.3.(2) are met.

<sup>3</sup> See restriction on prismatic soils set out in Sentence 8.1.1.10.(4)

Figure 8.1.1.10. Soil texture classification Triangle

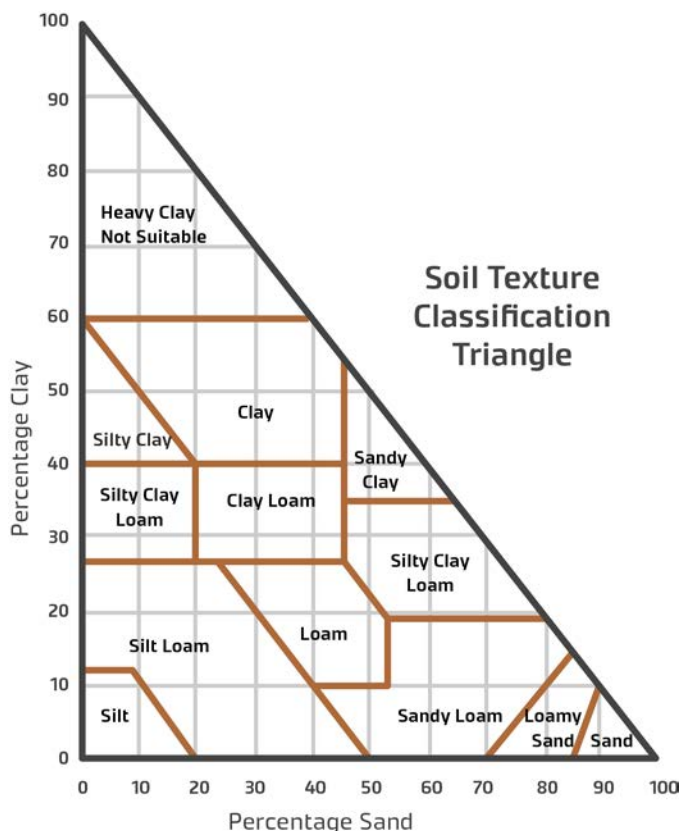

Note: Plotting the percentage of sand and clay provides the remaining percentage of silt.

**8.1.1.11. Supplementary Air Supply to Soil-based Effluent Treatment Systems**

- 1) A positive pressure air supply for the purpose of promoting aerobic conditions may be provided to *treatment field* trenches, treatment mounds, or sand filters, provided the<sup>1,2</sup>
  - a) *effluent* hydraulic load on the *system* does not exceed the loading rates allowed by this standard on the *soil* profile at the site and for the *effluent* quality applied,
  - b) requirements of 7-day travel time through the *vadose zone* is not compromised,
  - c) *effluent* is distributed by pressure distribution lateral pipes, and
  - d) *system* is designed in such a way that it will not cause *effluent* to be pushed back into the *effluent* chamber when air is introduced.

<sup>1</sup> Note: If the supply of air for the sewage system is taken from inside a building, the designer must ensure that the removal of air from the building will not create an unsafe depressurization of the building that may affect fuel burning appliances or cause problems with the building ventilation system.

<sup>2</sup> Note: Sentence (1) - See Appendix B-8.1.1.11.

**8.1.2. Soil-based Treatment — Prescriptive Requirements and Installation Standards****8.1.2.1. Evaluation**

- 1) For the design of in situ *soil-based treatment systems*, the *soil* at the location of the system and required surrounding area shall be evaluated in accordance with Part 7 to identify the *soil* characteristics and conditions needed to determine the<sup>1</sup>
  - a) appropriate *soil infiltration surface effluent hydraulic loading rate*, and
  - b) depth to seasonally saturated *soil* conditions or restrictive conditions that
    - i) limit available *vertical separation* and
    - ii) are needed to select acceptable *linear loading* rates for the system design.

<sup>1</sup> Note: Sentence (1) – See Appendix B-8.1.2.1.(1)

**8.1.2.2. Infiltration Loading Rate**

- 1) The *soil infiltration surface* loading rate shall not exceed the amount set out in Table 8.1.1.10. based on the *soil* characteristics identified by the site evaluation.
- 2) Except where determined in accordance with the requirements of Article 8.1.1.5., the *effluent hydraulic loading rate* applied to a *soil infiltration surface* shall not exceed<sup>1</sup>
  - a) 14.7 litres per sq. metre (0.3 Imp. gal. per sq. ft.) per day on *coarse sand, medium sand, loamy coarse sand, or loamy medium sand textured soils*;
  - b) 29.4 litres per sq. metre (0.6 Imp. gal. per sq. ft.) per day on *fine sand, very fine sand, loamy fine sand, loamy very fine sand, coarse sandy loam, or medium sandy loam textured soils*; and
  - c) 40.7 litres per sq. metre (0.83 Imp. gal. per sq. foot) per day on *fine sandy loam* and *very fine sandy loam to clay-textured soils*.

<sup>1</sup> Note: Sentence (2) – See Appendix B-8.1.2.2.(2)

- 3) *Effluent* shall not be applied to soils having a *texture* of coarse sand except where conditions allow such a design in compliance with Sentence 8.1.1.3.(2).

**8.1.2.3. Linear Loading Rates Not Exceeded**

- 1) Except as provided for in Article 8.1.1.7., the geometry of the *soil infiltration surface* shall be designed to ensure the *linear loading* rates set out in Table 8.1.1.10. are not exceeded.<sup>1</sup>

<sup>1</sup> Note: Sentence (1) – See Appendix B-8.1.2.3.(1)

**8.1.2.4. Infiltration Loading Rate Reduced, Coarse Fragments**

- 1) The *effluent hydraulic loading rate* on soils that have a *soil texture classification* of coarse sand, medium sand, loamy coarse sand, or loamy medium sand, that also have a *coarse-fragment* content by volume that exceeds<sup>1, 2</sup>
- a) 35% but is less than or equal to 60%, shall be reduced to 9.8 litres per sq. metre (0.2 Imp. gal. per sq. ft.) per day for both primary and secondary treated *effluent*;
  - b) 60% but is less than or equal to 75%, shall be reduced to 7.4 litres per sq. metre (0.15 Imp. gal. per sq. ft.) per day for both primary and secondary treated *effluent*; or
  - c) 75%, shall be reduced to 0.0 litres per sq. metre (0.0 Imp. gal. per sq. ft.) per day.

<sup>1</sup> Note: Increasing volumes of coarse fragments in the soil limit the amount of soil particle surface area in the soil that is needed to achieve treatment. The water holding capacity of these soils is also limited so it becomes difficult to achieve the required 7 day travel time to the treatment boundary. As coarse fragment content increases, the effluent loading rate must be reduced to achieve the treatment objectives of the Standard.

<sup>2</sup> Note: Sentence (1) - See Appendix B-8.2.1.4.

## Section 8.2. Treatment Fields

### 8.2.1. Treatment Fields — Objectives and Design Standards

#### 8.2.1.1. General

- 1) A *treatment field* shall meet the following objectives:
  - a) provide temporary storage of the *effluent* until it is able to infiltrate into the *soil*,
  - b) break down the *organic loading* contained in the *effluent*,
  - c) provide an area of *soil* over which the *effluent* is spread to reduce the hydraulic and *organic loading* on each part of the *soil infiltration surface*,
  - d) spread the *effluent* over a suitably sized area to enable sufficient oxygen to be transferred through the *soil* in order to achieve treatment objectives and long-term utilization, and
  - e) introduce the *effluent* into the *soil* and be constructed in a manner that minimizes the risk of *effluent* breakout through the material covering the *soil infiltration surface* area that provides a barrier against direct contact with the *effluent*.
- 2) The design of a *treatment field* shall meet all requirements set out in Section 8.1.

#### 8.2.1.2. Effluent Treatment Quality in Soil

- 1) A *treatment field* shall treat the applied *effluent* as it migrates through the *soil*, as measured at the *vertical separation* boundary required for the design and *effluent* quality being applied, to the following quality:
  - a) fecal coliform < 10 cfu/100 mL above background levels, or
  - b) fecal coliform < 2 MPN/gram of dry *soil* above background levels.

#### 8.2.1.3. Effluent Loading Rates

- 1) The *effluent hydraulic loading rates* for sub-surface treatment fields are set out in Article 8.1.1.10. and are based on *effluent* qualities that are equal to or better than primary treated *effluent* Level 1 or secondary treated *effluent*.<sup>1</sup>

<sup>1</sup> Note: Sentence (1) – See Appendix B-8.2.1.3.(1).

- 2) If the strength of the *effluent*
  - a) is higher than secondary treated *effluent*, the *effluent* hydraulic loading rates shall be based on primary treated *effluent* Level 1; or
  - b) is higher than primary treated *effluent* Level 1, the *effluent hydraulic loading rate* shall be reduced as required to result in a mass *organic loading* rate on the *soil infiltration surface* that does not exceed the calculated *organic loading* resulting from the application of *effluent* that meets the primary treatment standard.

#### 8.2.1.4. Gravity Distribution

- 1) A *treatment field* utilizing gravity distribution over the *soil infiltration surface* shall receive a dose volume that
  - a) encourages spreading over the entire *soil infiltration surface*, and
  - b) is within the range of 3.4 and 12 L per square metre (0.07 to 0.25 Imp. gal. per sq. ft.) of weeping lateral trench per dose.

#### 8.2.1.5. Depth of Weeping Lateral Trench

- 1) The depth to the *weeping lateral trench* bottom shall be as shallow as possible, while considering the need for frost protection, in order to maximize the transfer of oxygen through the *soil* at the site to the *soil infiltration surface* and *vadose zone* below the trench bottom.

#### 8.2.1.6. Trench Width and Separation

- 1) The width of a trench used in a system design shall consider the *organic loading* on the *soil infiltration surface* and the ability of the *soil* to transmit the required oxygen demand to the trench bottom and *vadose zone*.<sup>1</sup>

<sup>1</sup> Note: Sentence (1) – See Appendix B-8.2.1.6.(1)

- 2) Adequate separation between trenches shall be provided to enable sufficient re-aeration of the subsurface *soil* receiving *effluent*.

#### 8.2.1.7. Effluent Loading Rate on Trench Bottom

- 1) The design *effluent hydraulic loading rate* on the trench bottom area of a *treatment field* shall be based on Table 8.1.1.10. and comply with Article 8.1.2.2.

#### 8.2.1.8. Pressure Distribution Reduction in Trench Bottom Area

- 1) The *effluent hydraulic loading rate* may be increased by a factor of:
  - a) 1.2 on a conventional *treatment field* or *gravel substitute treatment field*, supplied with *primary treated effluent Level 1* when *pressure distribution lateral piping* is used in accordance with Section 2.6., but in no case shall the resulting *effluent hydraulic loading rate* exceed the *effluent hydraulic loading rate* for *secondary treated effluent* on that same *soil* profile or limited elsewhere in this standard.<sup>1</sup>
  - b) 1.0 on a conventional *treatment field* or *gravel substitute treatment field*, supplied with *secondary treated effluent* when using *pressure distribution lateral piping*.
  - c) 1.1 on a conventional *treatment field* or *gravel substitute treatment field*, supplied with *secondary treated effluent* when using *pressure distribution lateral piping* and timed dosing.

<sup>1</sup> Note: Sentence (1) – Notwithstanding the provisions of this Article, limits on loading rates also need to consider *effluent hydraulic loading rate* limits established for coarse textured soils and/or coarse fragment content as set out in other articles to ensure a minimum 7-day travel time to the treatment boundary is achieved.

#### 8.2.1.9. Serial Distribution Prohibited

- 1) A *treatment field* shall not use *serial distribution* as a method to distribute *effluent* to weeping lateral trenches.<sup>1</sup>

<sup>1</sup> Intent: Sentence (1) — The *effluent* should be distributed to each *weeping lateral trench* evenly. The *effluent* should not be allowed to flow through 1 *weeping lateral trench* to reach another at a lower elevation.

#### 8.2.1.10. Equal Distribution to Gravity Weeping Laterals

- 1) When gravity distribution is used to supply *effluent* to the treatment-field *weeping lateral trenches*, the *effluent* distribution system shall be designed to provide approximately equal *effluent* distribution to each *weeping lateral trench*.

**8.2.1.11. Monitoring Effluent Ponding Depth**

- 1) To facilitate monitoring of the *soil-based treatment system*, each *weeping lateral trench* shall be equipped with a method of evaluating the ponding depth within the length of the *weeping lateral trenches*.<sup>1</sup>

<sup>1</sup> Note: Sentence (1) – See Appendix B-8.2.1.11.(1).

**8.2.1.12. Treatment Field Layout**

- 1) The geometry of the *treatment field* layout shall consider the *linear loading* rates set out in this Standard, or shall be determined by calculation of *groundwater mounding* impacts to ensure that the cumulative loading from numerous trenches does not exceed the capacity of the *soil* to transmit the *effluent* away from the weeping lateral trenches.

**8.2.1.13. Fine Textured Soil Restriction**

- 1) A *treatment field* shall not be installed on soils that have an *effluent hydraulic loading rate* of less than 9.80 L per square metre (0.2 Imp. gal. per sq. ft.) per day.

**8.2.2. Treatment Fields — Prescriptive Requirements and Installation Standards****8.2.2.1. Separation Distances**

- 1) A *treatment field*, measured from any part of a *weeping lateral trench*, shall not be located within
  - a) 15 m (50 ft.) of a *water source* or *water well*;
  - b) 100 m (330 ft.) of a licensed municipal *water well*;
  - c) 15 m (50 ft.) of a *water course*, except as provided in Article 2.1.2.4;
  - d) 1.5 m (5 ft.) of a *property line*;
  - e) 10 m (33 ft.) of a basement, cellar, or crawl space;<sup>1</sup>
  - f) 1 m (3.25 ft.) of a *building* that does not have a permanent foundation;
  - g) 5 m (17 ft.) of a *building* that has a permanent foundation but does not have a basement, cellar, or crawl space; and
  - h) 5 m (17 ft.) from a *septic tank* or *packaged sewage treatment plant*.

<sup>1</sup> Note: Clause (1)(d) — The 10 m (33 ft.) requirement to a basement, cellar, or crawl space is intended to protect excavations below grade from accumulating migrating effluent. A crawl space that is not below grade, or where the level of the ground surface at the soil-based treatment area is below the level of the crawl space, the separation required is 5 m (17 ft.) clearance, as it can be treated as a building without a basement.

### 8.2.2.2. Coarse-Textured Soil - Restrictions On Effluent Application

- 1) Except as allowed by Sentence (2), a pressure *effluent distribution lateral pipe system* having orifices spaced at not more than 900 mm (3 ft.), and meeting the requirements of Section 2.6., shall be used to distribute the *effluent* over the *soil infiltration surface* of a *treatment field* when the *texture* of the *soil* at and below the *effluent* infiltrative surface has a *soil texture* of
  - a) *coarse sand*,
  - b) *medium sand*,
  - c) *loamy coarse sand*,
  - d) *loamy medium sand*,
  - e) *fine sand*,
  - f) *very fine sand*,
  - g) *loamy fine sand*,
  - h) *loamy very fine sand*,
  - i) *coarse sandy loam*, or
  - j) *medium sandy loam*.
  
- 2) Notwithstanding Sentence (1), gravity distribution of the *effluent* is allowed if, within the allowed depth to the treatment boundary limit, there is an *in situ soil horizon*
  - a) having a *soil texture* of very fine or *fine sandy loam* or finer textured *soil* with a minimum thickness of not less than 900 mm (3 ft.), and
  - b) the finer-textured *soil horizon* described in Clause (a) extends over the entire area of the *treatment field*.<sup>1</sup>

<sup>1</sup> Note: Sentence 2) — The trenches cannot be lined with imported material to take the place of the *in situ soil*.

### 8.2.2.3. Weeping Lateral Trench Construction

- 1) A *weeping lateral trench* shall
  - a) be not more than 900 mm (3 ft.) deep;<sup>1</sup>
  - b) be between 300 mm (12 in.) and 900 mm (3 ft.) wide;
  - c) have a *nominally level* bottom;
  - d) include a void space created by
    - i) a chamber,
    - ii) *weeping lateral trench* media meeting the requirements of Sentence 8.2.3.1.(1) placed at the bottom of the trench filling the entire width of the trench to a depth of 300 mm (1 ft.), or
    - iii) sand meeting the requirements of Sentence 8.2.3.1.(2) placed in the bottom 150 mm (6 in.) of the trench, covered by 150 mm (6 in.) of *weeping lateral trench* media;
  - e) provide a minimum of 30% void volume under compression conditions equal to the weight of 1 m (3.25 ft.) of earth cover; and
  - f) be covered with a material that will prevent migration of *soil* particles into the void space of the distribution media and allow the movement of air into the system that is either
    - i) a *geotextile fabric* that allows the movement of air and water through it,
    - ii) 75 mm (3 in.) of a non-oil-seed straw, or other equivalent fibrous material, or
    - iii) a material having equivalent properties.

<sup>1</sup> Note: Clause (1)(a) — While no minimum depth is specified in this Standard, a cover of 300 mm (12 in.) of soil over the top of the gravel and effluent pipe has typically been maintained, although there are many examples of weeping lateral trenches being placed at shallower depth throughout Alberta without encountering freezing problems. The burial depth required for adequate frost protection depends on a number of factors which include typical snow cover, type of soil at the site, and length of time the system may go without receiving effluent that adds heat to the soil.



- 2) A *weeping lateral trench* shall be located so as to provide a minimum of 900 mm (3 ft.) of earth between the side wall of the trench and the sidewall of an adjacent *weeping lateral trench*.

#### 8.2.2.4. Gravity Distribution Weeping Lateral Pipe

- 1) A gravity distribution *weeping lateral pipe* shall be
- a) laid *nominally level* at a maximum depth of 600 mm (2 ft.) below the finished ground surface, as measured from the top of the pipe; and
  - b) installed with the top of the pipe at the top of the *drain media* used in the trench.

#### 8.2.2.5. Weeping Lateral Connected to Gravity Distribution Header

- 1) Where weeping lateral pipes connect to a gravity *distribution header* or *field header*, all piping in the *treatment field* shall be installed at the same elevation.<sup>1</sup>

<sup>1</sup> Note: Sentence (1) – See Appendix B-8.2.2.5.(1) -

#### 8.2.2.6. Gravity Weeping Laterals at Different Elevations

- 1) Where weeping lateral pipes in the field are at different elevations either<sup>1</sup>
- a) pressure distribution supply to each *weeping lateral trench* shall be used, or
  - b) a distribution box shall be used to distribute the *effluent* evenly to each *weeping lateral pipe*.

<sup>1</sup> Note: Sentence (1) – See Appendix B-8.2.2.6.(1)

#### 8.2.2.7. Distribution Box

- 1) When used in a system, a distribution box shall<sup>1,2</sup>
- a) have an internal dimension not exceeding 300 mm (12 in.),
  - b) provide relatively equal distribution to all outlets, and
  - c) be readily accessible for inspection and service and adequately protected from frost.

<sup>1</sup> Intent: Sentence (1) — To ensure relatively equal distribution to all weeping laterals. The maximum internal dimension of the distribution box minimizes the impact that either soil movement, or frost heaving that tips the box out of level, will have on the even distribution of the effluent. Accessibility is required to confirm distribution during service.

<sup>2</sup> Note: Sentence (1) - 8.2.2.7.(1)

#### 8.2.2.8. Drop Boxes

- 1) Notwithstanding Sentence 8.2.1.10.(1), where drop boxes are used to distribute *effluent* to weeping lateral trenches the<sup>1</sup>
- a) *treatment field* may be installed on sloping ground;
  - b) invert of the outlet piping to the next drop box shall be
    - i) above the top of the *weeping lateral pipe* outlet, and
    - ii) a minimum of 25 mm (1 in.) below the invert of the inlet piping to the drop box; and
  - c) drop box serving each *weeping lateral pipe* shall have provisions for preventing *effluent* from entering the *weeping lateral pipe* to facilitate resting of the lateral.

<sup>1</sup> Intent: Sentence (1) — A drop box system is a form of an anaerobic effluent treatment system. It is intended to be used primarily in very porous soil structures where the creation of a restricting layer of biomat is desired. This biomat reduces the infiltration rate of effluent into the soil. This design is used to reduce infiltration rates where desired. A drop box cannot be used as a “distribution box” for distributing effluent evenly to weeping lateral trenches.

- 2) Where drop boxes are used, the operation manual shall specifically identify the requirement to periodically redirect *effluent* flow.

**8.2.2.9. Location Restriction**

- 1) A *treatment field* shall not be located under
  - a) a roadway or driveway,
  - b) a paved area,
  - c) a vehicle parking lot,
  - d) any *structure*, or
  - e) a vegetable garden.

**8.2.2.10. Monitoring Ports**

- 1) A minimum 100 mm (4 in.) monitoring port, fitted with a mechanically fastened top, extending from the surface of the ground to the depth of the *soil infiltration surface*, shall be provided within 4.5 m (15 ft.) from each end of a *weeping lateral trench*.

**8.2.2.11. Raised Treatment Field Contact with In Situ Soil**

- 1) Where the bottom of the trench forming the *soil infiltration surface* is within the surface vegetation thatch zone or above the elevation of the in situ *soil*,
  - a) the *soil* interface at the in situ surface directly below the trench bottom shall be broken up, or the thatch removed, to develop strong contact between the fill material of the trench and the in situ *soil*;
  - b) the fill material that is directly under the trench bottom, from the in situ *soil* surface to the finished elevation of the *soil infiltration surface* area, shall meet the requirements of the sand specified in Article 8.4.3.1.; and
  - c) *effluent* shall be distributed through the laterals using a pressure *distribution lateral pipe system* meeting the requirements of Section 2.6.
- 2) A raised *treatment field* shall not be used unless there is a minimum of 600 mm (2 ft.) of in situ *soil* that is assigned an *effluent hydraulic loading rate* in Table 8.1.1.10. below the raised *treatment field*.

**8.2.2.12. Raised Treatment Field Fill Material**

- 1) *Coarse sand, medium sand, fine sand, loamy medium sand or loamy coarse sand* fill material shall be used for the backfill material covering the area of the raised *treatment field*, and it shall be<sup>1,2</sup>
  - a) placed over the *gravel* layer of the trenches or over the chambers to a depth of 300 mm (1 ft.) to 600 mm (2 ft.), and
  - b) the finished grading of the fill material shall ensure positive drainage of precipitation off the area of the raised *treatment field*.

<sup>1</sup> Intent: Sentence (1) — To provide an adequate slope (1% or more) on the top of the field to prevent excessive infiltration and ponding of precipitation and snow melt on the area of the field.

<sup>2</sup> Note: Sentence (1) - See Appendix B-8.2.2.12.(1)

- 2) In addition to the requirements of Sentence (1), 75 mm (3 in.) of *soil* having a *texture* not finer than *sandy loam* and not coarser than *loamy fine sand* shall be placed over the fill material to cover the entire area of the raised *treatment field* in order to support a grass vegetative cover.<sup>1</sup>

<sup>1</sup> Note: Sentence (2) – See Appendix B-8.2.2.12.(2)

**8.2.2.13. Grass Cover on Raised Treatment Field**

- 1) A grass cover shall be established over the entire area of the raised *treatment field*.<sup>1</sup>

<sup>1</sup> *Intent: Sentence (1) — A contractor meets the requirement of this Sentence by seeding the area to grass, leaving the responsibility to the owner to water and maintain the grass cover. The grass cover is needed to prevent erosion of the area and limit infiltration under heavy precipitation events.*

**8.2.2.14. Side Slopes of Raised Treatment Field Area**

- 1) The side slopes on the area covering the raised *treatment field* shall not be steeper than 1:3 (one vertical to 3 horizontal).

**8.2.3. Treatment Fields — Requirements for Materials****8.2.3.1. Weeping Lateral Trench Media**

- 1) Except as provided in Sentence (3), the *drain media* used in a *weeping lateral trench* shall
  - a) consist of clean washed *gravel*, clean crushed rock, or other equivalent media that will maintain structural integrity and not be degraded by the environment created in the *treatment field* trench;<sup>1</sup>
  - b) have a particle-size distribution by weight of
    - i) 100 percent passing the 50 mm (2 in.) sieve,
    - ii) 0 to 25 percent passing the 12.5 mm (½ in.) sieve,
    - iii) 0 to 10 percent passing the 9.51 mm (3/8 in.), sieve,
    - iv) 0 to 2 percent passing the 1.18 mm (3/64 in.), No. 16 sieve, and
    - v) 0 to 1 percent passing the 0.15 mm (0.0059 in.) No. 100 sieve, and;
  - c) be able to withstand vertical and horizontal loads from backfill equal to a minimum of 1 m (3.25 ft.) of earth cover.

<sup>1</sup> *Note: Clause (1)(a) — See Appendix B-8.2.3.1.*

- 2) Sand used for the sand layer allowed in a *treatment field* trench shall have
  - a) a particle-size distribution that meets
    - i) the concrete sand specification provided in CAN/CSA-A23.1, “Concrete Materials and Methods of Concrete Construction,”
    - ii) the concrete sand specification provided in ASTM-C33, “Standard Specification for Concrete Aggregates,” or
    - iii) the particle-size distribution required for a medium-sand sand filter as set out in Sentence 5.3.3.4.(2); and
  - b) no more than 1 percent of a particle size passing through a 0.15 mm (0.0059 in.), No. 100 sieve.
- 3) When shredded tires are used as *weeping lateral trench* media, they shall be individual pieces
  - a) between 25 mm (1 in.) and 50 mm (2 in.) in size, and
  - b) washed free of particles, *fines*, and dust.

**8.2.3.2. Piping**

- 1) Piping used in a *treatment field* shall meet the requirements of Section 2.5.

## Section 8.3. Chamber System Treatment Fields

### 8.3.1. Chamber System Treatment Fields — Objectives and Design Standards

#### 8.3.1.1. General

- 1) The objectives set out in Subsection 8.2.1. apply to chamber system treatment fields.
- 2) The design of chamber system treatment fields shall meet requirements set out in this Standard except as provided in this Section.

#### 8.3.1.2. Serial Distribution Prohibited

- 1) *Serial distribution* shall not be used as the method of distributing *effluent* to weeping lateral trenches that use chambers.<sup>1</sup>

<sup>1</sup> Note: Sentence (1) – See Appendix B-8.3.1.2.(1).

#### 8.3.1.3. Chamber Dimensions

- 1) Chambers shall be a minimum of 300 mm (1 ft.) wide and a maximum of 900 mm (3 ft.) wide.

#### 8.3.1.4. Calculation of Infiltration Area

- 1) The effective *soil infiltration surface* area provided by chambers shall be calculated using the exterior width at the base of the chamber.<sup>1</sup>

<sup>1</sup> Note: Sentence (1) – See Appendix B-8.3.1.4.(1)

#### 8.3.1.5. Calculation of Trench Bottom Area

- 1) Notwithstanding Article 8.2.1.7., and as limited by Article 8.3.1.6, the *effluent hydraulic loading rates* for a *treatment field* using chambers may be increased by a factor of
  - a) 1.1 when *primary treated effluent* Level 1 is distributed in the trench by gravity,
  - b) 1.3 when the *primary treated effluent* Level 1 is distributed using *pressure distribution* lateral piping and no reduction in area has been calculated for the use of *pressure distribution* lateral piping as provided in Article 8.2.1.8.; and
  - c) 1.1 when *secondary treated effluent* is distributed using *pressure distribution*, or
  - d) 1.2 when *secondary treated effluent* is distributed using *pressure distribution* and timed dosing.

#### 8.3.1.6. Loading Rate Not to Exceed 7 Day Travel Time Limits

- 1) The *effluent hydraulic loading rate* on the actual open area provided by the chambers shall not exceed the *effluent hydraulic loading rates* set out in Articles 8.1.1.2., 8.1.1.3., and 8.1.1.5., or that would result in the travel time of *effluent* to the *treatment boundary limit* to be less than 7 days, as limited by Clause 8.1.1.4.(1)(d).

### **8.3.2. Chamber System Treatment Fields — Prescriptive Requirements and Installation Standards**

#### **8.3.2.1. Separation Distances**

- 1) The location of a sub-surface chamber system shall comply with the requirements of Article 8.2.2.1. that sets out the minimum separation distances for treatment fields.

#### **8.3.2.2. Manufacturer's Instructions**

- 1) Chamber systems shall be installed in accordance with the manufacturer's instructions, except that in the event of a conflict with this Standard, the requirements of this Standard shall apply.

#### **8.3.2.3. Prevention of Soil Disturbance and Erosion**

- 1) Chamber system installations that do not include *effluent* distribution piping running the total length of the trench shall include a means to dissipate the hydraulic energy of the *effluent* delivered to the trench in order to minimize the disturbance and erosion of *soil* at the trench bottom where the *effluent* is delivered by using<sup>1,2</sup>
  - a) *geotextile fabric* covering the width of the trench under the chamber in the most upstream 1.5 m (5 ft.) portion of the *weeping lateral trench* or other area that receives *effluent*,
  - b) a minimum of 50 mm (2 in.) of *gravel* in the most upstream 1.5 m (5 ft.) portion of all weeping lateral trenches or any other area that receives *effluent*, or
  - c) other suitable means to dissipate the hydraulic energy of the *effluent* it is receiving and prevent erosion or disturbance of the trench bottom.

<sup>1</sup> Intent: Sentence (1) — To prevent erosion or disturbance of the trench bottom by the *effluent* that spills into the chamber rather than being piped the entire length of the chamber lateral.

<sup>2</sup> Note: Sentence (1) - See Appendix B-8.3.2.3.(1)

### **8.3.3. Chamber System Treatment Fields — Requirements for Materials**

#### **8.3.3.1. Certification**

- 1) Infiltration chambers shall be *certified* as meeting IAPMO PS 63-2019 Plastic Leaching Chambers as amended or replaced from time to time.
- 2) All chambers shall be *certified* as meeting or exceeding the requirements of the American Association of State Highway and Transportation Officials H -10 or H -20 ratings as referenced in the IAPMO PS 63-2019 standard.

## Section 8.4. Treatment Mounds

### 8.4.1. Treatment Mounds — Objectives and Design Standards

#### 8.4.1.1. General

- 1) The design and installation of a *treatment mound* has the following objectives:
  - a) breaking down the *organic loading* contained in the *sewage effluent*,
  - b) enabling the transfer of an adequate supply of oxygen into the sand layer through the disturbed *soil* used to construct the *berm* covering the sand layer of the *treatment mound*,
  - c) providing an area of *soil* over which the *effluent* is spread to reduce the hydraulic and *organic loading* on each part of the *soil infiltration surface*,
  - d) utilizing the upper biological layers of the *soil* and maximize the available *vertical separation* distance to underlying restrictive conditions in the *soil* by constructing the *mound* on top of the in situ *soil*, and
  - e) to introducing the *effluent* into the *soil* and be constructed in a manner that minimizes the risk of *effluent* breakout through the *soil* used to construct the *berm* of the *treatment mound* covering the sand layer and provide a barrier against direct contact with the *effluent*.
- 2) The design of a *treatment mound* shall meet all requirements set out in Section 8.1.1.

<sup>1</sup> Note: Sentence (2) – See Appendix B-8.4.1.1.(2)

#### 8.4.1.2. Effluent Treatment Quality in Soil

- 1) At a depth of 900 mm (3 ft.) below the bottom of the required thickness of the sand layer and in the *effluent/groundwater* plume at the edge of the *berm*, the treated *effluent* shall meet the following criteria:
  - a) fecal coliform < 10 CFU/100 mL above background levels, or
  - b) fecal coliform < 2MPN/gram of dry *soil* above background levels.
- 2) The *effluent/groundwater* plume shall not exceed background levels of fecal organisms 8 m (25 ft.) horizontally from the *soil-based treatment area*, as measured from the edge of the *treatment mound berm*, including during typical periods of climatic stress and/or typical/maximum designed flow volumes.

#### 8.4.1.3. Sand Layer — Orientation on Slopes

- 1) The geometry of the sand layer shall conform to the surface slope contour of the site it is placed on, such that
  - a) the long axis of the sand layer (its longest dimension), including any 3 m (10 ft.) segment of the sand layer, shall be oriented at 90 degrees to the slope direction;
  - b) the downslope edge of the sand layer where it makes contact with the in situ (original) *soil* surface shall
    - i) be level along its length within 2% as measured from end to end or in any 3-m (10 ft.) segment of the sand layer, and
    - ii) be level within 100 mm (4 in.) as measured within any 600 mm (2 ft.) segment of its length; and
  - c) when placed on a concave or convex slope, with a concave contour, the deflection of curvature of the sand layer where it meets the in situ *soil* will not exceed 15%, as measured by the horizontal deflection from a plane drawn from each end of the sand layer.<sup>1</sup>

<sup>1</sup> Note: Sentence (1) – See Appendix B-8.4.1.3.(1)

- 2) If there is documentation that the direction of groundwater movement is different from the slope of the land, the direction of groundwater movement must be considered in determining the preferred orientation of the sand layer as it relates to groundwater flow direction and *soil* characteristics for the purpose of managing *linear loading* rates and the impact of *groundwater mounding* below the system.

#### 8.4.1.4. Sand Layer — Primary Treated effluent

- 1) The *sand layer* of a *mound* receiving primary treated *effluent* Level 1 shall
- a) have a surface area designed on the basis of an *effluent hydraulic loading rate* of not more than 40 L per square metre (0.83 Imp. gal. per sq. ft.) per day;
  - b) regardless of whether *primary treated effluent* Level 1 or *secondary treated effluent* is applied, have a *sand layer* surface area that does not exceed the *effluent* hydraulic loading rates determined under Articles 8.1.1.2, 8.1.1.3, 8.1.1.4, 8.1.1.5, and 8.1.2.4., and Sentences 8.1.2.2.(2) and (3) if the in situ *soil* is:<sup>1,2</sup>
    - i) *coarse sand*,
    - ii) *medium sand*,
    - iii) *fine sand*,
    - iv) *very fine sand*,
    - v) *loamy coarse sand*,
    - vi) *loamy medium sand*,
    - vii) *loamy fine sand*,
    - viii) *loamy very fine sand*,
    - ix) *coarse sandy loam*, or
    - x) *medium sandy loam*;
  - c) not exceed 3 m (10 ft.) in width, measured at the top of the *sand layer*;
  - d) have a length that takes into account the *effluent hydraulic linear loading rate* limits set out in Article 8.1.2.3. or as determined under Article 8.1.1.7. that are based on *soil texture*, *structure*, consistency, and *infiltration* distance (depth) to seasonally saturated *soil* and restricting conditions at the site;<sup>3</sup>
  - e) be not less than 300 mm (1 ft.) thick; and
  - f) be on or above the existing *soil*.<sup>4</sup>

<sup>1</sup> Note: Clause (1)(b) - See table 8.1.1.10. (A.1.E.1. for imperial loading)

<sup>2</sup> Note: Clause (b) See Appendix B 8.4.1.4.

<sup>3</sup> Note: Clause (1)(d) — Article 8.1.2.3. provides a prescriptive solution for determining acceptable linear loading rates.

<sup>4</sup> Intent: Clause (1)(f) — This Clause requires the mound to be built on the existing grade of the soil. Soil should not be stripped away so as to create a depression in the ground, or be replaced by fill material.

#### 8.4.1.5. Sand Layer — Secondary Treated Effluent

- 1) A *treatment mound* that receives *secondary treated effluent* shall be designed<sup>1</sup>
  - a) using a *sand layer* that has a minimum average thickness of 75 mm (3 in.);
  - b) with a minimum distance of 900 mm (3 ft.) to a *restrictive condition*, as measured from the top surface of the 75 mm (3 in.) sand layer;
  - c) with a *sand layer* surface area designed on the basis of an *effluent hydraulic loading rate* of not more than 40 L per square metre (0.83 Imp. gal. per sq. ft.) per day; and
  - d) with a *sand layer* surface area required to ensure that the *effluent hydraulic loading rate* does not exceed the *effluent* hydraulic loading rates determined under Articles 8.1.1.2., 8.1.1.3., 8.1.1.4., 8.1.1.5., and 8.1.2.4., and Sentences 8.1.2.2.(2) and (3) if the in situ *soil texture* is:
    - i) *coarse sand*,
    - ii) *medium sand*,
    - iii) *fine sand*,
    - iv) *very fine sand*,
    - v) *loamy coarse sand*,
    - vi) *loamy medium sand*,
    - vii) *loamy fine sand*,
    - viii) *loamy very fine sand*,
    - ix) *coarse sandy loam*, or
    - x) *medium sandy loam*.

<sup>1</sup> Note: Sentence (1) – See Appendix B-8.4.1.5.(1)

#### 8.4.1.6. Suitability of In-Situ Soil and Vertical Separation

- 1) A *treatment mound* may be used as a final treatment component where
  - a) the in-situ (original) *soil* has an assigned loading rate as determined by Table 8.1.1.10. to a depth of at least 300 mm (1 ft.), and
  - b) a minimum *vertical separation* of 900 mm (3 ft.) is maintained between the bottom of the required depth of *sand layer* and any *restrictive condition* below the *treatment mound*.<sup>1</sup>

<sup>1</sup> Note: Clause (1)(b) — The *sand layer* receiving the *effluent* may be increased in thickness to provide the *vertical separation* required. Using the same sand as is required for the 300 mm (1 ft.) sand layer is advised. The fill must have a textural classification not finer than *fine sand*. Sand with any significant percentage of silt or clay content should not be used, as it will cause excessive compaction and will be washed down over time through the fill material as the *effluent* is applied, resulting in the development of a *restrictive condition*.

#### 8.4.1.7. Infiltration Into In Situ Soil

- 1) The area of contact with the in situ *soil* that is within the *berm* forming the *mound*, excluding the end slopes, shall provide a *soil infiltration surface* area into the in situ *soil* that
  - a) is not less than the required *soil infiltration surface* area determined by Article 8.1.1.10. using loading rates for *secondary treated effluent* Level 2; and
  - b) when on a slope exceeding 1 percent, includes only the area downslope of the upslope side of the *sand layer* area receiving the *effluent* to the downslope edge of the *berm*.<sup>2</sup>

<sup>1</sup> Intent: Sentence (1) — To ensure that an adequate area of soil is available for the *effluent* to infiltrate into the in situ *soil*, and that the permeability of the *berm* fill material enables the *effluent* to be readily distributed over the *infiltration area* and thereby prevent the *effluent* from mounding in the *sand layer*.

<sup>2</sup> Note: Clause (1)(b) - See Appendix B-8.4.1.7.(1)(b).



- 2) The fill *soil* forming the *berm* covering the required *soil infiltration surface* area required by Sentence (1) shall be a *soil* that has a *soil texture classification* of *coarse sand, medium sand, fine sand, loamy medium sand, or loamy coarse sand*.

#### 8.4.1.8. Distribution of Effluent

- 1) The distribution of *effluent* onto the *sand layer* shall be done using pressure distribution lateral pipes that are located in<sup>1</sup>
- a) a layer of *gravel* over the *sand layer* as set out in Article 8.4.2.5, or
  - b) chambers that provide an effective *effluent* infiltrative area within the internal opening area of the chambers over the *sand layer* that is not less than 80% of the required sand layer area determined by the design *effluent hydraulic loading rate*.

<sup>1</sup> *Intent: Sentence (1) — The actual open area under the chambers providing direct effluent contact with the sand layer must comprise at least 80% of the required area. The internal dimensions of the chamber need to be measured, as there is normally a significant footprint area of the chambers that covers a portion of the sand layer. The gravel layer or chambers must provide a void space for temporary storage of the effluent delivered during a dose event and during peak flow periods.*

#### 8.4.1.9. Using Chambers

- 1) Where chambers are used, a pressure *effluent distribution lateral pipe* shall be provided for each of the chamber–*sand layer* contact areas provided by the chambers.

#### 8.4.1.10. Maximum Dose Volume

- 1) The design of the *treatment mound* and pressure *distribution lateral pipe system* shall be based on achieving the ability to deliver individual doses of *effluent* over the entire *sand layer* area that do not exceed 20% of the average daily *effluent* volume.<sup>1,2</sup>

<sup>1</sup> *Intent: Sentence (1) — Smaller doses provide better treatment conditions. Doses may be smaller than 20%. A 20% dose volume results in 5 doses per day. The entire sand layer does not have to be dosed during an individual dose event; however, the design must ensure that each area of the sand layer served by an individual orifice receives not more than 20% of the average daily flow. For example, if a distribution system was designed with 2 alternating zones, the system needs to be designed on the basis of 10 doses per day in total — 5 doses for each zone.*

<sup>2</sup> *Note: Sentence (1) - See Appendix B-8.4.1.10.(1).*

#### 8.4.1.11. Pressure Distribution Required

- 1) Distribution of *effluent* shall be achieved using a pressure *distribution lateral pipe system* meeting the requirements of Section 2.6. and effectively distribute the *effluent* as set out in Article 8.4.2.6.

#### 8.4.1.12. Effluent Ponding Monitoring Pipes

- 1) The *mound* design shall include *effluent* ponding monitoring pipes to enable monitoring of the depth of *effluent* ponding at the *sand layer infiltration surface* and at the *sand layer*–in situ *soil* interface.

- 2) At a minimum there shall be<sup>1</sup>
- a) 2 *effluent* ponding monitoring pipes to monitor the depth of *effluent* ponding at the interface of the sand layer and in situ *soil*, each one located at a quarter of the length of the sand layer and not more than 4.5 m (15 ft.) from each end of the sand layer, and along the centre line of the sand layer on a site having less than a 1% slope or on the downslope side of the sand layer, if on a slope greater than 1%; and
  - b) *effluent* ponding monitoring pipes shall be provided to monitor ponding of *effluent* on the sand layer *infiltration* surface and be located within 1.5m (5 ft.) of each end of the sand layer and, if chambers are used, an *effluent* ponding monitoring pipe shall be provided at those positions for each continuous row of chambers.

<sup>1</sup> Note: Sentence (2) – See Appendix B-8.4.1.12.

- 3) The *effluent* ponding monitoring pipe shall
- a) be a minimum of 100 mm (4 in.) in *diameter* and extend to finished *grade*;
  - b) be fitted with a manufactured access box; and
  - c) be provided with perforations that
    - i) allow entry of ponded *effluent* while excluding the sand or *gravel* media surrounding the access port, and
    - ii) are located within the vertical section of the *mound* they are intended to monitor the depth of ponded *effluent* in, as required by Sentence (1) or (2).

#### **8.4.2. Treatment Mounds — Prescriptive Requirements and Installation Standards**

##### **8.4.2.1. Separation Distances**

- 1) A *treatment mound* shall not be located within
- a) 15 m (50 ft.) of a *water source* or *water well*;
  - b) 100 m (330 ft.) from a licensed municipal *water well*;
  - c) 15 m (50 ft.) of a *water course*, except as provided in Article 2.1.2.4.;
  - d) 3 m (10 ft.) of a *property* line;
  - e) 3 m (10 ft.) of a *septic tank*;
  - f) 10 m (33 ft.) of a basement, cellar, or crawl space; and
  - g) 10 m (33 ft.) of a *building* that does not have a basement, cellar, or crawl space.
- 2) For the purposes of Sentence (1), all measurements are to be taken from the point where the side slope of the *mound berm* intersects with the natural *soil* contour.

##### **8.4.2.2. Diverting Run-off Water**

- 1) Whenever treatment mounds are located on slopes, a diversion shall be constructed immediately upslope of the upper side of the *mound berm* to intercept and direct run-off water away from the *mound*.

##### **8.4.2.3. Sand Layer Thickness**

- 1) The *sand layer* that primary treated *effluent* Level 1 is distributed over shall be a minimum of 300 mm (1 ft.) thick, and the top of the *sand layer* shall be *nominally level*.

**8.4.2.4. Placement of Sand Layer**

- 1) The *sand layer* and fill material shall be put in place using methods that minimize compaction of the *soil* under the *sand layer* and prevent smearing or glazing of the *soil* under the *mound* area that would be at least equivalent to using track-type machinery and ensuring at least 150 mm (6 in.) of sand is kept beneath the track-type machinery.
- 2) The in situ *soil* shall be broken up and the sand layer material and *berm* fill material shall be integrated into the in situ *soil*.<sup>1</sup>

<sup>1</sup> Note: Sentence (2) – See Appendix B-8.4.2.4.(2).

**8.4.2.5. Pipe and Gravel Application**

- 1) When *gravel* is used over the sand layer,
  - a) not less than 150 mm (6 in.) of *gravel* shall be placed over the contact area below the distribution lateral pipes;
  - b) not less than 25 mm (1 in.) of *gravel* shall be placed over the distribution lateral pipes; and
  - c) the *gravel* layer shall be covered with
    - i) straw or equivalent fibrous material to an un-compacted depth of 75 mm to 100 mm (3 to 4 in.), or
    - ii) a *geotextile fabric* suitable for the purpose of preventing the migration of the covering *soil* into the *gravel* while allowing the movement of air and water.

**8.4.2.6. Orifice Spacing over Sand Layer**

- 1) The pressure *effluent distribution lateral pipe* supplying *effluent* to the *sand layer* shall be spaced evenly over the sand layer with orifice spacing that provides 1 orifice for every 0.5 square metres (5.5 sq. ft.) or less of the sand layer.

**8.4.2.7. Mound Berm Fill Material**

- 1) *Coarse sand, medium sand, fine sand, loamy medium sand, or loamy coarse sand* fill material shall be used to form the *berm* of the overall *mound* required to cover the *soil infiltration surface* area and it shall be<sup>1</sup>
  - a) placed to a minimum depth of 150 mm (6 in.) at the sides of the *sand layer*, and
  - b) provide a slope to ensure drainage of surface water from the *mound*.

<sup>1</sup> Intent: Sentence (1) — To provide an adequate slope on the top of the treatment mound in order to prevent storm water from standing on the top of the mound. A minimum 4% slope (0.5 inch per foot) is recommended.

**8.4.2.8. Mound Berm Cover Material**

- 1) In addition to Article 8.4.2.7., 75 mm (3 in.) of *soil* having a *texture* not finer than sandy loam, and not coarser than loamy fine sand shall be placed over the fill material to cover the entire area of the *mound* in order to support a grass cover.

#### 8.4.2.9. Mound Berm Grass Cover

- 1) A vegetative (grass) cover shall be established over the entire area of the *mound*.<sup>1</sup>

<sup>1</sup> *Intent: Sentence (1) – a contractor meets the requirements of this Sentence by seeding the mound to grass, leaving the owner the responsibility to water and maintain the grass cover. The grass cover is needed to prevent erosion of the mound and to assist in evaporating the effluent.*

#### 8.4.2.10. Side Slopes of Mound

- 1) The side slopes of the *mound* shall not be steeper than 1:3 (one vertical to 3 horizontal).

### 8.4.3. Treatment Mounds — Requirements for Materials

#### 8.4.3.1. Sand

- 1) Sand used for the *sand layer* shall have
  - a) a particle-size distribution that meets
    - i) the concrete sand specification provided in CAN/CSA-A23.1, “Concrete Materials and Methods of Concrete Construction.”

#### 8.4.3.2. Drain Media

- 1) *Drain media* used in a *mound* shall
  - a) consist of clean washed *gravel*, clean crushed rock, or other equivalent media that will maintain structural integrity and not be degraded by the environment created in the *soil* treatment area;
  - b) have a particle-size distribution by weight of
    - i) 100 percent passing the 50 mm, (2 in.) sieve,
    - ii) 0 to 25 percent passing the 12.5 mm, (½ in.) sieve,
    - iii) 0 to 10 percent passing the 9.51 mm ( 3/8 in.), sieve,
    - iv) 0 to 2 percent passing the 1.18 mm (3/64 in.), No. 16 sieve, and
    - v) 0 to 1 percent passing the 0.15 mm (0.0059 in.) No, 100 sieve; and
  - c) be able to withstand vertical and horizontal loads from backfill equal to a minimum of 1 m (3.25 ft.) of earth cover.

#### 8.4.3.3. Chambers

- 1) *Infiltration* chambers shall be *certified* as meeting IAPMO PS 63-2019 Plastic Leaching Chambers as amended or replaced from time to time.
- 2) All Chambers shall meet or exceed the loading requirements of the American Association of State Highway and Transportation Officials H -10 or H -20 ratings as referenced in the IAPMO PS 63-2019 standard.

## Section 8.5. Sub-surface Drip Dispersal and Irrigation

### 8.5.1. Sub-surface Drip Dispersal and Irrigation — Objectives and Design Standards

#### 8.5.1.1. General

- 1) The design of a subsurface drip dispersal system shall meet all requirements set out in Section 8.1.<sup>1</sup>

<sup>1</sup> Note: Sentence (1) – See Appendix B-8.5.1.1.(1)

#### 8.5.1.2. Effluent Treatment Quality in Soil

- 1) At a depth of 900 mm (3 ft.) below the drip dispersal lines and in the *wastewater effluent/groundwater* plume at a distance of not more than 900 mm (3 ft.) from the edge of the *soil-based treatment area*, the treated *effluent* shall meet the following criteria:<sup>1</sup>
  - a) fecal coliform < 10 CFU/100 mL above background levels, or
  - b) fecal coliform < 2 MPN/gram of dry *soil* above background levels.

<sup>1</sup> Note: Sentence (1) – See Appendix B-8.5.1.2.(1)

- 2) The *effluent/groundwater* plume shall contain no viable fecal organisms 8 m (27 ft.) horizontally from the *soil-based treatment area*, as measured from the edge of the *soil-based treatment area*, including during typical periods of climatic stress and/or typical maximum designed flow volumes.

#### 8.5.1.3. Required Effluent Quality and SAR Limits

- 1) *Effluent* delivered to a drip dispersal system shall be treated to a<sup>1</sup>
  - a) *secondary treated effluent* Level 2 standard or better, and
  - b) *secondary treated effluent* Level 3–D2 standard or better when the drip tubing is installed with less than 300 mm (1 ft.) of cover.

<sup>1</sup> Note: Sentence (1) – See Appendix B-8.5.1.3.(1).

- 2) *Effluent* shall have an SAR of less than 10 when the drip dispersal tubing is placed at a depth of less than 450 mm (18 in.) below ground surface and the *effluent* hydraulic loading rates are selected to meet typical irrigation needs (as opposed to *effluent* dispersal at the rates set out in this Standard) to prevent negative impact on vegetation at the ground surface due to the accumulation of sodium in the root zone of the vegetation.<sup>1</sup>

<sup>1</sup> Note: Sentence (2) – See Appendix B-8.5.1.3.(2)

#### 8.5.1.4. Dispersal

- 1) The drip dispersal system shall be designed to prevent instantaneous loading during a dose event from saturating the *soil* within 50 mm (2 in.) of the ground surface.
- 2) The geometry and orientation of the drip dispersal area shall not cause the hydraulic loading to exceed the *linear loading* capacity of the *soil* as determined in Article 8.1.1.7. or 8.1.2.3.

**8.5.1.5. Winter Use Restrictions and Design**

- 1) Where the system is used for a *development* that requires *wastewater* treatment during the period of November 30 to March 31<sup>1</sup>
  - a) the system shall be protected from freezing and all piping sloped to ensure drainage of all piping back to the dose tank, and
  - b) an alternate system meeting the requirements of this Standard shall be provided for use in the event the drip distribution system freezes.

<sup>1</sup> Note: Sentence (1) – See Appendix B-8.5.1.5.(1)

**8.5.1.6. Effluent Loading Rates**

- 1) The *effluent* hydraulic loading rates shall not exceed those set out in Table 8.1.1.10. or otherwise restricted by this Standard.
- 2) The *effluent soil infiltration surface* area supplied by a single drip dispersal tube shall be considered to be no more than 300 mm (12 in.) on either side of the drip dispersal tubing for a total calculated *soil infiltration surface* width of not more than 600 mm (2 ft.) per drip dispersal lateral.

**8.5.1.7. Drip Dispersal Tubing Layout and Dosing Design**

- 1) The drip dispersal tubing shall be equipped with pressure compensating orifices.<sup>1</sup>

<sup>1</sup> Note: Sentence (1) – See Appendix B-8.5.1.7.(1).

- 2) A means of preventing root intrusion into the emitters/orifices shall be provided in the system design.<sup>1</sup>

<sup>1</sup> Note: Sentence (2) – See Appendix B-8.5.1.7.(2)

- 3) The system shall have a means of inhibiting bacterial growth and the accumulation of slime in the emitters/orifices.
- 4) A minimum of 1 orifice shall be provided for each 0.37 square metres (4 sq. ft.) of *soil infiltration* surface area.<sup>1</sup>

<sup>1</sup> Note: Sentence (4) – See Appendix B-8.5.1.7.(4).

- 5) The system shall be dosed using timed dosing controls to ensure that dosing events occur at evenly spaced intervals over a 24-hour period.
- 6) Drip dispersal tubing shall have orifices that have a rated flow of not more than 2 L per hour (0.44 Imp. gal. per hour or 0.53 U.S. gal. per hour) when installed in *soil* that has a *texture* of
  - a) *sandy clay loam*,
  - b) *clay loam*,
  - c) *silty clay loam*,
  - d) *sandy clay*,
  - e) *clay*,
  - f) *silty clay*, or
  - g) *heavy clay*.

- 7) Drip dispersal tubing shall be installed
  - a) following the slope contour,
  - b) as level as possible, and
  - c) at a depth of between 150 mm (6 in.) and 900 mm (36 in.) below finished *grade*.

#### 8.5.1.8. Drip Dispersal Tubing Flushing Requirements

- 1) The system shall be capable of flushing all parts of the drip dispersal piping at a minimum flow velocity of 0.6 m/s (2 ft/s).<sup>1</sup>

<sup>1</sup> Note: Sentence (1) — Backwashing/flushing with a return to a location set out in Sentence (3) may be done continuously or periodically based on a pre-set interval, the number of dosing cycles, or the measurement of pressure difference across the filter (such as a 20% difference in pressure), or any combination of these criteria.

- 2) The volume of a flushing dose shall be at least twice the volume of all pressurized piping.
- 3) The return line used to facilitate flushing shall return to the *building sewer* where it connects to an initial treatment component, or into an initial treatment component in a manner that does not result in undesirable disturbance of the *settling tank* or *septic tank*.

#### 8.5.1.9. Operational Control Required

- 1) The operation of a drip dispersal system of any capacity shall be managed using a control panel that can
  - a) monitor the volume per flow event and per day applied to the *soil*;<sup>1</sup>
  - b) provide for automatic flushing of filters and drip laterals with filtered *effluent*, initiated by a timer and/or a pre-set pressure differential across the filters;
  - c) deliver designer-specified volumes of *effluent* to each field zone (adjustable and variable between zones) at designer-specified time intervals;
  - d) monitor alarm conditions (e.g., high water, power outage);
  - e) monitor flow variance and provide indication of when flow is  $\pm 20\%$  of design, indicating servicing is required;
  - f) monitor pump run times;
  - g) monitor numbers and times of filter and field flushing cycles;
  - h) record the operational events for a minimum of the previous 30 days; and
  - i) meet any additional requirements for *system* controls set out in Sections 2.3. and 2.4.

<sup>1</sup> Note: Clause (1)(a) — This may be accomplished by the ability of a control system to count and record dose events and pump run times during a 24 hr. period.

**8.5.2. Sub-surface Drip Dispersal and Irrigation —  
Prescriptive Requirements and Installation Standards**

**8.5.2.1. Separation Distances**

- 1) An *effluent* drip dispersal system, measured from any part of the drip dispersal tubing, shall not be located within<sup>1</sup>
  - a) 15 m (50 ft.) of a *water source* or *water well*;
  - b) 100 m (330 ft.) of a licensed municipal *water well*;
  - c) 15 m (50 ft.) of a *water course*, except as required by Article 2.1.2.4.;
  - d) 1.5 m (5 ft.) of a *property line*;
  - e) 10 m (33 ft.) of a basement, cellar, or crawl space, except that this distance may be reduced to 1.5 m (5 ft.) when the system is used specifically for irrigation and the *effluent* hydraulic loading rates do not exceed irrigation needs;<sup>2</sup>
  - f) 1 m (3.25 ft.) of a *building* that does not have a permanent foundation;
  - g) 5 m (17 ft.) of a *building* that has a permanent foundation but does not have a basement, cellar, or crawl space, except that this distance may be reduced to 1.5 m (5 ft.) when the system is used specifically for irrigation and the *effluent* hydraulic loading rates do not exceed irrigation needs; and
  - h) 5 m (17 ft.) of a *septic tank* or packaged *sewage* treatment plant, except that this distance may be reduced to 1.5 m (5 ft.) when the system is used specifically for irrigation and the *effluent* hydraulic loading rates do not exceed irrigation needs.

<sup>1</sup> Note: Sentence (1) - See Appendix B-8.5.2.1.(1).

<sup>2</sup> Note: Clause (1)(d) — The 10 m (33 ft.) requirement to a cellar, basement, or crawl space is intended to protect excavations below grade from accumulating migrating effluent. A crawlspace that is not below grade, or where the level of the ground surface at the soil-based treatment area is below the level of the crawlspace, would not require 10 m (33 ft.) clearance and could be treated as a building with a permanent foundation without a basement.

**8.5.2.2. Prohibited Locations**

- 1) An *effluent* drip dispersal system shall not be located under
  - a) a roadway or driveway,
  - b) a paved area,
  - c) a vehicle parking lot,
  - d) any *structure*, or
  - e) a vegetable garden.

**8.5.2.3. Linear Loading Limits**

- 1) The arrangement of the drip dispersal tubing shall ensure that the maximum *linear loading* as set out in Table 8.1.1.10. or determined in accordance with Article 8.1.1.7. is not exceeded.

**8.5.2.4. Clean-outs and Piping Access**

- 1) Clean-outs shall be provided for the supply and return piping.<sup>1</sup>

<sup>1</sup> Note: Sentence (1) – See Appendix B-8.5.2.4.(1)

- 2) Access from the ground surface shall be provided to all valves, air release/intake valves, filters, and the 2 drip emitters located along the highest and lowest orifices.



#### 8.5.2.5. Manufacturer's Recommended Practices

- 1) A drip dispersal system shall be installed following all of the manufacturer's recommendations except where the manufacturer's recommendations conflict with the requirements of this Standard, in which case the requirements of this Standard shall apply.<sup>1</sup>

<sup>1</sup> Note: Sentence (1) – See Appendix B-8.5.2.5.(1)

### 8.5.3. Sub-surface Drip Dispersal and Irrigation — Requirements for Materials

#### 8.5.3.1. Piping

- 1) Piping other than sub-surface drip dispersal tubing used in a drip dispersal system shall comply with the requirements of Section 2.5.<sup>1</sup>

<sup>1</sup> Note: Sentence (1) – See Appendix B-8.5.3.1.(1)

- 2) Sub-surface drip dispersal tubing shall
  - a) have a warranty provided by the manufacturer for use with *wastewater* and for resistance to root intrusion;
  - b) incorporate emitters with a maximum nominal rated discharge of 3.64 L (0.8 Imp. gal.) per hour, except where required to be less, as set out in Sentence 8.5.1.7.(6); and
  - c) be colour-coded purple or permanently marked at 1 m (3.25 ft.) intervals to identify that the pipe contains non-potable water from a *wastewater* source.
- 3) The emitter discharge rate referred to in Clause (2)(b) may be controlled by the use of pressure-compensating emitters.
- 4) Equipment used in a drip dispersal system must be specifically designed and intended for use in a drip dispersal system or recommended by the manufacturer for that use.

## Section 8.6. LFH At-Grade Treatment Systems

### 8.6.1. LFH At-Grade Treatment Systems—Objectives and Design Standards

#### 8.6.1.1. General

- 1) An *LFH At-grade system* shall meet the following objectives:<sup>1</sup>
  - a) break down the *organic loading* contained in the *effluent*,
  - b) provide an area of *soil* over which the *effluent* is spread to reduce the hydraulic and *organic loading* on each part of the *soil infiltration surface*,
  - c) spread the *effluent* over a suitably sized area to enable sufficient oxygen to be transferred through the *soil* in order to achieve treatment objectives and long-term utilization, and
  - d) introduce the *effluent* into the *soil* and be constructed in a manner that minimizes the risk of *effluent* breakout through the material covering the *soil infiltration surface* area that provides a barrier against direct contact with the *effluent*.

<sup>1</sup> Note: Sentence (1) – See Appendix B-8.6.1.1.(1).

- 2) The design of an *LFH At-grade system* shall meet all requirements and objectives set out in Section 8.1.

#### 8.6.1.2. Effluent Treatment Objectives in Soil

- 1) An *LFH At-grade system* shall treat the applied *effluent* as it migrates through the *soil*, as measured at the *vertical separation treatment boundary limit* required for the design and *effluent* quality being applied, to the following quality:
  - a) fecal coliform < 10 cfu/100 mL above background levels, or
  - b) fecal coliform < 2 MPN/gram of dry *soil* above background levels.

#### 8.6.1.3. Applied Effluent Quality

- 1) The *effluent* applied to the *soil infiltration surface* of an *LFH At-grade system* shall meet a secondary treatment standard Level 2 as set out in Article 5.1.1.1. or better quality.

#### 8.6.1.4. Located in Forested Area

- 1) The *LFH At-grade system* shall be located in a forested area that
  - a) provides shelter from the cooling effect of winds and also maximizes snow cover over the *system*, and
  - b) has a minimum 50 mm (2 in) LFH layer that allows the relatively fast horizontal spread of the applied *effluent* over the *soil-based treatment area* that is under the cover material of the system.<sup>1</sup>

<sup>1</sup> Note: Clause (1)(b) – See Appendix B-8.6.1.4.(1)(b)

**8.6.1.5. Cover Material and Stability**

- 1) The material covering the *LFH At-grade system soil infiltration surface* area shall be consistent with the ecology of the forested area and be effective at minimizing the risk of direct contact with the *effluent* by humans and animals.<sup>1,2</sup>

<sup>1</sup> Note: Sentence (1) – The cover material typically used is wood chips/bark mulch. Sawdust and wood-planing by product is not an acceptable cover material. Wood chips/bark mulch are suitable with the forest ecology where these systems are to be installed. The wood chips/bark mulch allow the forest undergrowth to grow through the cover material, consolidating the entire system into the forest floor over time. This is important to minimize the risk of direct contact with the effluent by people or animals.

<sup>2</sup> Note: Sentence (1) – See Appendix B-8.6.1.5.(1)

- 2) The depth of the cover material shall be a minimum of 230 mm (9 in.) above the *infiltration* chambers after settlement of the cover material occurs.<sup>1</sup>

<sup>1</sup> Note: Sentence (2) – The depth of the cover material at time of installation will need to be substantially more than 230 mm (9 in.) to allow for settling and still achieve a minimum 230 mm (9 in.) cover after settlement. Fresh wood chips will settle substantially while old weathered wood chips will not settle as much. Anticipating that fresh wood chips may settle by 50% is not unreasonable.

- 3) The slope of the cover material shall be minimized to prevent slumping and loss of cover depth, or be stabilized using acceptable methods.<sup>1</sup>

<sup>1</sup> Note: Sentence (3) – See Appendix B-8.6.1.5.(3)

- 4) The cover material shall extend a sufficient distance beyond the *infiltration* chambers to ensure that the *effluent* applied at the design *effluent hydraulic loading rate* infiltrates into the *soil* within the cover material to prevent risk of direct contact.

**8.6.1.6. Effluent Loading Rates**

- 1) The *effluent hydraulic loading rate* on the *soil infiltration surface* directly under the *infiltration* chambers shall not exceed 40.7 litres per sq. metre per day (0.83 gal./sq. ft./d) or as limited by Sentences 8.1.2.2 (2) and 8.1.2.2 (3) to achieve effective treatment of the *effluent*.
- 2) Notwithstanding Sentence (1),
  - a) the area provided by the actual internal open area of the chamber needs to cover a minimum of 80% of the required *soil infiltration surface* area determined under Sentence (1), or
  - b) the *effluent hydraulic loading rate* can be increased by a factor as allowed by article 8.3.1.5.
- 3) The design *effluent hydraulic loading rate* on the *soil infiltration surface* area under the *LFH At-grade system* cover material shall not exceed the values set out in Table 8.1.1.10.<sup>1</sup>

- 4) The *soil infiltration surface* area required by Sentence (3) shall include the area covered by the *infiltration* chambers and the cover material
- a) on both sides of the *infiltration* chamber when the slope is less than 1%, or
  - b) only on the downslope side of the *infiltration* chamber when the system is on a slope greater than 1%.

<sup>1</sup> Note: Sentence (3) — The total area covered by both the *infiltration* chambers and cover material, as set out in Sentence 4, is determined by dividing the peak daily wastewater flow by the allowed effluent hydraulic loading rate set out in Table 8.1.1.10. for the soil at the site.

#### **8.6.1.7. Time Controlled Pressure Distribution of Effluent Required**

- 1) *Effluent* shall be distributed using an *effluent pressure distribution lateral pipe system* meeting the design requirements and objectives of Subsection 2.6.1.<sup>1</sup>

<sup>1</sup> Note: Sentence (1) – See Appendix B-8.6.1.7.(1)

- 2) Time controlled dosing of the individual doses of *effluent* applied to the *LFH At-grade system* shall be evenly spread over a 24-hr. period, and the volume of each *effluent* dose shall be minimized to achieve as many doses as possible in a 24-hr. period based on system design flows.

#### **8.6.1.8. System Geometry and Linear Loading Rate Design**

- 1) The design and geometry of the *effluent soil-based treatment area* of the *LFH At-grade system* shall result in an *effluent hydraulic linear loading rate* that does not exceed the *soil* profile's capability to allow the horizontal movement of the *effluent* away from the treatment system when downward vertical *effluent* flow will be restricted and shall be designed to meet<sup>1</sup>
- a) the values set out in Table 8.1.1.10. that relate horizontal movement of *effluent* through the *soil* to the characteristics of the *soil* profile and the slope of the landscape; or
  - b) a comprehensive and documented assessment and calculation of the *soil's* capacity to transmit the *effluent* horizontally, as set out in Article 8.1.1.9.

<sup>1</sup> Note: Sentence (1) – See Appendix B-8.6.1.8.(1)

#### **8.6.1.9. Orientation on Slopes**

- 1) The geometry of the *LFH At-grade system* shall conform to the surface slope contour of the site it is placed on such that
- a) the long axis of the *LFH At-grade system*, including any 3 m (10 ft.) segment of the *LFH At-grade system*, shall be oriented at 90 degrees to the slope direction; and
  - b) the downslope edge of the *LFH At-grade system* where it makes contact with the in situ *soil* surface shall
    - i) be level along its length within 2% as measured from end to end or in any 3 m (10 ft.) segment of the *LFH At-grade system*,
    - ii) be level within 100 mm (4 in.) as measured within any 600 mm (2 ft.) segment of its length, and
    - iii) when placed on a concave or convex slope with a concave contour, the deflection of curvature of the *LFH At-grade system* where it meets the in situ *soil* will not exceed 15%, as measured by the horizontal deflection from a plane drawn from each end of the *LFH At-grade system*.

## 8.6.2. LFH At-Grade Treatment Systems – Prescriptive Requirements and Installation Standards

### 8.6.2.1. Separation Distances

- 1) An *LFH At-grade system* shall not be located within
  - a) 15 m (50 ft.) of a *water source* or *water well*;
  - b) 100 m (330 ft.) of a municipal licensed *water well*;
  - c) 15 m (50 ft.) of a *water course*, except as restricted in Article 2.1.2.4.;
  - d) 3 m (10 ft.) of a *property line* where the ground is level or slope is less than 1%;
  - e) 6 m (20 ft.) of a *property line* that is located downslope of the *LFH At grade system* where the slope is 1% or more;
  - f) 3 m (10 ft.) of a *septic tank*, packaged sewage treatment plant, *effluent tank*, or other tank in the system; and
  - g) 10 m (33 ft.) of a *building*.
- 2) For the purposes of Sentence (1), all measurements are to be taken from the point where the side slope of the cover material intersects with the natural *soil* contour.

### 8.6.2.2. Infiltration Chambers Covering the Effluent Pressure Distribution Laterals

- 1) Each distinct row of *infiltration* chambers that provide the direct *soil infiltration surface* area required for the *LFH At-grade system* shall include at least 1 *effluent pressure distribution lateral pipe* that has orifices spaced at not more than 600 mm (2 ft.) apart and that meets the requirements of Section 2.6.
- 2) Chambers shall meet the requirements set out in Sub-section 8.6.3.

### 8.6.2.3. Individual Infiltration Chamber Laterals Level Throughout Length

- 1) Each lateral that consists of the *effluent pressure distribution lateral pipe* and covering *infiltration* chamber shall be level along the long axis within
  - a) 2% end to end,
  - b) 2% within any 3 m (10 ft.) segment of the lateral, and
  - c) 10 cm (4 in.) within any 600 mm (2 ft.) segment.

### 8.6.2.4. Design for 5 Individual Doses Per Day

- 1) The design of the *pressure distribution lateral pipe system*, the *effluent tank*, and pump control settings shall be based on achieving the ability to deliver individual doses of *effluent* that do not exceed 20% of the design average daily *effluent* volume over the entire *LFH At-grade system*.<sup>1,2</sup>

<sup>1</sup> *Intent: Sentence (1) — Smaller individual-dose volumes provide better treatment conditions and minimize the chance that the effluent will break out of the At-grade system due to a large individual-dose volume. Doses may be smaller than 20%. A 20% dose volume results in 5 doses per day. The entire At-grade systems does not have to be dosed during an individual dose event; however, the design must be based on each dosed area of the At-grade system receiving 5 doses of effluent per day based on average daily flow. For example, if a distribution system was designed with 2 alternating zones, the system needs to be designed on the basis of 10 doses per day in total — 5 doses for each zone. Timed doses shall be spaced evenly throughout a 24hr period, See Article 8.6.1.7.*

<sup>2</sup> *Note: Sentence (1) - See Appendix B-8.6.2.4.(1)*

**8.6.2.5. Cover Material Depth, Slope, and Stabilization**

- 1) The cover material shall be a minimum of 225 mm (9 in.) in thickness over all *infiltration* chambers in the *LFH At-grade system* when settled.<sup>1</sup>

<sup>1</sup> Note: Sentence (1) – The depth of the cover material at time of installation will need to be substantially more than 230 mm (9 in.) to allow for settling and still achieve a minimum 230 mm (9 in.) cover after settlement. Fresh wood chips will settle substantially while old weathered wood chips will not settle as much. Anticipating that fresh wood chips may settle by 50% is not unreasonable.

- 2) The cover material shall consist of materials set out in Article 8.6.3.2.
- 3) The placed cover material shall have a maximum slope of
  - a) 1 vertical to 2 horizontal when no stabilization method is used, or
  - b) 1 vertical to 1 horizontal when acceptable geo-tech erosion control and slope stabilizing material is used to contain and stabilize the cover material.

<sup>1</sup> Note: Sentence (3) – See Appendix B-8.6.2.5.(3).

**8.6.2.6. Minimize Impact on LFH Layer and Underlying Soil During Construction**

- 1) The LFH layer of the *soil* profile shall not be removed in the area of the *LFH At-grade system*.
- 2) Brush and small trees shall be cut off at ground level, not pulled out of the ground.
- 3) The installation shall be carried out in a manner that minimizes compaction of the *soil* under the *LFH At-grade system* and the downslope side of the *LFH At-grade system*.

**8.6.2.7. Effluent Monitoring Access Ports**

- 1) The *LFH At-grade system* shall include access ports into the *infiltration* chambers that have a minimum dimension of 100 mm (4 in.) and that terminate at the surface of the cover material in order to enable monitoring the depth of *effluent* ponding and *soil* moisture conditions at the *soil infiltration surface*.<sup>1</sup>

<sup>1</sup> Note: Sentence (1) – See Appendix B-8.6.2.7.(1)

- 2) At a minimum, there shall be 2 access ports as required by Sentence (1), each one located not more than 4.5 m (15 ft.) from each end of a continuous row of *infiltration* chambers that cover an individual *effluent pressure distribution lateral pipe*.
- 3) The access ports required by Sentence (1) shall
  - a) be accessible from the surface of the cover material at finished elevation,
  - b) be fitted with a mechanically fastened top to prevent the entry of foreign material,
  - c) allow viewing of both the *infiltration* chamber interior and *soil infiltration surface*, and
  - d) provide access for sampling of the *soil infiltration surface*.

**8.6.3. LFH At-Grade Treatment System - Material Requirements**

**8.6.3.1. Infiltration Chamber**

- 1) *Infiltration* chambers shall be *certified* as meeting IAPMO PS 63-2019 Plastic Leaching Chambers as amended or replaced from time to time.
- 2) All chambers shall meet or exceed the requirements of the American Association of State Highway and Transportation Officials H -10 or H -20 ratings as referenced in the IAPMO PS 63-2019 standard.

**8.6.3.2. Cover Material**

- 1) The cover material used shall be
  - a) Bark mulch/wood chips of a size that easily allows the grain of the wood to be seen (sawdust or wood-planing by-product is not acceptable), or
  - b) peat moss that is seeded with a vegetative cover that will stabilize the peat moss.
- 2) Material used to stabilize cover material shall be a geo-tech erosion control and stabilizing material that
  - a) will hold the *LFH At-grade system* cover material in place to prevent slumping from mechanical or natural forces, and
  - b) is made of a decomposable material.

## Section 8.7. Open Discharge Systems

### 8.7.1. Open Discharge Systems— Objectives and Design Standards

#### 8.7.1.1. General

- 1) The design of an *open discharge system* shall meet all requirements set out in Section 8.1. except for the *effluent hydraulic loading rates*.
- 2) An *open discharge system* shall not be used on soils that have a *soil texture classification* of *coarse sand, medium sand, fine sand, loamy medium sand, or loamy coarse sand* within 1.5 m (5 ft.) of the ground surface.<sup>1</sup>

<sup>1</sup> *Intent: Sentence (2) — The soil the effluent is discharged onto must have a textural class that will encourage the spreading of effluent, as opposed to allowing the effluent to quickly enter the soil in a concentrated area causing saturated flow.*

- 3) The design and location of an *open discharge system* that discharges *effluent* onto the surface of the ground must ensure that the *effluent* is contained on the *property*.
- 4) An *open discharge system* shall be designed to minimize the pooling of *effluent* on the ground surface.
- 5) The design of the *open discharge system* outlet and the landscaping of the area of the *open discharge system* shall ensure that the *effluent* does not migrate more than 30 m (100 ft.) before infiltrating into the ground.

#### 8.7.1.2. Preventing Erosion

- 1) The *soil* that the *effluent* is discharged onto shall be protected from erosion caused by the discharge of *effluent* from the outlet.<sup>1</sup>

<sup>1</sup> *Intent: Sentence (1) — The design of the point of discharge must include landscaping to effectively disperse the effluent while also protecting the soil from erosion.*

### 8.7.2. Open Discharge — Prescriptive Requirements and Installation Standards

#### 8.7.2.1. Separation Distances

- 1) An *open discharge system* may be installed in a location that provides separation distances from the point of discharge of not less than
  - a) 50 m (165 ft.) to a *water source* or *water well*,
  - b) 100 m (330 ft.) from a licensed municipal *water well*
  - c) 45 m (150 ft.) to a *water course* except as required by Article 2.1.2.4.,
  - d) 90 m (300 ft.) to a *property* line, and
  - e) 45 m (150 ft.) to a *building*.
- 2) The *effluent* discharge piping shall be buried to at least the point where the separation distances set out in Sentence (1) are met.<sup>1</sup>

<sup>1</sup> *Note: Sentence (2) – See Appendix B-8.7.2.1.(2)*



**8.7.2.2. Open Discharge Prohibited**

- 1) An *open discharge system* shall not be installed on a property located within a quarter section where more than 4 parcels have been subdivided out of the quarter section, excluding the remnant of the quarter.<sup>1,2</sup>

<sup>1</sup> Intent: Sentence (1) — Existing systems may remain in operation but once the number of subdivided parcels exceeds 4, additional open discharge systems are not allowed.

<sup>2</sup> Note: Sentence (1) - See Appendix B-8.7.2.2.(1)

- 2) An *open discharge system* shall not be used where the strength of *effluent* exceeds the quality of primary treated *effluent* Level 1.
- 3) For an *open discharge system* exceeding 3 m<sup>3</sup> (660 Imp. gal.) see Article 8.7.2.3.

**8.7.2.3. Multiple Open Discharge Systems**

- 1) Where the expected peak volume of *wastewater* per day, as determined by Section 2.2., exceeds 3 m<sup>3</sup> (660 Imp. gal.) per day, multiple discharge outlets shall be used to reduce the impacts of single point loading.
- 2) Where there are multiple *open discharge systems* or multiple *developments* on a *property*, or there are no *property* lines in the area being developed, the distance between the open discharge outlets shall be a minimum of 180 m (600 ft.). Except where the combined expected peak flow is less than 4.09 m<sup>3</sup> (900 Imp. gal.) the distance between the open discharge outlets shall be at least 30 m (100 ft.)<sup>1</sup>

<sup>1</sup> Note: Sentence (2) – See Appendix B-8.7.2.3.(2)

**8.7.2.4. Soil Test Pit Required**

- 1) Notwithstanding the requirements of Sentence 7.1.2.1. (1), a minimum of 1 *soil* test pit is adequate for the evaluation of *soil* suitability for an *open discharge system*.

**8.7.3. Open Discharge Systems –Requirements for Materials****8.7.3.1. Gravel**

- 1) If *gravel* is used at the outlet of the *open discharge system* to protect the *soil* from erosion, it does not need to meet any of the specifications in this Standard for *gravel*.



## Part 9 Evaporative and Storage Lagoons

### 9.1.1. Lagoons — Objectives and Design Standards

#### 9.1.1.1. Seepage

- 1) A *lagoon* shall be designed to control seepage
  - a) with a liner, consisting of porous material in which seepage is governed by Darcy's Law, which has a maximum hydraulic conductivity calculated by the following equation:  
 Maximum  $K_T = \frac{C \times T}{T + 2}$   
 where:  
 $K_T$  = maximum hydraulic conductivity of liner in the field, being at least 1 order of magnitude greater than the laboratory value, metres/second  
 $T$  = required or proposed thickness of liner, metres  
 $C = 5.2 \times 10^{-9}$  metres/second;  
 or
  - b) with a flexible polymeric membrane liner having a minimum thickness of 0.5 mm or 500  $\mu\text{m}$  (20 mils), and
    - i) membranes less than 1.5 mm or 1,500  $\mu\text{m}$  (60 mils) thick are covered with a 300 mm (1 ft.) layer of fine grained *soil* on the slopes to prevent liner damage, and
    - ii) PVC and other membranes that are susceptible to weathering when exposed shall be covered with *soil* on both the side slopes and bottom.

#### 9.1.1.2. Evaporation

- 1) A *lagoon* shall be designed to achieve the evaporation of the *wastewater* or *effluent* it receives.
- 2) Notwithstanding Sentence (1), when a *lagoon* is intended to serve only as storage for the winter months or high-flow periods so the accumulated *effluent* can be applied to a *soil-based effluent treatment* and dispersal system during warm weather months, the *lagoon* shall have a storage capacity of not less than 1 year average *wastewater* flow.

#### 9.1.1.3. Dimensions

- 1) A *lagoon* shall be designed to provide<sup>1</sup>
  - a) a *wastewater* depth of not greater than 1.5 m (5 ft.);
  - b) a 600 mm (2 ft.) freeboard height above the design operating depth;
  - c) a *berm* slope not steeper than 1 vertical to 3 horizontal;
  - d) sufficient surface area to evaporate 150% of the expected annual volume of *wastewater* or *effluent* discharged into it, based on mean flow volumes, and the design surface area of the *lagoon* shall<sup>2</sup>
    - i) consider the net evaporation at the system location determined by the average annual precipitation and evaporation rates recorded by the Prairie Farm Rehabilitation Administration as reproduced in Appendix A.2.A. and Appendix A.2.B., and
    - ii) provide adequate storage to hold expected volumes of *wastewater* or *effluent* during winter or other periods of low net evaporation;
  - e) a minimum *berm* width of 1.8 m (6 ft.), as measured at the top of the *berm*; and

- f) a finished elevation of the *berm* that will be above the surrounding *grade*, to prevent the entry of surface run-off water into the *lagoon*.

<sup>1</sup> *Intent: Sentence (1) — Lagoons for private systems built to this Standard are not meant to rely on periodic discharge and must be sized to evaporate all sewage. Annual precipitation and evaporative rates must be considered in the design.*

<sup>2</sup> *Note: Clause (1)(d) — Formulas to calculate the required size of the lagoon are included in Appendix A.2.*

### 9.1.1.4. Influent Receiving Pit

- 1) The *wastewater* or *effluent* shall enter the *lagoon* into a receiving pit that is accessible for periodic cleaning, and the receiving pit shall have the
- capacity to provide storage of accumulating sludge below the elevation of the *wastewater* inlet pipe that is at least the volume of 2 times the average daily flow volume, and
  - inlet pipe entering into it at an elevation that is a minimum of 600 mm (2 ft.) below the bottom of the *lagoon*.<sup>1</sup>

<sup>1</sup> *Intent: Clause (1)(b) — Entering the pipe in this pit should provide a constant 600-mm (2-ft.) cover of water over the pipe that should provide protection from frost. The pit should be approximately 1.8 m x 1.8 m x 1.8 m (6 ft. X 6 ft. X 6 ft.) deep with the pipe entering 1.2 m (4 ft.) above the bottom of the pit.*

### 9.1.1.5. Fencing of Lagoons

- 1) A *lagoon* shall be fenced.<sup>1</sup>

<sup>1</sup> *Intent: Sentence (1) — The fence should be designed to preclude the entrance of children and to discourage trespassing. The fence should also serve to preclude the entrance of livestock. Fences should be located away from the outside toe of the berm to facilitate mowing and maintenance operations. In addition, an access gate should be provided to allow the entry of maintenance equipment, and this gate should be equipped with a lock to prevent the entrance of unauthorized personnel. Signs should be posted to identify the lagoon and advise against trespassing.*

## 9.1.2. Lagoons — Prescriptive Requirements and Installation Standards

### 9.1.2.1. Separation Distances

- 1) A *lagoon* serving a single-family *dwelling* or duplex shall not be located within
- 100 m (330 ft.) of a *water source* or *water well*,
  - 100 m (330 ft.) of a municipal licensed *water well*,
  - 90 m (300 ft.) of a *water course*,
  - 30 m (100 ft.) of a *property* line, and
  - 45 m (150 ft.) of a *building*.
- 2) A *lagoon* serving other than a single-family *dwelling* or duplex shall not be located within
- 100 m (330 ft.) of a *water source* or *water well*,
  - 100 m (330 ft.) of a municipal licensed *water well*,
  - 90 m (300 ft.) of a *water course*,
  - 30 m (100 ft.) of a *property* line,
  - 90 m (300 ft.) of a *building*, and
  - 90 m (300 ft.) of a numbered primary or secondary road.
- 3) All measurements shall be taken from the outside of the *berm*, where the side slope of the *berm* intersects with the natural ground surface.

## Part 10 Privies

### 10.1.1. Privies — Objectives and Design Standards

#### 10.1.1.1. Containment of Waste

- 1) A *privy* shall adequately contain the waste to prevent contamination of water sources.

### 10.1.2. Privies — Prescriptive Requirements and Installation Standards

#### 10.1.2.1. Location of Privies

- 1) Except as provided in Sentence (2), a *privy* shall not be located within
  - a) 15 m (50 ft.) of a *water source* or *water well*;
  - b) 15 m (50 ft.) of a *water course*, except as required by Article 2.1.2.4.;
  - c) 5 m (17 ft.) of a *property* line;
  - d) 6 m (20 ft.) of a store, restaurant, or other place where food is stored, prepared, or consumed; and
  - e) 3.5 m (11.5 ft.) of a single-family *dwelling*.
- 2) Notwithstanding the requirements of Sentence (1), a *privy* equipped with a water-tight *holding tank* to contain the wastes shall not be located within
  - a) 10 m (33 ft.) of a *water source* or *water well*,
  - b) 10 m (33 ft.) of a *water course*,
  - c) 1 m (3.25 ft.) of a *property* line as measured from the tank wall, and
  - d) 1.8 m (6 ft.) of a *property* line as measured from the tank vent termination.
- 3) A *privy* equipped with a watertight *holding tank* to contain the wastes shall be located where it is accessible for removal of the waste by a vacuum truck.

#### 10.1.2.2. Restriction on Receiving Water-carried Wastes

- 1) A *privy* that uses an earthen pit to contain the waste shall not have *wastewater* directed to the pit.<sup>1</sup>

<sup>1</sup> Note: Sentence (1) – See Appendix B-10.1.2.2.(1)

- 2) A *privy* equipped with a watertight *holding tank* to contain wastes may receive *greywater* from outdoor washstands or from a residence.

#### 10.1.2.3. Accessories Required for Water-tight Holding Tanks

- 1) A watertight *holding tank* used to contain the waste from a *privy* shall
  - a) include an opening to facilitate pump out of the tank, and
  - b) include a method of child protection to prevent accidental entry into the tank when used in a location where public access is expected.
- 2) The method of protection referred to in Clause (1)(b) shall
  - a) prevent a spherical object having a *diameter* of 100 mm (4 in.) from passing through, and
  - b) where the method of child protection are bars, they will be aligned to minimize the accumulation of waste material.

**10.1.2.4. Restricted Use of Earthen Pit Privy**

- 1) An earthen pit *privy* may be used only for private use and shall not be used to serve a public or commercial facility.

**10.1.2.5. Earthen Privy Soil Conditions**

- 1) The *soil* in which an earthen *privy* pit is constructed shall
  - a) be *fine sandy loam* or finer textured,
  - b) not include any lenses of *soil* coarser than *fine sandy loam* within the depth of the pit, and
  - c) include *soil* to a depth of at least 600 mm (2 ft.) below the bottom of the pit that is *fine sandy loam* or finer *texture*.
- 2) Below the bottom of the earthen pit there shall be a minimum of 1.2 m (4 ft.) of *soil* to saturated *soil* conditions or bedrock.

**10.1.2.6. Maximum Depth of Earthen Pit Privy**

- 1) The depth of an earthen pit serving a *privy* shall not exceed 1.2 m (4 ft.) below *grade*.

**10.1.2.7. Protection from Surface Water Infiltration**

- 1) The *privy* shall be located where it will not be subject to pooling of surface water runoff.
- 2) An earthen-pit *privy* shall include a *berm* surrounding the pit that is a minimum of 150 mm (6 in.) above the surrounding ground surface to prevent the entry of surface water runoff.
- 3) Openings into a tank used for a *privy* shall be a minimum of 150 mm (6 in.) above the surrounding finished ground surface to prevent surface water runoff from entering the tank.

**10.1.2.8. Venting of Storage Tank**

- 1) The tank of a *privy* accessible to the public shall be ventilated with the termination of the vent above the roof of the *privy* and at least 3.5 m (11.5 ft.) from any adjacent *building* opening.

**10.1.2.9. Privy Structure**

- 1) A sanitary *privy* shall be provided with
  - a) a self-closing door;
  - b) natural lighting;
  - c) seats and covers of non-absorbent, easily cleanable material;
  - d) ventilation of the *privy* enclosure to the outside;
  - e) insect-proof screens on ventilation openings; and
  - f) a toilet paper dispenser.

**10.1.3. Privies — Requirements for Materials****10.1.3.1. Tanks Used under a Privy**

- 1) A tank used to contain the waste from a *privy* shall be *certified* by a accredited testing agency as meeting or exceeding the requirements of CAN/CSA-B66, “Design, Material, and Manufacturing Requirements for Prefabricated Septic Tanks and *Sewage* Holding Tanks,” as amended or replaced from time to time.
- 2) A tank used to contain the waste from a *privy* shall be structurally capable of carrying the load of the *privy structure* and person traffic.





# APPENDIX A

A.1. Pressure Distribution Lateral Pipe System Tables

A.1.A. Number of Orifices in a Distribution Lateral Pipe											
	Orifice Diameter	1/8" (3.2mm)					5/32" (4mm)				
	NPS Pipe Size of Distribution Lateral	3/4" 19mm	1" 25mm	1-1/4" 32mm	1-1/2" 38mm	2" 51mm	3/4" 19mm	1" 25mm	1-1/4" 32mm	1-1/2" 38mm	2" 51mm
Squirt Height, ft.	Distribution Lateral Length, ft.	Maximum Orifices Permitted					Maximum Orifices Permitted				
2 to 4	10	-	-	-	-	-	-	-	-	-	-
	15	-	-	-	-	-	-	-	-	-	-
	20	-	-	-	-	-	-	-	-	-	-
	25	-	-	-	-	-	-	-	-	-	-
	30	-	-	-	-	-	-	-	-	-	-
	35	-	-	-	-	-	-	-	-	-	-
	40	-	-	-	-	-	-	-	-	-	-
	45	-	-	-	-	-	-	-	-	-	-
	50	-	-	-	-	-	-	-	-	-	-
	55	-	-	-	-	-	-	-	-	-	-
	60	-	-	-	-	-	-	-	-	-	-
5 to 9	10	20	20	20	20	20	20	20	20	20	20
	15	26	30	30	30	30	17	30	30	30	30
	20	22	40	40	40	40	14	24	40	40	40
	25	20	37	50	50	50	13	21	48	50	50
	30	18	33	60	60	60	11	20	44	60	60
	35	16	31	70	70	70	11	35	40	60	70
	40	15	29	58	80	80	10	18	37	56	80
	45	14	27	55	82	90	9	17	35	53	90
	50	14	25	52	78	100	-	16	33	50	96
	55	13	24	49	74	110	-	15	32	47	91
	60	12	23	47	70	120	-	15	30	45	87
10 to 15	10	20	20	20	20	20	20	20	20	20	20
	15	26	30	30	30	30	17	30	30	30	30
	20	23	40	40	40	40	15	27	40	40	40
	25	20	38	50	50	50	13	24	50	50	50
	30	18	34	60	60	60	12	22	45	60	60
	35	17	32	65	70	70	11	20	41	62	70
	40	16	29	60	80	80	10	19	39	58	80
	45	15	28	56	85	90	10	18	36	54	90
	50	14	26	53	80	100	-	17	34	51	99
	55	13	25	51	76	110	-	16	33	49	94
	60	13	24	48	72	120	-	15	31	46	89
65	-	23	46	69	130	-	15	30	44	86	

<b>A.1.A. Number of Orifices in a Distribution Lateral Pipe</b>											
	<b>Orifice Diameter</b>	<b>3/16" (4.8mm)</b>					<b>7/32" (5.6mm)</b>				
	<b>NPS Pipe Size of Distribution Lateral</b>	<b>3/4" 19mm</b>	<b>1" 25mm</b>	<b>1-1/4" 32mm</b>	<b>1-1/2" 38mm</b>	<b>2" 51mm</b>	<b>3/4" 19mm</b>	<b>1" 25mm</b>	<b>1-1/4" 32mm</b>	<b>1-1/2" 38mm</b>	<b>2" 51mm</b>
<b>Squirt Height, ft.</b>	<b>Distribution Lateral Length, ft.</b>	<b>Maximum Orifices Permitted</b>					<b>Maximum Orifices Permitted</b>				
<b>2 to 4</b>	10	-	-	-	-	-	10	19	20	20	20
	15	-	-	-	-	-	8	15	30	30	30
	20	-	-	-	-	-	7	13	27	40	40
	25	-	-	-	-	-	6	12	24	36	50
	30	-	-	-	-	-	6	11	22	32	60
	35	-	-	-	-	-	-	10	20	30	57
	40	-	-	-	-	-	-	9	19	28	53
	45	-	-	-	-	-	-	9	17	26	50
	50	-	-	-	-	-	-	-	16	25	47
	55	-	-	-	-	-	-	-	16	23	45
	60	-	-	-	-	-	-	-	15	22	43
65	-	-	-	-	-	-	-	14	21	41	
<b>5 to 9</b>	10	14	20	20	20	20	11	20	20	20	20
	15	12	22	30	30	30	9	16	30	30	30
	20	10	19	38	40	40	7	14	28	40	40
	25	9	16	34	50	50	7	12	25	37	50
	30	8	15	30	46	60	6	11	22	34	60
	35	7	14	28	42	70	-	10	21	31	59
	40	-	13	26	39	75	-	10	19	29	55
	45	-	12	25	37	71	-	9	18	27	52
	50	-	11	23	35	67	-	-	17	26	49
	55	-	11	22	33	63	-	-	16	24	47
	60	-	10	21	31	60	-	-	16	23	44
65	-	10	20	30	58	-	-	15	22	43	
<b>10 to 15</b>	10	15	20	20	20	20	11	20	20	20	20
	15	12	22	30	30	30	9	16	30	30	30
	20	10	19	39	40	40	8	14	29	40	40
	25	9	17	35	50	50	7	13	25	38	50
	30	8	15	31	47	60	6	11	23	35	60
	35	8	14	29	43	70	-	10	21	32	61
	40	-	13	27	40	77	-	10	20	30	57
	45	-	12	25	38	73	-	9	19	28	53
	50	-	12	24	36	69	-	9	18	26	50
	55	-	11	23	34	65	-	-	17	25	48
	60	-	-	22	32	62	-	-	16	24	46
65	-	-	21	31	60	-	-	15	23	44	

<b>A.1.A. Number of Orifices in a Distribution Lateral Pipe</b>											
	<b>Orifice Diameter</b>	<b>1/4" (6.4mm)</b>					<b>9/32" (7.1mm)</b>				
	<b>NPS Pipe Size of Distribution Lateral</b>	3/4" 19mm	1" 25mm	1-1/4" 32mm	1-1/2" 38mm	2" 51mm	3/4" 19mm	1" 25mm	1-1/4" 32mm	1-1/2" 38mm	2" 51mm
<b>Squirt Height, ft.</b>	<b>Distribution Lateral Length, ft.</b>	<b>Maximum Orifices Permitted</b>					<b>Maximum Orifices Permitted</b>				
<b>2 to 4</b>	10	8	15	20	20	20	6	12	20	20	20
	15	6	12	24	30	30	5	9	19	28	30
	20	6	10	21	31	40	4	8	16	24	40
	25	5	9	18	27	50	-	7	15	22	42
	30	-	8	17	25	48	-	7	13	20	38
	35	-	8	15	23	44	-	-	12	18	35
	40	-	-	14	21	41	-	-	11	17	32
	45	-	-	13	20	38	-	-	11	16	30
	50	-	-	13	19	36	-	-	10	15	29
	55	-	-	12	18	34	-	-	-	14	27
	60	-	-	12	17	33	-	-	-	14	26
65	-	-	-	16	31	-	-	-	13	25	
<b>5 to 9</b>	10	8	15	20	20	20	7	12	20	20	20
	15	7	12	25	30	30	5	10	20	30	30
	20	6	11	21	32	40	5	8	17	25	40
	25	5	9	19	28	50	-	7	15	22	43
	30	-	9	17	26	49	-	7	14	20	39
	35	-	8	16	24	46	-	-	13	19	36
	40	-	-	15	22	42	-	-	12	18	34
	45	-	-	14	21	40	-	-	11	16	32
	50	-	-	13	20	38	-	-	10	16	30
	55	-	-	13	19	36	-	-	-	15	28
	60	-	-	12	18	34	-	-	-	14	27
65	-	-	-	17	33	-	-	-	14	26	
<b>10 to 15</b>	10	8	16	20	20	20	7	12	20	20	20
	15	7	13	26	30	30	5	10	20	30	30
	20	6	11	22	33	40	5	9	17	26	40
	25	5	10	20	29	50	-	8	16	23	44
	30	-	9	18	26	51	-	7	14	21	40
	35	-	8	16	24	47	-	-	13	19	37
	40	-	8	15	23	44	-	-	12	18	35
	45	-	-	14	21	41	-	-	11	17	32
	50	-	-	14	20	39	-	-	11	16	31
	55	-	-	13	19	37	-	-	-	15	29
	60	-	-	12	18	35	-	-	-	15	28
65	-	-	-	18	34	-	-	-	14	27	

<b>A.1.A. Number of Orifices in a Distribution Lateral Pipe</b>						
	<b>Orifice Diameter</b>	<b>5/16" (7.9mm)</b>				
	<b>NPS Pipe Size of Distribution Lateral</b>	<b>3/4" (19 mm)</b>	<b>1" (25 mm)</b>	<b>1-1/4" (32 mm)</b>	<b>1-1/2" (38 mm)</b>	<b>2" (51 mm)</b>
<b>Squirt Height, ft.</b>	<b>Distribution Lateral Length, ft.</b>	<b>Maximum Orifices Permitted</b>				
<b>2 to 4</b>	10	5	9	19	20	20
	15	4	8	16	23	30
	20	4	7	13	20	38
	25	-	6	12	18	34
	30	-	-	11	16	31
	35	-	-	10	15	28
	40	-	-	9	14	26
	45	-	-	9	13	25
	50	-	-	-	12	23
	55	-	-	-	12	22
	60	-	-	-	-	21
<b>5 to 9</b>	10	5	10	20	20	20
	15	4	8	16	24	30
	20	4	7	14	21	39
	25	-	6	12	18	35
	30	-	6	11	17	32
	35	-	-	10	15	29
	40	-	-	10	14	27
	45	-	-	9	13	26
	50	-	-	-	13	24
	55	-	-	-	12	23
	60	-	-	-	-	22
<b>10 to 15</b>	10	5	10	20	20	20
	15	4	8	17	25	30
	20	4	7	14	21	40
	25	-	6	13	19	36
	30	-	6	11	17	33
	35	-	-	11	16	30
	40	-	-	10	15	28
	45	-	-	9	14	26
	50	-	-	-	13	25
	55	-	-	-	12	24
	60	-	-	-	12	23
65	-	-	-	-	22	

## A.1.B. Orifice Discharge Rates

A.1.B.1. Orifice Discharge Rate in Imperial Gallons per Minute									
Pressure Head, ft.	Orifice Diameter, Inches								
	1/8	5/32	3/16	7/32	1/4	9/32	5/16	11/32	3/8
2.0	-	-	-	0.66	0.87	1.10	1.36	1.64	1.95
2.5	-	-	-	0.74	0.97	1.23	1.52	1.83	2.18
3.0	-	-	-	0.81	1.06	1.35	1.66	2.01	2.39
3.5	-	-	-	0.88	1.15	1.45	1.79	2.17	2.58
4.0	-	-	-	0.94	1.23	1.55	1.92	2.32	2.76
4.5	-	-	-	1.00	1.30	1.65	2.03	2.46	2.93
5.0	0.34	0.54	0.77	1.05	1.37	1.74	2.14	2.59	3.09
5.5	0.36	0.56	0.81	1.10	1.44	1.82	2.25	2.72	3.24
6.0	0.38	0.59	0.85	1.15	1.50	1.90	2.35	2.84	3.38
6.5	0.39	0.61	0.88	1.20	1.56	1.98	2.45	2.96	3.52
7.0	0.41	0.63	0.91	1.24	1.62	2.06	2.54	3.07	3.65
7.5	0.42	0.66	0.95	1.29	1.68	2.13	2.63	3.18	3.78
8.0	0.43	0.68	0.98	1.33	1.74	2.20	2.71	3.28	3.91
8.5	0.45	0.70	1.01	1.37	1.79	2.26	2.80	3.38	4.03
9.0	0.46	0.72	1.04	1.41	1.84	2.33	2.88	3.48	4.14
9.5	0.47	0.74	1.06	1.45	1.89	2.39	2.96	3.58	4.26
10.0	0.49	0.76	1.09	1.49	1.94	2.46	3.03	3.67	4.37
10.5	0.50	0.78	1.12	1.52	1.99	2.52	3.11	3.76	4.48
11.0	0.51	0.80	1.15	1.56	2.04	2.58	3.18	3.85	4.58
11.5	0.52	0.81	1.17	1.59	2.08	2.63	3.25	3.94	4.68
12.0	0.53	0.83	1.20	1.63	2.13	2.69	3.32	4.02	4.78
12.5	0.54	0.85	1.22	1.66	2.17	2.75	3.39	4.10	4.88
13.0	0.55	0.86	1.24	1.69	2.21	2.80	3.46	4.18	4.98
13.5	0.56	0.88	1.27	1.73	2.26	2.85	3.52	4.26	5.07
14.0	0.57	0.90	1.29	1.76	2.30	2.91	3.59	4.34	5.17
14.5	0.58	0.91	1.31	1.79	2.34	2.96	3.65	4.42	5.26
15.0	0.59	0.93	1.34	1.82	2.38	3.01	3.71	4.49	5.35
16.0	0.61	0.96	1.38	1.88	2.46	3.11	3.84	4.64	5.52
18.0	0.65	1.02	1.46	1.99	2.60	3.30	4.07	4.92	5.86
20.0	0.69	1.07	1.54	2.10	2.75	3.47	4.29	5.19	6.18
22.0	0.72	1.12	1.62	2.20	2.88	3.64	4.50	5.44	6.48
24.0	0.75	1.17	1.69	2.30	3.01	3.81	4.70	5.69	6.77
26.0	0.78	1.22	1.76	2.40	3.13	3.96	4.86	5.92	7.04
28.0	0.81	1.27	1.83	2.49	3.25	4.11	5.08	6.14	7.31
30.0	0.84	1.31	1.89	2.57	3.36	4.26	5.25	6.36	7.56

<b>A.1.B.1. Orifice Discharge Rate in Imperial Gallons per Minute (continued)</b>									
Pressure Head, ft.	Orifice Diameter, Inches								
	1/8	5/32	3/16	7/32	1/4	9/32	5/16	11/32	3/8
32.0	0.87	1.36	1.95	2.66	3.47	4.39	5.43	6.56	7.81
34.0	0.89	1.40	2.01	2.74	3.58	4.53	5.59	6.77	8.05
36.0	0.92	1.44	2.07	2.82	3.68	4.66	5.75	6.96	8.29
38.0	0.95	1.48	2.13	2.90	3.78	4.79	5.91	7.15	8.51
40.0	0.97	1.52	2.18	2.97	3.88	4.91	6.07	7.34	8.73
42.0	0.99	1.55	2.24	3.05	3.98	5.03	6.22	7.52	8.95
44.0	1.02	1.59	2.29	3.12	4.07	5.15	6.36	7.70	9.16
46.0	1.04	1.63	2.34	3.19	4.16	5.27	6.50	7.87	9.37
48.0	1.06	1.66	2.39	3.26	4.25	5.38	6.64	8.04	9.57
50.0	1.09	1.70	2.44	3.32	4.34	5.49	6.78	8.21	9.77

based on  $q = 16.37Cd^2h^{1/2}$   
 where  $q$  = Imperial gallons per minute flow rate  
 $C$  = coefficient of discharge (0.60)  
 $d$  = diameter in inches  
 $h$  = pressure head in feet

Use A Minimum 2.0 ft. (600 mm) Of Pressure Head  
 Note: Some pump manufacturers rate pump capacities in US gallons.  
 Pump ratings in US gallons must be converted to Imperial gallons.  
 US Gallons x 0.83 = Imperial Gallons

*Note: This table is used to determine the flow rate of an orifice size at a selected pressure head. To determine the total flow, multiply the flow rate for an orifice by the number of orifices in the distribution lateral pipes.*

A.1.B.2. Orifice Discharge Rate in Litres per Minute									
Pressure Head, mm	Orifice Diameter, mm (in.)								
	3.22 mm (1/8")	4.0 mm (5/32")	4.8 mm (3/16")	5.6 mm (7/32")	6.4 mm (1/4")	7.1 mm (9/32")	7.9 mm (5/16")	8.7 mm (11/32")	9.5 mm (3/8")
600	-	-	-	3.02	3.95	4.99	6.17	7.46	8.88
750	-	-	-	3.38	4.41	5.58	6.89	8.34	9.93
900	-	-	-	3.70	4.83	6.12	7.55	9.14	10.87
1050	-	-	-	4.00	5.22	6.61	8.16	9.87	11.75
1200	-	-	-	4.27	5.58	7.06	8.72	10.55	12.56
1350	-	-	-	4.53	5.92	7.49	9.25	11.19	13.32
1500	1.56	2.44	3.51	4.78	6.24	7.90	9.75	11.80	14.04
1650	1.64	2.56	3.68	5.01	6.54	8.28	10.23	12.37	14.72
1800	1.71	2.67	3.84	5.23	6.84	8.65	10.68	12.92	15.38
1950	1.78	2.78	4.00	5.45	7.11	9.00	11.12	13.45	16.01
2100	1.85	2.88	4.15	5.65	7.38	9.34	11.54	13.96	16.61
2250	1.91	2.99	4.30	5.85	7.64	9.67	11.94	14.45	17.19
2400	1.97	3.08	4.44	6.04	7.89	9.99	12.33	14.92	17.76
2550	2.03	3.18	4.58	6.23	8.14	10.30	12.71	15.38	18.30
2700	2.09	3.27	4.71	6.41	8.37	10.60	13.08	15.83	18.84
2850	2.15	3.36	4.84	6.58	8.60	10.89	13.44	16.26	19.35
3000	2.21	3.45	4.96	6.76	8.82	11.17	13.79	16.68	19.85
3150	2.26	3.53	5.09	6.92	9.04	11.44	14.13	17.10	20.34
3300	2.31	3.62	5.21	7.09	9.25	11.71	14.46	17.50	20.82
3450	2.37	3.70	5.32	7.25	9.46	11.98	14.79	17.89	21.29
3600	2.42	3.78	5.44	7.40	9.67	12.23	15.10	18.28	21.75
3750	2.47	3.85	5.55	7.55	9.87	12.49	15.42	18.65	22.20
3900	2.52	3.93	5.66	7.70	10.06	12.73	15.72	19.02	22.64
4050	2.56	4.01	5.77	7.85	10.25	12.98	16.02	19.38	23.07
4200	2.61	4.08	5.87	7.99	10.44	13.21	16.31	19.74	23.49
4350	2.66	4.15	5.98	8.14	10.63	13.45	16.60	20.09	23.91
4500	2.70	4.22	6.08	8.27	10.81	13.68	16.89	20.43	24.32
4650	2.75	4.29	6.18	8.41	10.99	13.90	17.17	20.77	24.72
4800	2.79	4.36	6.28	8.55	11.16	14.13	17.44	21.10	25.11
4950	2.83	4.43	6.38	8.68	11.33	14.35	17.71	21.43	25.50
5100	2.88	4.49	6.47	8.81	11.51	14.56	17.98	21.75	25.89
5250	2.92	4.56	6.57	8.94	11.67	14.77	18.24	22.07	26.26
5400	2.96	4.62	6.66	9.06	11.84	14.98	18.50	22.38	26.64
5550	3.00	4.69	6.75	9.19	12.00	15.19	18.75	22.69	27.00
5700	3.04	4.75	6.84	9.31	12.16	15.39	19.00	23.00	27.37
5850	3.08	4.81	6.93	9.43	12.32	15.60	19.25	23.30	27.72
6000	3.12	4.87	7.02	9.55	12.48	15.79	19.50	23.59	28.08
6150	3.16	4.94	7.11	9.67	12.63	15.99	19.74	23.89	28.43
6300	3.20	5.00	7.19	9.79	12.79	16.18	19.98	24.18	28.77
6450	3.23	5.05	7.28	9.91	12.94	16.38	20.22	24.46	29.11
6600	3.27	5.11	7.36	10.02	13.09	16.56	20.45	24.74	29.45
6750	3.31	5.17	7.45	10.13	13.24	16.75	20.68	25.02	29.78
6900	3.35	5.23	7.53	10.25	13.38	16.94	20.91	25.30	30.11
7050	3.38	5.28	7.61	10.36	13.53	17.12	21.14	25.57	30.44
7200	3.42	5.34	7.69	10.47	13.67	17.30	21.36	25.85	30.76
7350	3.45	5.40	7.77	10.57	13.81	17.48	21.58	26.11	31.08
7500	3.49	5.45	7.85	10.68	13.95	17.66	21.80	26.38	31.39
7650	3.52	5.50	7.93	10.79	14.09	17.83	22.02	26.64	31.70
7800	3.56	5.56	8.00	10.89	14.23	18.01	22.23	26.90	32.01



A.1.B.2. Orifice Discharge Rate in Litres per Minute (continued)									
Pressure Head, mm	Orifice Diameter, mm (in.)								
	3.22 mm (1/8")	4.0 mm (5/32")	4.8 mm (3/16")	5.6 mm (7/32")	6.4 mm (1/4")	7.1 mm (9/32")	7.9 mm (5/16")	8.7 mm (11/32")	9.5 mm (3/8")
7950	3.59	5.61	8.08	11.00	14.36	18.18	22.44	27.16	32.32
8100	3.62	5.66	8.16	11.10	14.50	18.35	22.66	27.41	32.62
8250	3.66	5.72	8.23	11.20	14.63	18.52	22.86	27.67	32.92
8400	3.69	5.77	8.31	11.30	14.77	18.69	23.07	27.92	33.22
8550	3.72	5.82	8.38	11.41	14.90	18.85	23.28	28.16	33.52
8700	3.76	5.87	8.45	11.50	15.03	19.02	23.48	28.41	33.81
8850	3.79	5.92	8.53	11.60	15.16	19.18	23.68	28.65	34.10
9000	3.82	5.97	8.60	11.70	15.28	19.34	23.88	28.90	34.39
9150	3.85	6.02	8.67	11.80	15.41	19.50	24.08	29.14	34.67
9300	3.88	6.07	8.74	11.90	15.54	19.66	24.28	29.37	34.96
9450	3.92	6.12	8.81	11.99	15.66	19.82	24.47	29.61	35.24
9600	3.95	6.19	8.88	12.09	15.78	19.98	24.66	29.84	35.52
9750	3.98	6.21	8.95	12.18	15.91	20.13	24.86	30.08	35.79
9900	4.01	6.26	9.02	12.27	16.03	20.29	25.05	30.31	36.07
10050	4.04	6.31	9.08	12.37	16.15	20.44	25.24	30.53	36.34
10200	4.07	6.36	9.15	12.46	16.27	20.59	25.42	30.76	36.61
10350	4.10	6.40	9.22	12.55	16.39	20.74	25.61	30.99	36.88
10500	4.13	6.45	9.29	12.64	16.51	20.89	25.79	31.21	37.14
10650	4.16	6.49	9.35	12.73	16.63	21.04	25.98	31.43	37.41
10800	4.19	6.54	9.42	12.82	16.74	21.19	26.16	31.65	37.67
10950	4.21	6.59	9.48	12.91	16.86	21.34	26.34	31.87	37.93
11100	4.24	6.63	9.55	13.00	16.97	21.48	26.52	32.09	38.19
11250	4.27	6.67	9.61	13.08	17.09	21.63	26.70	32.31	38.45
11400	4.30	6.72	9.68	13.17	17.20	21.77	26.88	32.52	38.70
11550	4.33	6.76	9.74	13.26	17.31	21.91	27.05	32.73	38.96
11700	4.36	6.81	9.80	13.34	17.43	22.05	27.23	32.95	39.21
11850	4.38	6.85	9.86	13.43	17.54	22.20	27.40	33.16	39.46
12000	4.41	6.89	9.93	13.51	17.65	22.34	27.58	33.37	39.71
12150	4.44	6.94	9.99	13.60	17.76	22.48	27.75	33.57	39.96
12300	4.47	6.98	10.05	13.68	17.87	22.61	27.92	33.78	40.20
12450	4.49	7.02	10.11	13.76	17.98	22.75	28.09	33.99	40.45
12600	4.52	7.06	10.17	13.85	18.08	22.89	28.26	34.19	40.69
12750	4.55	7.11	10.23	13.93	18.19	23.02	28.42	34.39	40.93
12900	4.57	7.15	10.29	14.01	18.30	23.16	28.59	34.59	41.17
13050	4.60	7.19	10.35	14.09	18.40	23.29	28.76	34.80	41.41
13200	4.63	7.23	10.41	14.17	18.51	23.43	28.92	34.99	41.65
13350	4.65	7.27	10.47	14.25	18.61	23.56	29.08	35.19	41.88
13500	4.68	7.31	10.53	14.33	18.72	23.69	29.25	35.39	42.12
13650	4.71	7.35	10.59	14.41	18.82	23.80	29.41	35.59	42.36
13800	4.73	7.39	10.65	14.49	18.93	23.95	29.57	35.78	42.59
13950	4.76	7.43	10.70	14.57	19.03	24.08	29.73	35.97	42.81
14100	4.78	7.47	10.76	14.65	19.13	24.21	29.89	36.17	43.04
14250	4.81	7.51	10.82	14.72	19.23	24.34	30.05	36.36	43.27
14400	4.83	7.55	10.87	14.80	19.33	24.47	30.21	36.55	43.50
14550	4.86	7.59	10.93	14.88	19.43	24.59	30.36	36.74	43.73
14700	4.88	7.63	10.99	14.95	19.53	24.72	30.52	36.93	43.95
14850	4.91	7.67	11.04	15.03	19.63	24.85	30.68	37.12	44.17
15000	4.93	7.71	11.10	15.11	19.73	24.97	30.83	37.30	44.40

Note: This table is used to determine the flow rate of an orifice size at a selected pressure head. To determine the total flow, multiply the flow rate for an orifice by the number of orifices in the distribution lateral pipes.

A.1.C.1. Friction Loss in PVC Schedule 40 Pipe – Imperial & U.S. Gallons

A.1.C.1 Friction Loss in Feet Pressure Head per 100 Feet in Schedule 40 PVC Pipe (C=150)													
Flow in Imp gpm	Nominal Pipe Diameter (in.)						Flow in US gpm	Nominal Pipe Diameter (in.)					
	3/4	1	1 1/4	1 1/2	2	3		3/4	1	1 1/4	1 1/2	2	3
1	0.35	0.11	0.03	0.01	0.00	0.00	1	0.25	0.08	0.02	0.01	0.00	0.00
2	1.27	0.39	0.10	0.05	0.01	0.00	2	0.91	0.28	0.07	0.03	0.01	0.00
3	<b>2.69</b>	0.83	0.22	0.10	0.03	0.00	3	1.92	0.59	0.16	0.07	0.02	0.00
4	<b>4.59</b>	1.42	0.37	0.18	0.05	0.01	4	<b>3.27</b>	1.01	0.27	0.13	0.04	0.01
5	<b>6.93</b>	<b>2.14</b>	0.56	0.27	0.08	0.01	5	<b>4.95</b>	1.53	0.40	0.19	0.06	0.01
6	<b>9.71</b>	<b>3.00</b>	0.79	0.37	0.11	0.02	6	<b>6.93</b>	<b>2.14</b>	0.56	0.27	0.08	0.01
7	12.92	<b>3.99</b>	1.05	0.50	0.15	0.02	7	<b>9.22</b>	<b>2.85</b>	0.75	0.35	0.11	0.02
8	16.54	<b>5.11</b>	<b>1.35</b>	0.64	0.19	0.03	8	<b>11.80</b>	<b>3.65</b>	0.96	0.45	0.13	0.02
9	20.56	<b>6.35</b>	<b>1.67</b>	0.79	0.23	0.03	9	14.67	<b>4.53</b>	1.19	0.56	0.17	0.02
10	24.99	<b>7.72</b>	<b>2.03</b>	0.96	0.28	0.04	10	17.83	<b>5.51</b>	<b>1.45</b>	0.69	0.20	0.03
11	29.80	<b>9.21</b>	<b>2.42</b>	<b>1.15</b>	0.34	0.05	11	21.27	<b>6.57</b>	<b>1.73</b>	0.82	0.24	0.04
12	35.01	10.82	<b>2.85</b>	<b>1.35</b>	0.40	0.06	12	24.99	<b>7.72</b>	<b>2.03</b>	0.96	0.28	0.04
13	40.60	12.54	<b>3.30</b>	<b>1.56</b>	0.46	0.07	13	28.97	<b>8.95</b>	<b>2.36</b>	<b>1.11</b>	0.33	0.05
14		14.38	<b>3.79</b>	<b>1.79</b>	0.53	0.08	14	33.23	10.27	<b>2.70</b>	<b>1.28</b>	0.38	0.06
15		16.34	<b>4.30</b>	<b>2.03</b>	0.60	0.09	15	37.76	11.66	<b>3.07</b>	<b>1.45</b>	0.43	0.06
16		18.42	<b>4.85</b>	<b>2.29</b>	0.68	0.10	16	42.54	13.14	<b>3.46</b>	<b>1.63</b>	0.48	0.07
17		20.60	<b>5.42</b>	<b>2.56</b>	0.76	0.11	17		14.70	<b>3.87</b>	<b>1.83</b>	0.54	0.08
18		22.90	<b>6.03</b>	<b>2.85</b>	<b>0.84</b>	0.12	18		16.34	<b>4.30</b>	<b>2.03</b>	0.60	0.09
19		25.31	<b>6.66</b>	<b>3.15</b>	<b>0.93</b>	0.14	19		18.06	<b>4.76</b>	<b>2.25</b>	0.67	0.10
20		27.83	7.33	<b>3.46</b>	<b>1.03</b>	0.15	20		19.86	<b>5.23</b>	<b>2.47</b>	0.73	0.11
25		42.05	11.07	<b>5.23</b>	<b>1.55</b>	0.23	25		30.01	7.90	<b>3.73</b>	<b>1.11</b>	0.16
30			15.51	7.33	<b>2.17</b>	0.32	30		42.05	11.07	<b>5.23</b>	<b>1.55</b>	0.23
35			20.63	9.75	<b>2.89</b>	0.42	35			14.73	6.96	<b>2.06</b>	0.30
40			26.42	12.48	<b>3.70</b>	<b>0.54</b>	40			18.85	8.91	<b>2.64</b>	0.39
45			32.85	15.52	4.60	<b>0.67</b>	45			23.44	11.07	<b>3.28</b>	0.48
50			39.92	18.85	5.59	<b>0.82</b>	50			28.49	13.46	<b>3.99</b>	<b>0.58</b>
55				22.49	6.67	<b>0.98</b>	55			33.98	16.05	4.76	<b>0.70</b>
60				26.42	7.83	<b>1.15</b>	60			39.92	18.85	5.59	<b>0.82</b>
65				30.63	9.08	<b>1.33</b>	65				21.86	6.48	<b>0.95</b>
70				35.14	10.42	<b>1.53</b>	70				25.08	7.44	<b>1.09</b>
75				39.92	11.84	<b>1.73</b>	75				28.49	8.45	<b>1.24</b>
80					13.34	<b>1.95</b>	80				32.10	9.52	<b>1.39</b>
85					14.92	<b>2.18</b>	85				35.91	10.65	<b>1.56</b>
90					16.58	<b>2.43</b>	90				39.92	11.84	<b>1.73</b>
95					18.33	<b>2.68</b>	95					13.08	<b>1.91</b>
100					20.15	2.95	100					14.38	<b>2.11</b>
125					30.45	4.46	125					21.73	3.18
150					42.67	6.25	150					30.45	4.46
175						8.31	175					40.50	5.93
200						10.64	200						7.59
250						16.07	250						11.47
300						22.52	300						16.07

Note: The values contained within the bolded lines represent a flow velocity within the desired range of 2 to 5 ft. per second. Flow velocity should exceed 2 ft. per second to achieve required scouring of deposits and growth on pipe walls cause by the effluent. Flow velocity over 5 ft. per second should be used cautiously due to excessive pressure being created from sudden flow stops caused by quick closing valves or shock occurring from trapped air in portions of the effluent lines.

## A.1.C.2. Friction Loss in PVC Schedule 40 Pipe - Metric

<b>A.1.C.2. Friction Loss in mm Pressure Head per 30.5 Metres in Schedule 40 PVC Pipe (C=150)</b>						
Flow in L/min.	Nominal Pipe Diameter (in.)					
	3/4	1	1 1/4	1 1/2	2	3
5	128	40	10	5	1	0
10	462	143	38	18	5	1
15	979	302	80	38	11	2
20	1667	515	136	64	19	3
25	2519	778	205	97	29	4
30	3530	1090	287	136	40	6
35	4695	1450	382	180	53	8
40	6010	1857	489	231	68	10
45	7473	2309	608	287	85	12
50	9082	2806	739	349	103	15
55	10833	3347	881	416	123	18
60	12725	3931	1035	489	145	21
65	14756	4559	1200	567	168	25
70		5228	1377	650	193	28
75		5940	1564	739	219	32
80		6694	1763	833	247	36
85		7488	1972	931	276	40
90		8323	2192	1035	307	45
95		9199	2422	1144	339	50
100		10114	2663	1258	373	55
120		14172	3732	1763	523	77
140			4963	2344	695	102
160			6354	3001	890	130
180			7901	3732	1107	162
200			9602	4535	1345	197
220			11453	5410	1604	235
240				6355	1884	276
260				7369	2185	320
280				8452	2506	367
300				9603	2847	417
320				10820	3208	470
340					3589	525
360					3989	584
380					4409	645
400					4848	710
450					6028	882
500					7325	1072
550					8738	1279
600						1502
700						1998
800						2558
900						3181

Note: The values contained within the bolded lines represent a flow velocity within the desired range of 2 to 5 ft. per second. Flow velocity should exceed 2 ft. per second to achieve required scouring of deposits on pipe walls. Flow velocity over 5 ft. per second should be used cautiously due to excessive pressure being created from sudden flow stops caused by quick closing valves.

**A.1.C.3. Friction Loss in Polyethylene Pipe – Gallons**

<b>A.1.C.3. Friction Loss in Feet Pressure Head per 100 Feet in Polyethylene Pipe, "Carlton" (C=147)</b>													
Flow in Imp gpm	Nominal Pipe Diameter (in.)						Flow in US gpm	Nominal Pipe Diameter (in.)					
	3/4	1	1 1/4	1 1/2	2	3		3/4	1	1 1/4	1 1/2	2	3
1	0.37	0.11	0.03	0.01	0.00	0.00	1	0.26	0.08	0.02	0.01	0.00	0.00
2	1.32	0.41	0.11	0.05	0.02	0.00	2	0.94	0.29	0.08	0.04	0.01	0.00
3	2.80	0.86	0.23	0.11	0.03	0.00	3	2.00	0.62	0.16	0.08	0.02	0.00
4	4.76	1.47	0.39	0.18	0.05	0.01	4	3.40	1.05	0.28	0.13	0.04	0.01
5	7.19	2.22	0.59	0.28	0.08	0.01	5	5.13	1.59	0.42	0.20	0.06	0.01
6	10.08	3.11	0.82	0.39	0.11	0.02	6	7.19	2.22	0.59	0.28	0.08	0.01
7	13.41	4.14	1.09	0.52	0.15	0.02	7	9.57	2.96	0.78	0.37	0.11	0.02
8	17.16	5.30	1.40	0.66	0.20	0.03	8	12.25	3.78	1.00	0.47	0.14	0.02
9	21.34	6.59	1.74	0.82	0.24	0.04	9	15.23	4.71	1.24	0.59	0.17	0.03
10	25.94	8.01	2.11	1.00	0.30	0.04	10	18.51	5.72	1.51	0.71	0.21	0.03
11	30.94	9.56	2.52	1.19	0.35	0.05	11	22.08	6.82	1.80	0.85	0.25	0.04
12	36.34	11.23	2.96	1.40	0.41	0.06	12	25.94	8.01	2.11	1.00	0.30	0.04
13	42.14	13.02	3.43	1.62	0.48	0.07	13	30.08	9.29	2.45	1.16	0.34	0.05
14		14.93	3.93	1.86	0.55	0.08	14	34.50	10.66	2.81	1.33	0.39	0.06
15		16.97	4.47	2.11	0.63	0.09	15	39.19	12.11	3.19	1.51	0.45	0.07
16		19.12	5.03	2.38	0.71	0.10	16	44.16	13.64	3.59	1.70	0.50	0.07
17		21.39	5.63	2.66	0.79	0.12	17		15.26	4.02	1.90	0.56	0.08
18		23.77	6.26	2.96	0.88	0.13	18		16.97	4.47	2.11	0.63	0.09
19		26.27	6.92	3.27	0.97	0.14	19		18.75	4.94	2.33	0.69	0.10
20		28.89	7.61	3.59	1.07	0.16	20		20.62	5.43	2.56	0.76	0.11
25		43.65	11.49	5.43	1.61	0.24	25		31.15	8.20	3.87	1.15	0.17
30			16.11	7.61	2.26	0.33	30		43.65	11.49	5.43	1.61	0.24
35			21.42	10.12	3.00	0.44	35			15.29	7.22	2.14	0.31
40			27.42	12.95	3.84	0.56	40			19.57	9.24	2.74	0.40
45			34.10	16.11	4.78	0.70	45			24.34	11.50	3.41	0.50
50			41.44	19.57	5.80	0.85	50			29.57	13.97	4.14	0.61
55				23.35	6.92	1.01	55			35.28	16.66	4.94	0.72
60				27.42	8.13	1.19	60			41.44	19.57	5.80	0.85
65				31.80	9.43	1.38	65				22.70	6.73	0.99
70				36.47	10.81	1.58	70				26.03	7.72	1.13
75				41.44	12.29	1.80	75				29.58	8.77	1.28
80					13.85	2.03	80				33.33	9.88	1.45
85					15.49	2.27	85				37.28	11.05	1.62
90					17.22	2.52	90				41.44	12.29	1.80
95					19.03	2.79	95					13.58	1.99
100					20.92	3.06	100					14.93	2.19
125					31.61	4.63	125					22.56	3.30
150					44.29	6.48	150					31.61	4.63
175						8.62	175					42.05	6.15
200						11.04	200						7.88
250						16.68	250						11.91
300						23.37	300						16.68

## A.1.C.4. Friction Loss in Polyethylene Pipe – Metric

<b>A.1.C.4. Friction Loss in mm Pressure Head per 30.5 Metres in Polyethylene Pipe, “Carbon” (C=147)</b>						
Flow in L/min.	Nominal Pipe Diameter (in.)					
	3/4	1	1 1/4	1 1/2	2	3
5	133	41	11	5	2	0
10	480	148	39	18	5	1
15	1016	314	83	39	12	2
20	1731	535	141	67	20	3
25	2615	808	213	100	30	4
30	3664	1132	298	141	42	6
35	4873	1506	396	187	56	8
40	6239	1927	508	240	71	10
45	7758	2397	631	298	88	13
50	9428	2912	767	362	107	16
55	11246	3474	915	432	128	19
60	13210	4081	1075	508	151	22
65	15318	4732	1246	589	175	26
70		5428	1429	675	200	29
75		6166	1624	767	227	33
80		6948	1830	864	256	38
85		7773	2047	967	287	42
90		8640	2275	1075	319	47
95		9549	2515	1188	352	52
100		10500	2765	1306	387	57
120		14711	3874	1830	543	79
140			5152	2434	722	106
160			6596	3116	924	135
180			8202	3874	1149	168
200			9967	4708	1396	204
220			11889	5616	1665	244
240				6597	1956	286
260				7650	2268	332
280				8774	2601	381
300				9968	2956	433
320				11232	3330	488
340					3726	545
360					4141	606
380					4577	670
400					5032	737
450					6258	916
500					7604	1113
550					9071	1328
600						1560
700						2074
800						2656
900						3302

Note: The values contained within the bolded lines represent a flow velocity within the desired range of 2 to 5 ft. per second. Flow velocity should exceed 2 ft. per second to achieve required scouring of deposits on pipe walls. Flow velocity over 5 ft. per second should be used cautiously due to excessive pressure being created from sudden flow stops caused by quick closing valves.

**A.1.C.5. Friction Loss Equivalent Lengths for Fittings – Polyethylene Pipe**

A.1.C.5. Friction Loss Equivalent Lengths for Polyethylene Piping Insert Fittings						
Expressed in Approximate Length of Straight Pipe						
Pipe Size (in.)	Male/Female Pipe Adapters		Couplings and Tee Fittings on the Run		Elbows and Tee Fittings Run to Branch	
	Feet	Metres	Feet	Metres	Feet	Metres
1/2	1	0.3	0.5	0.15	3	0.91
3/4	1.5	0.46	0.75	0.23	4.3	1.31
1	2	0.61	1	0.3	6	1.83
1 1/4	2.7	0.82	1.3	0.4	8.6	2.62
1 1/2	3.4	1.04	1.6	0.49	10.5	3.2
2	4.4	1.34	2	0.61	13.2	4.02
3	6.2	1.89	2.9	0.88	17	5.18

**A.1.C.6. Friction Loss Equivalent Lengths of Pipe for Fittings – Schedule 40 PVC Pipe**

A.1.C.6. Friction Loss Equivalent Lengths of Pipe for Fittings – PVC Sched 40 in Metric												
Expressed in Approximate Length of Straight Pipe												
Pipe Size mm (inches)	Male/Female Pipe Adapters		Couplings and Tee Fittings on the Run		90° Elbows		Tee Fittings Run to Branch		45° Elbows		Gate Valves	
	Feet	Metres	Feet	Metres	Feet	Metres	Feet	Metres	Feet	Metres	Feet	Metres
12.8 mm (½")	1	.3	1	.3	1.5	.46	4	1.21	.8	.24	.3	.09
19 mm (¾")	1.5	.46	1.4	.43	2	.61	5	1.57	1.1	.33	.4	.12
25 mm (1")	2	.61	1.7	.51	2.5	.76	6	1.82	1.4	.43	.6	.18
32 mm (1.25")	2.8	.85	2.3	.7	3.8	1.15	7	2.13	1.8	.54	.8	.24
38 mm (1.5")	3.5	1.06	2.7	.82	4	1.21	8	2.44	2.1	.64	1	.3
51 mm (2")	4.5	1.37	4.3	1.31	5.7	1.74	12	3.66	2.6	.79	1.5	.46
63.5 mm (2.5")	5.5	1.67	5.1	1.55	6.9	2.1	15	4.57	3.1	.94	2	.61
76.2mm (3")	6.5	1.98	6.2	1.89	7.9	2.4	16	4.87	4	1.21	3	.91

**A.1.D.1. Liquid Volume of Pipes**

A.1.D.1. Liquid Volume of Pipes		
Nominal Pipe Diameter, Inches	Volume (per 100 feet of pipe)	
	Litres	Imp Gallons
3/4	8.7	1.9
1	17	3.74
1 1/4	30	6.48
1 1/2	40	8.82
2	66	14.66
3	145	30
4	250	55.1

**A.1.E.1. Effluent Soil Loading Rates and Linear Loading Rates (Imp. gal.)**

Table A.1.E.1. Effluent Soil Loading Rates and linear loading Rates (Imp. Gal.)													
Soil Characteristics		infiltration loading rate: gal/day/ft <sup>2</sup>		Hydraulic Linear Loading Rate, gal/day/ft									
				Slope of land									
				0 - 4%			>4 - 9%			>9%			
Texture	Structure		effluent Quality cBOD <sub>5</sub>		infiltration distance, in. <sup>1</sup>			infiltration distance, in. <sup>1</sup>			infiltration distance, in. <sup>1</sup>		
	Shape	grade	30-150mg/L	<30mg/L	12<24	24<48	48-<60	12<24	24<48	48-<60	12<24	24<48	48-<60
COS <sup>2</sup> , MS, LCOS, LMS Requires pressure distribution	--	OSG	0.3	0.3	5.0	6.0	7.0	6.0	7.0	8.0	7.0	8.0	9.0
	FS, VFS, LFS, LVFS Requires pressure distribution	--	OSG	0.4	0.5	4.5	5.5	6.5	5.0	6.0	7.0	6.0	7.0
COSL, MSL Requires pressure distribution	--	OM	0.2	0.6	3.5	4.0	4.5	4.1	4.6	5.1	6.0	7.0	8.0
	PL	1	0.2	0.5	3.5	4.0	4.5	4.1	4.6	5.1	5.0	6.0	7.0
		2,3	0.0	0.2	2.5	3.0	3.5	2.7	3.2	3.7	2.9	3.4	3.9
	PR <sup>3</sup> /BK/ GR	1	0.4	0.6	4.5	5.5	6.5	5.0	6.0	7.0	6.0	7.0	8.0
2,3		0.6	0.6	4.5	5.5	6.0	5.0	6.0	7.0	6.0	7.0	8.0	
FSL, VFSL	--	OM	0.18	0.36	2.3	2.6	2.9	2.7	3.0	3.3	3.2	3.7	4.2
	PL	1	0.18	0.36	2.3	2.6	2.9	2.7	3.0	3.3	3.2	3.7	4.2
		2,3	0.0	0.15	2.5	3.0	3.5	2.7	3.2	3.7	2.9	3.4	3.9
	PR <sup>3</sup> /BK/ GR	1	0.18	0.45	3.5	4.0	4.5	3.8	4.3	4.8	4.1	4.6	5.1
2,3		0.32	0.63	3.8	4.3	4.8	4.1	4.6	5.1	4.4	4.9	5.4	
L	--	OM	0.18	0.45	2.3	2.6	2.9	2.7	3.0	3.3	3.2	3.7	4.2
	PL	1	0.3	0.45	3.5	4.0	4.5	3.8	4.3	4.8	4.1	4.6	5.1
		2,3	0.0	0.15	2.5	3.0	3.5	2.7	3.2	3.7	2.9	3.4	3.9
	PR <sup>3</sup> /BK/ GR	1	0.3	0.45	3.5	4.0	4.5	3.8	4.3	4.8	4.1	4.6	5.1
2,3		0.45	0.63	3.8	4.3	4.8	4.1	4.6	5.1	4.4	4.9	5.4	
SIL	--	OM	0.0	0.18	2.5	3.0	3.5	2.7	3.2	3.7	2.9	3.4	3.9
	PL	1	0.0	0.15	2.5	3.0	3.5	2.7	3.2	3.7	2.9	3.4	3.9
		2,3	0.0	0.0	-	-	-	-	-	-	-	-	-
	PR <sup>3</sup> /BK/ GR	1	0.3	0.45	2.7	3.0	3.3	3.0	3.3	3.6	3.5	4.0	4.5
2,3		0.45	0.63	3.2	3.7	4.2	3.5	4.0	4.5	3.8	4.3	4.8	
SCL, CL, SICL, SI	--	OM	0.0	0.0	-	-	--	-	-	--	-	-	--
	PL	1	0.0	0.15	1.7	2.2	2.7	1.9	2.4	2.9	2.1	2.6	3.1
		2,3	0.0	0.0	-	-	-	-	-	-	-	-	-
	PR <sup>3</sup> /BK/ GR	1	0.18	0.27	2.5	3.0	3.5	2.7	3.2	3.7	2.9	3.4	3.9
2,3		0.27	0.45	2.9	3.4	3.9	3.2	3.7	4.2	3.5	4.0	4.5	
SC, C, SIC	--	OM	0.0	0.0	--	--	--	--	--	--	--	--	--
	PL	1,2,3	0.0	0.0	--	--	--	--	--	--	--	--	--
		PR <sup>3</sup> /BK/ GR	1	0.0	0.0	--	--	--	--	--	--	--	--
	2,3	0.14	0.20	2.5	3.0	3.5	2.7	3.2	3.7	2.9	3.4	3.9	
HC	--	OM	0.0	0.0	--	--	--	--	--	--	--	--	--
	PL	1,2,3	0.0	0.0	--	--	--	--	--	--	--	--	--
		PR <sup>3</sup> /BK/ GR	1	0.0	0.0	--	--	--	--	--	--	--	--
	2,3	0.09	0.16	2.1	2.6	3.1	2.3	2.8	3.3	2.5	3.0	3.5	

**Table A.1.E.1. Soil Texture and Structure Abbreviations**

<b>Soil Texture and Structure Abbreviations</b>					
COS Coarse Sand		LVFS Loamy Very Fine Sand		SI Silt	
MS Medium Sand		COSL Coarse Sandy Loam		SCL Sandy Clay Loam	
LCOS Loamy Coarse Sand		MSL Medium Sandy Loam		CL Clay Loam	
LMS Loamy Medium Sand		FSL Fine Sandy Loam		SICL Silty Clay Loam	
FS Fine Sand		VFSL Very Fine Sandy Loam		SC Sandy Clay	
LFS Loamy Fine Sand		L Loam		SIC Silty Clay	
VFS Very Fine Sand		SIL Silt Loam		C Clay	HC Heavy Clay
<b>PL</b> Platy	<b>PR</b> Prismatic	<b>BK</b> Blocky	<b>GR</b> Granular	<b>M</b> Massive	<b>SG</b> Single Grain
<b>0</b> Structureless	<b>1</b> Weak	<b>2</b> Moderate	<b>3</b> Strong		

<sup>1</sup> Note: infiltration distance is the depth of suitable soil below the in situ soil infiltration surface the effluent is applied to and the restrictive condition.

Table 8.1.1.10. infiltration rates in gal/d/sq. ft. of wastewater effluent strength of >30 mg/L cBOD5 or wastewater effluent strength of <30 mg/L cBOD5 and hydraulic linear loading rates in gal/d/ft. of system length based on soil characteristics of texture and structure and the site conditions of slope and infiltration depth to restrictive soil layers. Values assume daily wastewater volume estimates used in the design are based on the values set out in Subsection 2.2.2. or include the same safety factor. If horizon consistence is stronger than firm or any cemented class or the clay mineralogy is smectitic, the horizon is restrictive regardless of other soil characteristics {adapted from 2000, E. Jerry Tyler}.

<sup>2</sup> Note: The application of effluent to Coarse Sand textured soil is not allowed except where the requirements of Sentence 8.1.1.3.(2) are met.

<sup>3</sup> See restriction on prismatic soils set out in Sentence 8.1.1.10.(4)



## A.2. Lagoon System Design Data

### A.2.A. Precipitation Rates

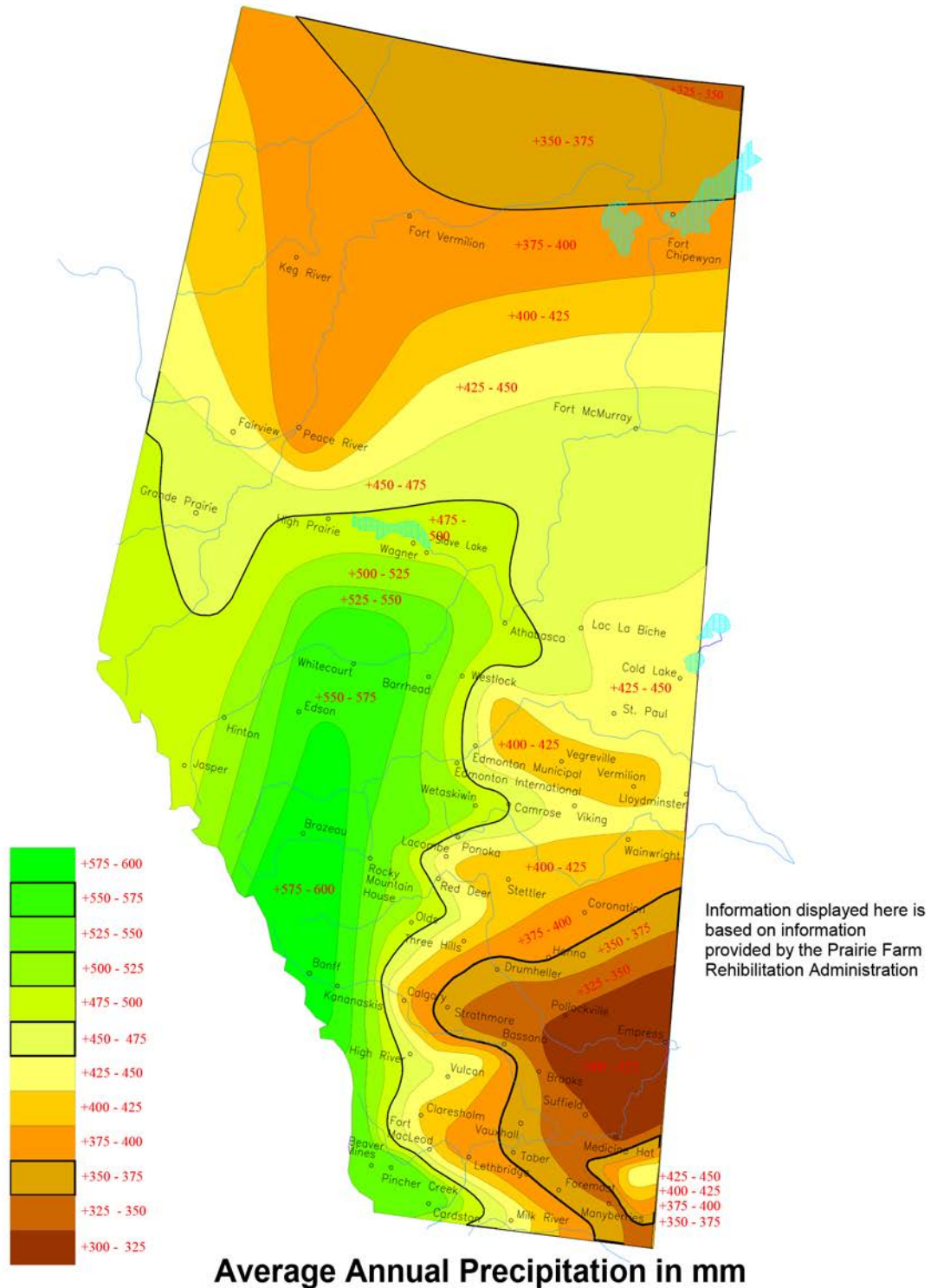

### A.2.B. Evaporation Rates

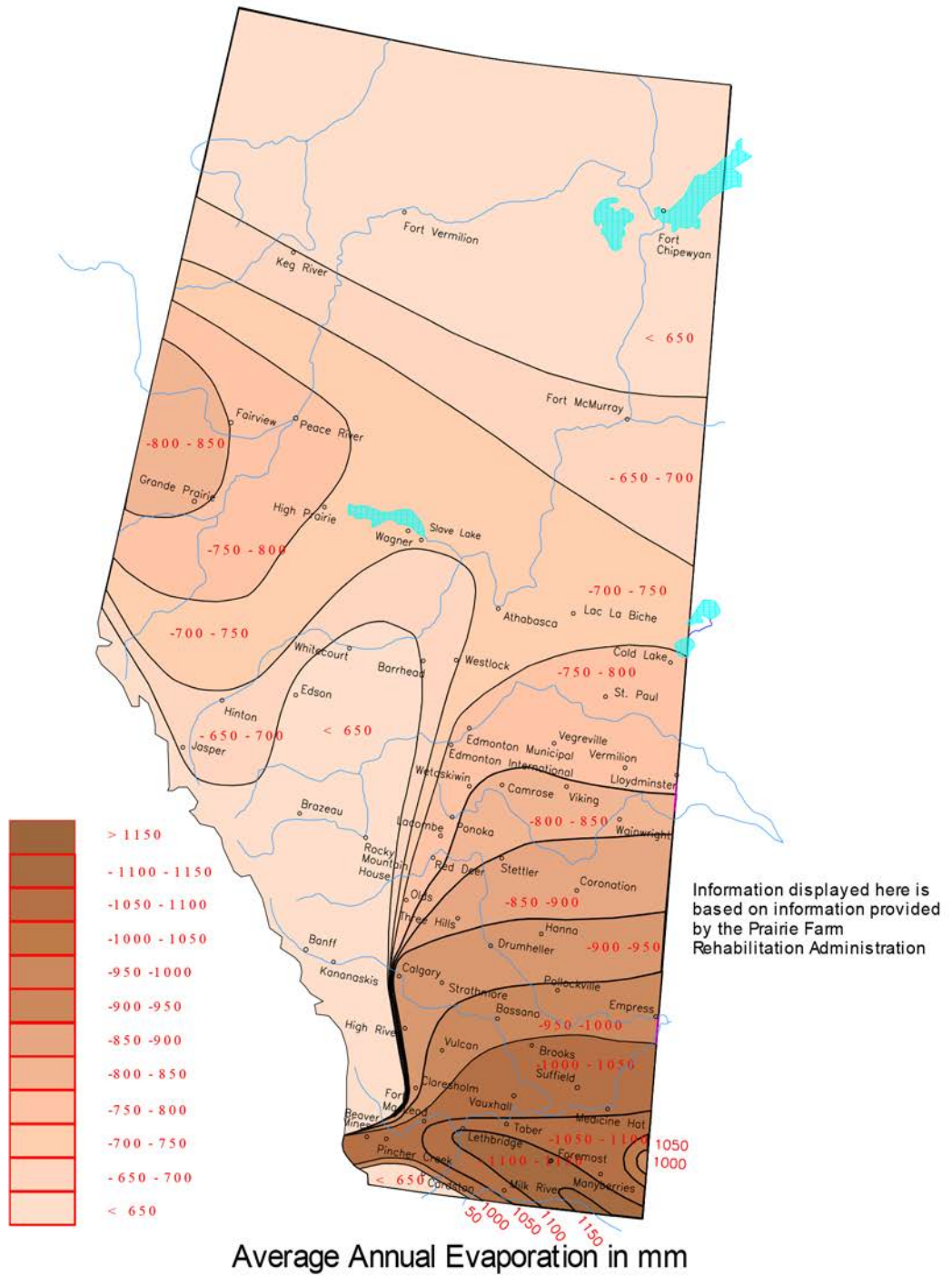

### A.2.C. Calculation of Lagoon Surface Area Requirements for Evaporation

**Note:** The following formulas are used to determine the required surface area of a lagoon to accomplish the evaporation of 150% of the expected average sewage volume per year based on average precipitation and evaporation rates (factor of safety = 1.25).

$$\text{Gallons of Evaporation per Sq. Ft per Year} = \frac{(\text{inches of evaporation per year} - \text{inches of precipitation per year}) \times 144}{277 \text{ cubic inches per Imperial gallon}}$$

$$\text{Litres of Evaporation per Sq. M. per Year} = (\text{mm of Evaporation per year} - \text{mm of Precipitation per year}) \times 1$$

$$\text{Square Feet Required} = \frac{\text{Average Gallons of Sewage per Year} \times 1.5}{\text{Gallons of Evaporation per Square Foot per Year}}$$

$$\text{Square Metres Required} = \frac{\text{Average Litres of Sewage per Year} \times 1.5}{\text{Litres of Evaporation per Square Metre per Year}}$$

## A.2.D. Lagoon Volumes

A.2.D. Calculation of Sewage Lagoon Volume				
Approximate Volume in Litres (gal.)	Size at Base in Metres (ft.)	Size at Mid Depth 750 mm (2.5 ft.)	Size at Full Depth 1500 mm ( 5 ft.)	Size at Top of Berm 600 mm (2.0 ft.) Freeboard, (2100 mm (7.0 ft.) Above Bottom of Lagoon)
138,106 (30,420)	4.57 x 4.57 (15 ft. x 15 ft.)	9.14 x 9.14 (30 ft. x 30 ft.)	13.72 x 13.72 (45 ft. x 45 ft.)	17.37 x 17.37 (57 ft. x 57 ft.)
184,142 (40,560)	6.10 x 6.10 (20 ft. x 20 ft.)	10.67 x 10.67 (35 ft. x 35 ft.)	15.24 x 15.24 (50 ft. x 50 ft.)	18.90 x 18.90 (62 ft. x 62 ft.)
237,260 (52,260)	7.62 x 7.62 (25 ft. x 25 ft.)	12.19 x 12.19 (40 ft. x 40 ft.)	16.76 x 16.76 (55 ft. x 55 ft.)	18.90 x 18.90 (67 ft. x 67 ft.)
297,460 (62,520)	9.14 x 9.14 (30 ft. x 30 ft.)	13.72 x 13.72 (45 ft. x 45 ft.)	18.29 x 18.29 (60 ft. x 60 ft.)	21.95 x 21.96 (72 ft. x 72 ft.)
364,743 (80,340)	10.67 x 10.67 (35 ft. x 35 ft.)	15.24 x 15.24 (50 ft. x 50 ft.)	19.81 x 19.81 (65 ft. x 65 ft.)	23.47 x 23.47 (77 ft. x 77 ft.)
439,109 (96,720)	12.19 x 12.19 (40 ft. x 40 ft.)	16.76 x 16.76 (55 ft. x 55 ft.)	21.34 x 21.34 (70 ft. x 70 ft.)	24.99 x 24.99 (82 ft. x 82 ft.)
609,086 (134,160)	15.24 x 15.24 (50 ft. x 50 ft.)	19.21 x 19.11 (65 ft. x 65 ft.)	24.38 x 24.38 (80 ft. x 80 ft.)	28.04 x 28.04 (92 ft. x 92 ft.)
807,393 (177,840)	18.29 x 18.29 (60 ft. x 60 ft.)	22.86 x 22.86 (75 ft. x 75 ft.)	27.43 x 27.43 (90 ft. x 90 ft.)	31.09 x 31.09 (102 ft. x 102 ft.)
1,034,030 (227,760)	21.34 x 21.34 (70 ft. x 70 ft.)	25.91 x 25.91 (85 ft. x 85 ft.)	30.48 x 30.48 (100 ft. x 100)	34.14 x 34.14 (112 ft. x 112 ft.)
1,883,918 (414,960)	30.48 x 30.48 (100 ft. x 100 ft.)	35.05 x 35.05 (115 ft. x 115 ft.)	39.62 x 39.62 (130 ft. x 130)	43.28 x 43.28 (142 ft. x 142 ft.)
2,592,158 (570,960)	36.58 x 36.58 (120 ft. x 120 ft.)	41.15 x 41.15 (135 ft. x 135 ft.)	45.72 x 45.72 (150 ft. x 150)	49.38 x 49.38 (162 ft. x 162 ft.)
3,866,990 (851,760)	45.72 x 45.72 (150 ft. x 150 ft.)	50.29 x 58.21 (165 ft. x 165 ft.)	54.86 x 54.86 (180 ft. x 180)	58.52 x 58.52 (192 ft. x 192 ft.)
4,514,694 (1,128,660)	53.34 x 53.34 (175 ft. x 175 ft.)	57.91 x 57.91 (190 ft. x 190 ft.)	62.48 x 62.48 (205 ft. x 205)	66.14 x 66.14 (217 ft. x 217 ft.)
6,558,302 (1,444,560)	60.96 x 60.96 (200 ft. x 200 ft.)	65.53 x 65.53 (215 ft. x 215 ft.)	70.10 x 70.10 (230 ft. x 230)	73.76 x 73.76 (242 ft. x 242 ft.)
9,957,854 (2,193,360)	76.20 x 76.20 (250 ft. x 250 ft.)	80.77 x 80.77 (265 ft. x 265 ft.)	85.34 x 85.34 (280 ft. x 280)	89.0 x 89.0 (292 ft. x 292 ft.)
14,065,646 (3,098,160)	91.44 x 91.44 (300 ft. x 300 ft.)	96.01 x 96.01 (315 ft. x 315 ft.)	100.60 x 100.60 (330 ft. x 330)	104.3 x 104.3 (342 ft. x 342 ft.)
24,405,905 (5,375,760)	121.90 x 121.50 (400 ft. x 400 ft.)	126.50 x 126.50 (415 ft. x 415 ft.)	131.1 x 131.1 (430 ft. x 430)	134.7 x 134.7 (442 ft. x 442 ft.)

Note: To calculate the volume of a square or rectangular lagoon of a size not listed above, the following formula may be used based on an inside berm slope of 3 horizontal to 1 vertical.

**Volume={H} over {0.167} times (A+4B+C) times 28.33**

V = Volume in litres  
H = Depth of liquid (maximum of 1.5 metres)  
A = Area of bottom of lagoon in square metres  
B = Area at mid-depth in square metres  
C = Area at the high water level in square metres (maximum 1.5 metre depth)

## A.3. Alberta Design Data

A.3.A. Alberta Climate Design Data by Town									
Site Name	Elevation (m)	Design Temperature				Degree-Days Below 18°C	15 Min. Rain, mm	One Day Rain, 1/50, mm	Ann. Tot. Ppn., mm
		January		July 2.5%					
		2.5% °C	1%°C	Dry °C	Wet °C				
Acadia Valley	716	-33	-36	31	20	5500	18	75	310
Airdrie	1098	-32	-34	28	18	5200	17	95	440
Athabasca	515	-35	-38	28	19	6000	18	86	480
Banff	1400	-30	-32	27	17	5500	18	65	500
Barrhead	645	-34	-37	28	19	6000	20	86	475
Bashaw	793	-36	-39	27	19	5600	21	85	460
Bassano	792	-32	-34	28	18	5350	17	85	340
Beaumont	735	-37	-40	27	19	5700	20	90	475
Beaver Lodge	730	-35	-38	28	18	5900	25	92	470
Berwyn	643	-40	-42	27	18	6350	14	80	395
Black Diamond	1159	-32	-34	28	18	5300	16	90	495
Blackfalds	880	-34	-38	28	19	5700	19	95	475
Bon Accord	625	-37	-40	27	19	5750	19	85	485
Bonnyville	564	-36	-39	28	20	6100	21	75	430
Bow Island	799	-32	-36	32	20	4800	17	80	340
Bowden	991	-34	-38	28	19	5700	17	95	480
Brooks	760	-32	-34	32	19	5200	18	86	340
Bruderheim	637	-37	-40	27	19	5800	19	95	480
Calgary	1045	-31	-33	29	17	5200	23	103	425
Calmar	730	-35	-38	27	19	5600	20	95	490
Campsie	660	-34	-37	28	19	6000	20	86	475
Camrose	740	-33	-35	29	19	5700	20	92	470
Canmore	1375	-31	-32	27	17	5500	18	65	500
Cardston	1130	-30	-33	29	18	4750	20	108	550
Carstairs	1060	-33	-36	28	18	5600	17	105	475
Castor	816	-33	-36	29	20	5600	21	85	405
Claresholm	1030	-31	-34	29	18	4800	15	103	440
Coaldale	863	-31	-35	31	19	4700	17	85	390
Cochrane	1159	-32	-34	28	18	5400	17	75	500
Cold Lake	540	-36	-38	28	20	6100	15	81	430
Coleman	1320	-31	-34	28	18	5300	15	76	550
Coronation	790	-31	-33	30	19	5800	20	92	400
Cowley	1175	-31	-34	29	18	5100	15	81	525
Crossfield	1113	-32	-34	28	18	5500	17	105	485
Daysland	708	-36	-39	28	19	5700	21	85	455
Devon	709	-37	-40	27	19	5600	20	90	490
Didsbury	1037	-33	-36	28	18	5600	17	100	480
Drayton Valley	869	-35	-37	27	19	5700	20	85	525
Drumheller	685	-31	-33	29	18	5300	20	86	375
Eckville	930	-34	-37	27	19	5700	17	105	540
Edmonton	645	-32	-34	28	19	5400	23	97	460
Edson	920	-34	-37	28	18	5900	18	81	570
Elk Point	598	-38	-40	28	20	6200	21	75	440
Embarras Portage	220	-41	-44	27	19	7100	10	86	390
Fairview	670	-38	-40	27	18	6050	15	86	450
Falher	587	-40	-42	27	18	5900	15	55	420
Foremost	889	-32	-36	32	20	4800	14	70	360
Fort Chipewayan	221	-43	-46	26	19	7400	12	70	381
Fort MacLeod	945	-31	-33	31	18	4600	16	97	425
Fort McMurray	255	-39	-41	28	19	6550	13	92	460
Fort Saskatchewan	610	-32	-35	28	19	5700	20	86	425
Fort Vermilion	270	-41	-43	28	18	6900	13	65	380
Fox Creek	808	-36	-40	27	19	5900	17	90	550

<b>A.3.A. Alberta Climate Design Data by Town (continued)</b>									
Site Name	Elevation (m)	Design Temperature				Degree-Days Below 18°C	15 Min. Rain, mm	One Day Rain, 1/50, mm	Ann. Tot. Ppn., mm
		January		July 2.5%					
		2.5% °C	1%°C	Dry °C	Wet °C				
Gibbons	643	-37	-40	27	19	5800	19	85	485
Gleichen	903	-32	-34	28	18	5300	17	90	360
Grand Centre	541	-36	-39	28	20	6100	21	75	435
Grande Cache	1220	-35	-38	27	15	5700	14	70	605
Grande Prairie	650	-36	-39	27	18	6000	23	86	450
Granum	991	-33	-36	30	18	4800	17	95	440
Grimshaw	603	-40	-42	27	18	6350	14	80	390
Habay	335	-41	-43	28	18	7150	13	70	425
Hanna	785	-33	-36	29	20	5700	19	90	390
Hardisty	615	-33	-35	30	19	5900	20	76	425
High Level	320	-46	-47	26	18	7200	11	75	420
High Prairie	595	-38	-40	25	19	6000	15	75	470
High River	1040	-31	-33	28	17	5300	18	103	425
Hinton	990	-34	-38	27	17	5700	13	81	500
Innisfail	945	-34	-38	28	19	5700	18	95	480
Irvine	763	-32	-36	32	20	4900	17	75	360
Jasper	1060	-32	-35	28	18	5500	10	76	400
Keg River	420	-40	-42	28	18	6800	13	65	450
Killam	680	-35	-38	29	20	5700	21	90	445
Kitscoty	670	-35	-38	29	20	6150	22	80	430
Lac la Biche	560	-35	-38	28	19	6150	15	86	475
Lacombe	855	-33	-35	29	18	5700	23	92	450
Lake Louise	1600	-33	-34	27	14	6700	11	55	580
Lamont	653	-37	-40	27	19	5800	19	90	460
Leduc	730	-35	-38	27	19	5600	20	90	485
Lethbridge	910	-30	-33	31	18	4650	20	97	390
Lloydminster	645	-35	-38	29	20	6100	18	70	430
Magrath	983	-31	-35	31	19	4800	17	80	430
Manning	465	-39	-41	27	18	6700	13	81	390
Mayerthorpe	712	-36	-40	27	19	5950	15	90	555
McLennan	625	-40	-42	27	18	5900	15	65	425
Medicine Hat	705	-31	-34	33	19	4750	23	92	325
Milk River	1059	-31	-35	31	19	4800	16	70	375
Millet	755	-35	-38	27	19	5600	21	95	475
Morinville	700	-37	-40	27	19	5700	19	90	480
Morrin	832	-34	-38	28	19	5500	19	75	390
Mundare	578	-37	-40	27	19	6100	20	90	450
Nanton	1024	-32	-34	28	18	5000	17	95	440
Okotoks	1051	-32	-34	28	18	5300	17	95	470
Olds	1041	-33	-36	28	18	5600	17	95	485
Oyen	770	-33	-36	29	20	5600	19	75	330
Peace River	330	-37	-40	27	18	6350	15	65	390
Penhold	871	-34	-38	28	19	5750	18	95	470
Picture Butte	905	-31	-35	31	19	4700	17	85	400
Pincher Creek	1130	-32	-34	29	18	5000	18	108	575
Ponoka	807	-34	-37	27	19	5600	21	80	480
Provost	668	-33	-36	29	20	5900	21	80	415
Rainbow Lake	534	-46	-47	26	18	7200	16	75	450
Ranfurly	670	-34	-37	29	19	5950	18	92	420
Raymond	960	-31	-35	31	19	4750	17	75	420
Red Deer	855	-32	-35	29	18	5750	23	97	475
Redcliff	745	-32	-36	32	20	4800	17	85	325
Redwater	625	-37	-40	27	19	5900	19	80	470

**A.3.A. Alberta Climate Design Data by Town (continued)**

Site Name	Elevation (m)	Design Temperature				Degree- Days Below 18°C	15 Min. Rain, mm	One Day Rain, 1/50, mm	Ann. Tot. Ppn., mm
		January		July 2.5%					
		2.5% °C	1%°C	Dry °C	Wet °C				
Rimbey	930	-34	-37	27	19	5700	20	100	505
Rocky									
Mountain House	985	-31	-33	28	18	5700	20	86	550
Ryley	693	-35	-38	27	19	5800	21	90	465
Sangudo	680	-36	-40	27	19	5900	17	95	555
Sedgewick	663	-35	-38	29	20	5700	21	95	440
Sexsmith	724	-38	-41	27	18	6000	18	85	445
Sherwood Park	729	-37	-40	27	19	5500	20	90	480
Slave Lake	590	-36	-39	27	19	6000	15	81	500
Smoky Lake	623	-39	-42	27	20	6000	19	75	480
Spirit River	640	-38	-41	27	18	6200	18	75	440
Spruce Grove	709	-37	-40	27	19	5600	19	90	500
Stavely	1044	-33	-36	30	18	4800	17	95	440
Stettler	820	-32	-34	30	19	5700	20	97	450
Stony Plain	710	-32	-35	28	19	5500	23	97	540
Strathmore	973	-32	-34	28	18	5300	17	80	430
St. Albert	689	-37	-40	27	19	5600	20	95	480
St. Paul	646	-37	-40	28	20	6100	21	75	440
Suffield	755	-32	-34	33	19	4900	20	86	325
Sundre	1093	-34	-37	27	19	5700	15	95	530
Swan Hills	1113	-36	-40	27	19	6100	15	95	500
Sylvan Lake	945	-34	-37	27	19	5700	18	95	545
Taber	815	-31	-33	31	19	4800	20	92	370
Thorhild	649	-37	-40	27	19	6000	17	75	480
Three Hills	896	-34	-38	28	19	5450	19	80	400
Tofield	700	-37	-40	27	19	5800	21	95	465
Trochu	872	-34	-38	28	19	5450	18	75	405
Turner Valley	1215	-31	-33	28	17	5600	20	97	600
Two Hills	603	-38	-40	28	20	6000	21	80	450
Valleyview	700	-37	-40	27	18	5900	18	86	490
Vauxhall	779	-31	-35	31	19	4850	17	85	335
Vegreville	635	-34	-36	29	19	6100	18	86	410
Vermilion	580	-35	-38	29	20	6150	18	86	410
Viking	691	-38	-40	28	20	5750	21	65	445
Vulcan	1049	-31	-34	30	18	5000	17	90	410
Wagner	585	-36	-39	27	19	6000	15	76	500
Wainwright	675	-33	-36	29	19	6000	20	81	425
Warner	1021	-31	-35	31	19	4750	16	75	375
Wembley	724	-38	-41	27	18	5900	18	85	470
Westlock	648	-37	-40	27	19	5900	17	75	490
Wetaskiwin	760	-33	-35	29	19	5800	23	86	500
WhiteCourt	690	-35	-38	27	18	6000	20	97	550
Wimborne	975	-31	-34	29	18	5650	23	92	450

### A.3.B. Soil Clay Content Map

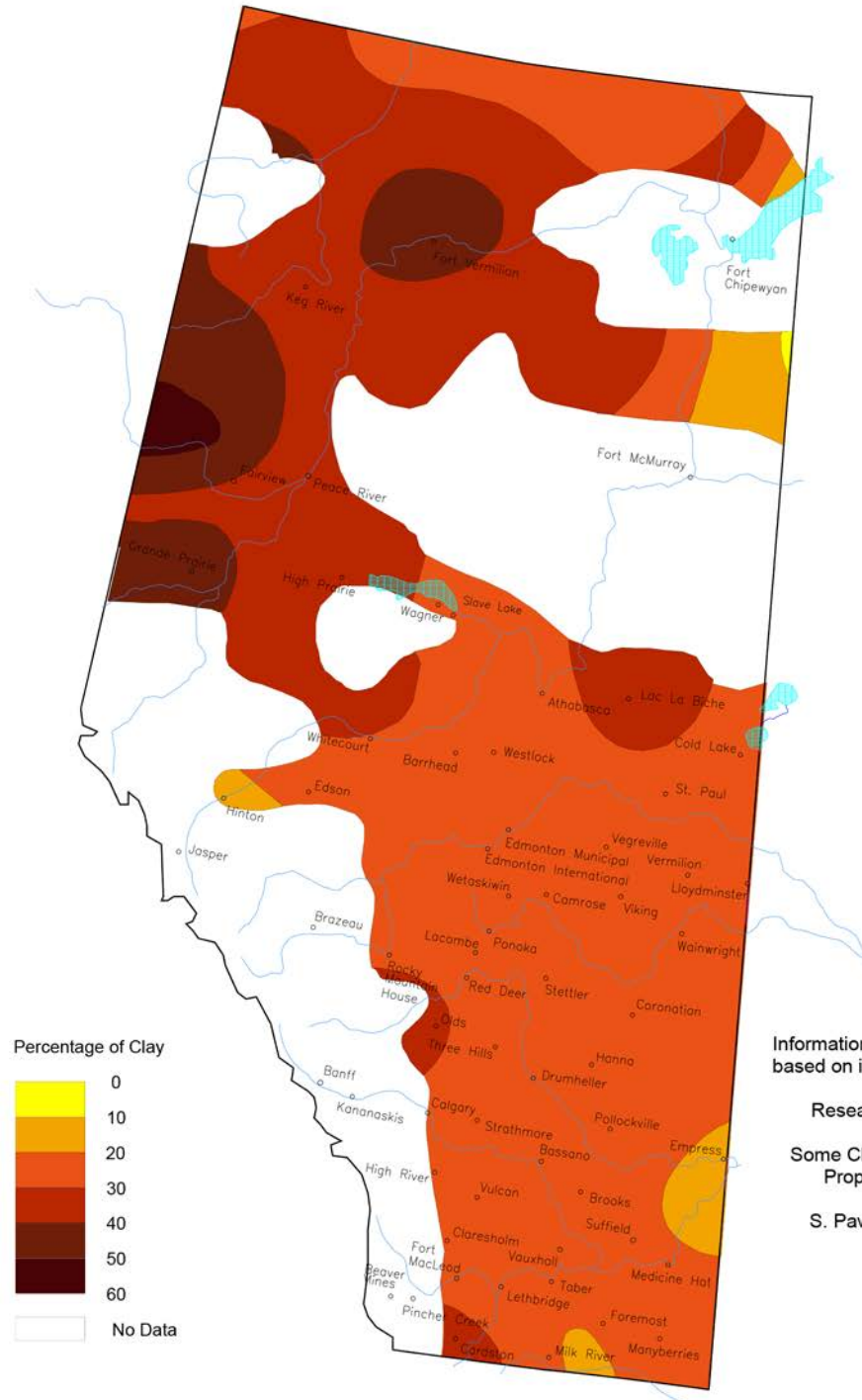

Distribution of Clay



### A.3.C. Soil Montmorillonite Content Map

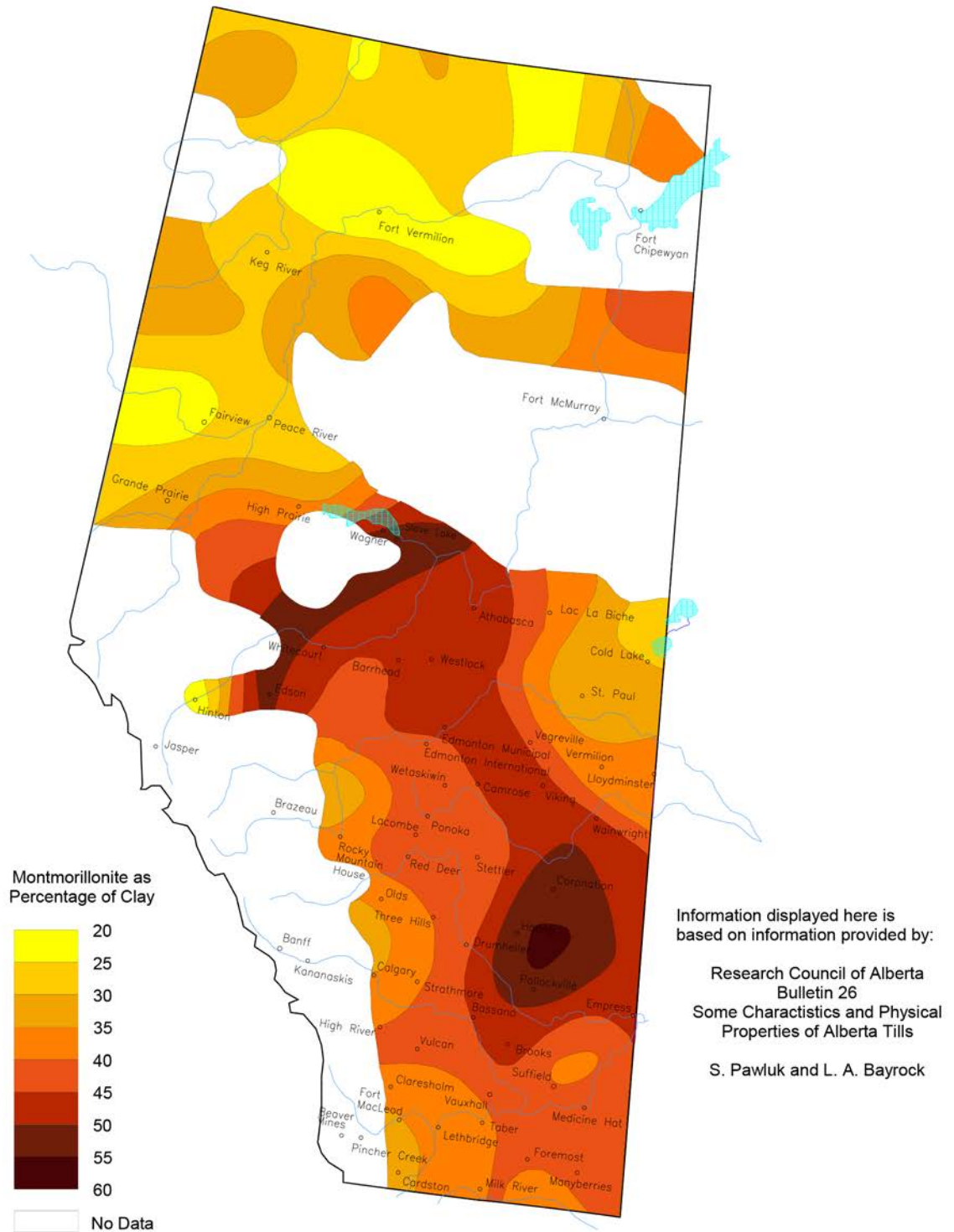

Distribution of Montmorillonite

## A.4. Treatment Field Design Data

<b>A.4.A. Disposal Field Loading Rates Per Day and Sizes</b>											
		2 Bedrooms		3 Bedrooms		4 Bedrooms		5 Bedrooms		6 Bedrooms	
Loading Rate, L/m <sup>2</sup>	Loading Rate, Imp. gal./sq.ft.	Square Metres	Sq. ft.	Square Metres	Sq. ft.	Square Metres	Sq. ft.	Square Metres	Sq. ft.	Square Metres	Sq. ft.
		2 Bedrooms = 340x2x2	2 Bedrooms = 75x2x2	3 Bedrooms = 340x1.5x3	3 Bedrooms = 75x1.5x3	4 Bedrooms = 340x1.5x4	4 Bedrooms = 75x1.5x4	5 Bedrooms = 340x1.5x5	5 Bedrooms = 75x1.5x5	6 Bedrooms = 340x1.5x6	6 Bedrooms = 75x1.5x6
per day		1360 L	300 gal	1530 L	337.5 gal	2040 L	450 gal	2550 L	562.5 gal	3060 L	675 gal
4.89	0.10	277.93	3000.00	312.67	3375.00	416.90	4500.00	521.12	5625.00	625.34	6750.00
5.38	0.11	252.66	2727.27	284.25	3068.18	379.00	4090.91	473.74	5113.64	568.49	6136.36
5.87	0.12	231.66	2500.00	260.56	2812.50	347.41	3750.00	434.27	4687.50	521.12	5625.00
6.36	0.13	213.79	2307.69	240.52	2596.15	320.69	3461.54	400.86	4326.92	481.03	5192.31
6.85	0.14	198.52	2142.86	223.34	2410.71	297.78	3214.29	372.23	4017.86	446.67	4821.43
7.34	0.15	185.29	2000.00	208.45	2250.00	277.93	3000.00	347.41	3750.00	416.90	4500.00
7.83	0.16	173.71	1875.00	195.42	2109.38	260.56	2812.50	325.70	3515.63	390.84	4218.75
8.32	0.17	163.49	1764.71	183.92	1985.29	245.23	2647.06	306.54	3308.82	367.85	3970.59
8.81	0.18	154.41	1666.67	173.71	1875.00	231.61	2500.00	289.51	3125.00	347.41	3750.00
9.30	0.19	146.28	1578.95	164.56	1776.32	219.42	2368.42	274.27	2960.53	329.13	3552.63
9.79	0.20	138.97	1500.00	156.34	1687.50	208.45	2250.00	260.56	2812.50	312.67	3375.00
10.28	0.21	132.35	1428.57	148.89	1607.14	198.52	2142.86	248.15	2678.57	297.78	3214.29
10.77	0.22	126.33	1363.64	142.12	1534.09	189.50	2045.45	236.87	2556.82	284.25	3068.18
11.25	0.23	120.84	1304.35	135.94	1467.39	181.26	1956.52	226.57	2445.65	271.89	2934.78
11.74	0.24	115.80	1250.00	130.28	1406.25	173.71	1875.00	217.13	2343.75	260.56	2812.50
12.23	0.25	111.17	1200.00	125.07	1350.00	166.76	1800.00	208.45	2250.00	250.14	2700.00
12.72	0.26	106.90	1153.85	120.26	1298.08	160.34	1730.77	200.43	2163.46	240.52	2596.15
13.21	0.27	102.94	1111.11	115.80	1250.00	154.41	1666.67	193.01	2083.33	231.61	2500.00
13.70	0.28	99.26	1071.43	111.67	1205.36	148.89	1607.14	186.11	2008.93	223.34	2410.71
14.19	0.29	95.84	1034.48	107.82	1163.79	143.76	1551.72	179.70	1939.66	215.64	2327.59
14.68	0.30	92.64	1000.00	104.22	1125.00	138.97	1500.00	173.71	1875.00	208.45	2250.00
15.17	0.31	89.65	967.74	100.86	1088.71	134.48	1451.61	168.10	1814.52	201.72	2177.42
15.66	0.32	86.85	937.50	97.71	1054.69	130.28	1406.25	162.85	1757.81	195.42	2109.38
16.15	0.33	84.22	909.09	94.75	1022.73	126.33	1363.64	157.91	1704.55	189.50	2045.45
16.64	0.34	81.74	882.35	91.96	992.65	122.62	1323.53	153.27	1654.41	183.92	1985.29
17.13	0.35	79.41	857.14	89.33	964.29	119.11	1285.71	148.89	1607.14	178.67	1928.57
17.62	0.36	77.20	833.33	86.85	937.50	115.80	1250.00	144.76	1562.50	173.71	1875.00
18.11	0.37	75.12	810.81	84.51	912.16	112.67	1216.22	140.84	1520.27	169.01	1824.32
18.59	0.38	73.14	789.47	82.28	888.16	109.71	1184.21	137.14	1480.26	164.56	1776.32
19.08	0.39	71.26	769.23	80.17	865.38	106.90	1153.85	133.62	1442.31	160.34	1730.77
19.57	0.40	69.48	750.00	78.17	843.75	104.22	1125.00	130.28	1406.25	156.34	1687.50
20.06	0.41	67.79	731.71	76.26	823.17	101.68	1097.56	127.10	1371.95	152.52	1646.34
20.55	0.42	66.17	714.29	74.45	803.57	99.26	1071.43	124.08	1339.29	148.89	1607.14
21.04	0.43	64.63	697.67	72.71	784.88	96.95	1046.51	121.19	1308.14	145.43	1569.77
21.53	0.44	63.17	681.82	71.06	767.05	94.75	1022.73	118.44	1278.41	142.12	1534.09
22.02	0.45	61.76	666.67	69.48	750.00	92.64	1000.00	115.80	1250.00	138.97	1500.00

<b>A.4.A. Disposal Field Loading Rates Per Day and Sizes (continued)</b>											
		2 Bedrooms		3 Bedrooms		4 Bedrooms		5 Bedrooms		6 Bedrooms	
Loading Rate, L/m <sup>2</sup>	Loading Rate, Imp. gal./sq.ft.	Square Metres	Sq. ft.	Square Metres	Sq. ft.	Square Metres	Sq. ft.	Square Metres	Sq. ft.	Square Metres	Sq. ft.
		2 Bedrooms = 340x2x2	2 Bedrooms = 75x2x2	3 Bedrooms = 340x1.5x3	3 Bedrooms = 75x1.5x3	4 Bedrooms = 340x1.5x4	4 Bedrooms = 75x1.5x4	5 Bedrooms = 340x1.5x5	5 Bedrooms = 75x1.5x5	6 Bedrooms = 340x1.5x6	6 Bedrooms = 75x1.5x6
per day		1360 L	300 gal	1530 L	337.5 gal	2040 L	450 gal	2550 L	562.5 gal	3060 L	675 gal
22.51	0.46	60.42	652.17	67.97	733.70	90.63	978.26	113.29	1222.83	135.94	1467.39
23.00	0.47	59.13	638.30	66.53	718.09	88.70	957.45	110.88	1196.81	133.05	1436.17
23.49	0.48	57.90	625.00	65.14	703.13	86.85	937.50	108.57	1171.88	130.28	1406.25
23.98	0.49	56.72	612.24	63.81	688.78	85.08	918.37	106.35	1147.96	127.62	1377.55
24.47	0.50	55.59	600.00	62.53	675.00	83.38	900.00	104.22	1125.00	125.07	1350.00
24.96	0.51	54.50	588.24	61.31	661.76	81.74	882.35	102.18	1102.94	122.62	1323.53
25.45	0.52	53.45	576.92	60.13	649.04	80.17	865.38	100.22	1081.73	120.26	1298.08
25.93	0.53	52.44	566.04	58.99	636.79	78.66	849.06	98.32	1061.32	117.99	1273.58
26.42	0.54	51.47	555.56	57.90	625.00	77.20	833.33	96.50	1041.67	115.80	1250.00
26.91	0.55	50.53	545.45	56.85	613.64	75.80	818.18	94.75	1022.73	113.70	1227.27
27.40	0.56	49.63	535.71	55.83	602.68	74.45	803.57	93.06	1004.46	111.67	1205.36
27.89	0.57	48.76	526.32	54.85	592.11	73.14	789.47	91.42	986.84	109.71	1184.21
28.38	0.58	47.92	517.24	53.91	581.90	71.88	775.86	89.85	969.83	107.82	1163.79
28.87	0.59	47.11	508.47	53.00	572.03	70.66	762.71	88.33	953.39	105.99	1144.07
29.36	0.60	46.32	500.00	52.11	562.50	69.48	750.00	86.85	937.50	104.22	1125.00
29.85	0.61	45.56	491.80	51.26	553.28	68.34	737.70	85.43	922.13	102.52	1106.56
30.34	0.62	44.83	483.87	50.43	544.35	67.24	725.81	84.05	907.26	100.86	1088.71
30.83	0.63	44.12	476.19	49.63	535.71	66.17	714.29	82.72	892.86	99.26	1071.43
31.32	0.64	43.43	468.75	48.85	527.34	65.14	703.13	81.42	878.91	97.71	1054.69
31.81	0.65	42.76	461.54	48.10	519.23	64.14	692.31	80.17	865.38	96.21	1038.46
32.30	0.66	42.11	454.55	47.37	511.36	63.17	681.82	78.96	852.27	94.75	1022.73

## A.5. Acceptable Piping Materials Table

A.5.A. Piping Materials					
Type of Piping	Standard Reference	Gravity Sewage or Effluent Piping	Pressure Effluent Line	Weeping Lateral Piping	Pressure Effluent Distribution Lateral Pipe
Polyethylene water pipe and tubing  Series 160 sizes with compression fittings  Series 75, 100 and 125	CAN3-B137.1	N	P	N	N
Poly vinyl chloride (PVC) water pipe  Schedule 40, Schedule 80	CAN3-B137.3	P	P	P	P
Chlorinated poly vinyl chloride (CPVC) water pipe	CAN3-B137.6	N	N	N	P
Plastic Sewer Pipe perforated non perforated	CAN/CSA-B182.1	N P	N N	P N	N N
Corrugated Polyethylene perforated non-perforated	CGSB 41-GP-31	N P	N N	P N	N N
Acrylonitrile-butadiene-styrene (ABS) DWV pipe	CAN/CSA-B181.1	P	N	N	N
Poly (vinyl chloride) (PVC) DWV pipe	CAN/CSA-B181.2	P	N	N	N
Type PSM PVC sewer pipe > 35 SDR	CAN/CSA-B182.2	P	N	N	N
Profile poly (vinyl chloride) (PVC) sewer pipe PS 320 kPa	CAN/CSA-B182.6	P	N	N	N
Profile polyethylene sewer pipe PS 320 kPa	CAN/CSA-182.6	P	N	N	N
Cast iron soil pipe	CAN3-B70	P	N	N	N

<sup>1</sup> Note: The inlet and outlet piping connected to a tank are subject to distortion caused by settling of the tank and the excavation around the tank. Heavy wall pipe, and close excavation to minimize the distance to undisturbed earth, provides an added element of safety that is needed.

P = Permitted

N = Not Permitted

## A.6. Septic Tank Sludge and Scum Accumulation Rates for Other Than Residential

A.6.A. Septic tank Sludge and Scum Accumulation Rates			
Premises	Fixtures	Sludge/scum rate	
		Number of Persons	Rate: litres / person / year
Note: Calculate each use and add to obtain total capacity Note: The term average or highest daily number over an "x" day period means the highest number in any 12-month period			
RECREATIONAL VEHICLE PARKS			
Permanent Occupation	wc/urinal basin bath/shower laundry kitchen sink	Total number of sites x 3.5	80
Casual Occupation	wc/urinal basin bath/shower laundry kitchen sink	Average number of sites occupied per year x 3.5	48
CHILD DAY CARE CENTRES	wc/urinal basin bath/shower laundry kitchen sink	Total number of children and staff	48
CHURCHES, PUBLIC HALLS etc.	wc/urinal basin kitchen sink (coffee service area only)	12 month highest daily average number over 7-day period	25 for up to 4 days use/ week 40 when over 4 days use/ week
Addition	where kitchen area provided for catering		Add 10 to either of above
CLUBS			
Membership entry only. Members/guests & staff using facilities	wc/urinal basin bath/shower kitchen sink (coffee service area only)	Average daily number over 7-day period	35
Licensed area Bar trade only	wc/urinal basin bar sink glass washer	Average daily number over 7-day period	5
Licensed bar & restaurant/ meals area	wc/urinal basin kitchen sink dishwasher	Average daily number over 7-day period	10

<b>A.6.A. Septic Tank Sludge and Scum Accumulation Rates (continued)</b>			
<b>Premises</b>	<b>Fixtures</b>	<b>Sludge/scum rate</b>	
		<b>Number of Persons</b>	<b>Rate: litres / person / year</b>
COFFEE / TEA SHOPS / KIOSKS e.g. light refreshments and prepared food, cakes etc.	wc/urinal basin kitchen sink	Average daily number over 7-day period	30
CONSTRUCTION CAMPS - TEMPORARY	wc/urinal basin shower laundry kitchen sink dishwasher	Total number of persons using facilities	80
HOLIDAY CAMPS e.g. scout, youth and church centres with casual occupation  (staff and/or residential caretaker data to be included where applicable)	wc/urinal hand basin shower kitchen sink	Total number of beds (single equivalent)	48
HOSPITALS AND NURSING HOMES  Accommodation and resident staff	wc/urinal basin bath/shower laundry kitchen sink dishwasher	Total number of beds plus resident staff	80
Non-resident staff	wc/urinal basin kitchen sink (coffee service area only)	Number of employees per shift x number of shifts	25

<b>A.6.A. Septic Tank Sludge and Scum Accumulation Rates (continued)</b>			
<b>Premises</b>	<b>Fixtures</b>	<b>Sludge/scum rate</b>	
		<b>Number of Persons</b>	<b>Rate: litres / person / year</b>
<b>HOTELS / MOTELS / LIVE IN CONFERENCE CENTRES</b>			
Accommodation	wc/urinal basin bath/ shower kitchen sink laundry	Total number of beds (single equivalents)	48
Permanent residents, staff etc.	wc/urinal basin bath/ shower kitchen sink laundry	Total number of live in staff	80
Bar trade	wc/urinal basin bar sink glass washer	Average daily number attending in 7 day period	5
Dining room lounge area non-resident use	wc/urinal basin kitchen sink dishwasher	Average daily number of diners per 7 day period	10
Non-resident staff	wc/urinal basin kitchen sink (tea service area only)	Number of employees per shift x number of shifts	25
<b>MEDICAL CONSULTING ROOMS</b>			
e.g. doctors, dentists, etc.	wc/urinal basin kitchen sink (tea service area only)	Number of persons using system per shift x number of shifts	40
Staff			
Consulting rooms		Per consulting room	80
<b>PUBLIC SWIMMING POOLS</b>			
include kiosk e.g. take away food	wc/urinal basin shower kitchen sink (tea service area only)	Average daily number over 7 day period	20
<b>PUBLIC TOILETS</b>			
	wc/urinal basin	Average daily number over 7 day period	20
Addition:	where shower provided	as above	5

<b>A.6.A. Septic Tank Sludge and Scum Accumulation Rates (continued)</b>			
<b>Premises</b>	<b>Fixtures</b>	<b>Sludge/scum rate</b>	
		<b>Number of Persons</b>	<b>Rate: litres / person / year</b>
<b>RESTAURANTS</b>			
No liquor license	wc/urinal basin kitchen sink dishwasher	Average daily number over 7-day period plus staff	35
With liquor license	wc/urinal basin kitchen sink dishwasher glass washer	Average daily number over 7-day period plus staff	36
<b>REST HOMES, BOARDING &amp; LODGING HOUSES</b>			
Accommodation and resident staff	wc/urinal basin bath/shower laundry kitchen sink	Total number of beds plus resident staff (single equivalents)	80
Non-resident staff	wc/urinal basin kitchen sink (coffee service area only)	Number of employees per shift x number of shifts	25
<b>ROAD-HOUSES / SERVICE STATIONS</b>			
Staff	wc/urinal basin kitchen sink (coffee service area only)	Number of employees per shift x number of shifts	25
Public toilets	wc/urinal basin	Average daily number over 7-day period	20
	with shower	as above	5
Restaurant take away and sit down meals	wc/urinal basin kitchen sink dishwasher	Average daily number over 7-day period	10



<b>A.6.A. Septic Tank Sludge and Scum Accumulation Rates (continued)</b>			
<b>Premises</b>	<b>Fixtures</b>	<b>Sludge/scum rate</b>	
		<b>Number of Persons</b>	<b>Rate: litres / person / year</b>
<b>SCHOOLS</b>			
Including kiosk facilities e.g. take away food	wc/urinal basin kitchen sink	Total number of students plus staff	25
Where canteen facilities provided e.g. plated hot and cold meals	kitchen sink dishwasher	as above	10
<b>SEMINAR/CONFERENCE ROOMS</b>			
No meals	wc/urinal basin kitchen sink (coffee service area only)	Total seating capacity plus staff	25
Meals No liquor license	wc/urinal basin kitchen sink dishwasher glass washer	Total seating capacity plus staff	35
Meals with liquor license	wc/urinal basin kitchen sink dishwasher glass washer	Total seating capacity plus staff	35
	with shower	as above	5
Restaurant take away and sit down meals	wc/urinal basin kitchen sink dishwasher	Average daily number over 7-day period	10

<b>A.6.A. Septic Tank Sludge and Scum Accumulation Rates (continued)</b>			
<b>Premises</b>	<b>Fixtures</b>	<b>Sludge/scum rate</b>	
		<b>Number of Persons</b>	<b>Rate: litres / person / year</b>
<b>SHOPPING CENTRES</b>			
Staff	wc/urinal basin kitchen sink (coffee service area only)	Number of employees per shift x number of shifts	25
Public	wc/urinal basin	average daily number over 7-day period	20
Shop Facilities	double bowl sink basin	per shop	20
Supermarket	double bowl sink basin cleaners sink	per supermarket	40
<b>SPORTS CENTRES</b>			
e.g. health and fitness clubs, squash courts indoor hockey, basketball	wc/urinal basin shower kitchen sink (coffee service area only)	average daily number over 7-day period plus staff	25
<b>STAFF ABLUTIONS, WORK PLACE INSTALLATIONS</b>			
e.g. factories commercial office	wc/urinal basin kitchen sink (coffee service area only)	number of employees per shift x number of shifts	25
Where canteen facilities provided for kiosk meals, e.g. pies, pastries, sandwiches	kitchen sink		
Where plated meals provided e.g. hot/cold meals prepared on site	kitchen sink dishwasher	as above	10
<b>WINE TASTING</b>			
	wc/urinal basin kitchen sink glass washer	average daily number over 7-day period	5

## A.7. Conversion Factors

1 pound = 0.45359 kilograms	1 kilogram = 2.2046 pounds
1 inch = 2.540 centimetres	1 centimetre = 0.3937 inches
1 foot = 0.3048 metres	1 metre = 3.281 ft.
1 yard = 0.9144 metres	1 metre = 1.094 yards
1 yard = 36.00 inches	1 metre = 39.37 inches
1 mile = 1.609 kilometres	1 kilometre = 0.6214 miles
1 square inch = 6.452 square centimetres	1 square centimetre = 0.155 sq. inches
1 square foot = 0.093 square metres	1 square metre = 10.765 square ft.
1 square yard = 0.836 square metres	1 square metre = 1.196 square yards
1 acre = 0.405 hectares	1 hectare = 2.471 acres
1 acre = 43560 sq. ft. or 208.7x 208.7 ft.	1 hectare = 10,000 square metres
1 square mile = 259 hectares	1 square kilometre = 0.386 square miles
1 square mile = 2.59 square kilometres	1 cubic centimetre = 0.06102 cubic inches
1 cubic inch = 16.387 cubic centimetres	1 cubic decimeter = 0.0353 cubic ft.
1 cubic foot = 28,317 cubic centimetres	1 litre = 0.0353 cubic ft.
1 cubic foot = 6.23 Imperial gal.	1 cubic metre = 1.308 cubic yards
1 cubic foot = 28.3 litres	1 cubic metre = 35.3 cubic ft.
1 cubic yard = 0.765 cubic metres	1 cubic metre = 220 Imperial gal.
1 cubic yard = 168 Imp gal.	1 cubic metre = 1000 litres
1 cubic yard = 765 litres	1 litre = 0.220 Imperial gal.
1 Imperial gal. = 4.546 litres	1 litre = 0.264 U.S. gal.
1 Imperial gal. = 277.42 cubic inches	1 kPa = 0.145037 psi
1 Imperial gal. of water = 10 lbs.	1,000 mm pressure head = 9.807 kPa
1 U.S. gal. = 3.785 litres	1 kPa = 102 mm pressure head
1 U.S. gal. = 231 cubic inches	1 kPa = 0.335 ft. pressure head
1 Imperial gal. per sq. ft. = 49 litres per square metre	1 litre per sq. metre = 0.020 Imperial gal. per square foot
1 Imperial gal. = 1.20 U.S. gal.	1 Litre per sq. metre = 1 mm depth of <i>effluent</i> applied
1 U.S. gal. = 0.83 Imperial gal.	1 Imperial gal per sq. foot = 1.92 inch depth of <i>effluent</i>
1 foot pressure head = 304.8 mm pressure head	
1 foot pressure head = 0.434 psi	
1 psi = 2.301 ft. pressure head	
1 psi = 6.894757 kPa	



# APPENDIX B

## **Legislative Application of the Standard and Related Legislation**

The Alberta Private Sewage Systems Standard of Practice (Standard of Practice) (SOP) is developed by the Safety Codes Council (The Council) with advice from a diverse group of stakeholders. The stakeholders included in the development of this Standard are listed on Page iii of this Handbook. The development of the Standard of Practice also included reference to scientific papers and advice from scientists from across North America.

### **Legislative Authority**

The Safety Codes Act is the legislative authority for making regulations regarding *private sewage systems*. The Private Sewage Disposal Regulation AR 229/97, as updated by A/R 264/2009, sets out that this Standard of Practice is the rule in force in Alberta for *private sewage systems* as defined and limited by that regulation. One of the limits set out in that regulation is that the Standard of Practice is the rule for *sewage systems* serving developments that generate less than 25 cubic meters per day and where the entire system is located on the property. This regulation also requires that a system serving a *development* that generates more than 5.7 cubic meters per day be designed by a professional engineer or other person acceptable to the *Administrator*. The *Administrator* is the person delegated with the responsibility for the administration of specific aspects of the legislation by the Minister responsible for the applicable Act and Regulations. In this case that would be the Safety Codes Act and Private Sewage Disposal Regulation.

This Standard may also be used by Alberta Environment and Parks (AEP) in assessing the suitability of private *soil based wastewater treatment systems* in Alberta that fall under the jurisdiction of AEP; however, any such system is subject to additional requirements established by AEP with regard to impact on source waters and the receiving environment. AEP regulations come into effect when the *development* served by the *sewage treatment system* generates more than 25 cubic meters per day, serves more than 2 properties, or any part of the system crosses property lines whether collection, treatment or discharge to the environment.

Related Safety Codes Act legislation that applies to private sewage systems includes the Certification and Permit Regulation that sets out the qualifications required of persons installing *private sewage systems*. As well the Permit Regulation sets out that a permit is needed for the installation or changes to a *private sewage system*. A handbook to the Permit Regulation has been developed and is posted on the Municipal Affairs website.

Legislation under the Health Act also applies, specifically the Nuisance and Sanitation Regulation. The Nuisance and Sanitation Regulation includes requirements for separation distances between water wells and components of *private sewage systems*. These distances are the same as set out in the Standard of Practice. Other requirements, such as not creating a health hazard, are also set out in legislation under the health Act and they apply to *private sewage systems*. The scope and application of the Health Act is superior to the Private Sewage Systems Regulations 229/97.

All Alberta legislation including the legislation referenced here can be obtained from the Alberta Queen's Printer. Only a purchased copy obtained from the Queen's Printer is considered valid.

**Web site:** [www.qp.alberta.ca/laws\\_online.cfm](http://www.qp.alberta.ca/laws_online.cfm)

**Mailing address:**

Suite 700 Park Plaza

10611 98 Avenue Edmonton, AB T5K 2P7 Phone: 780-427-4952

---

## Explanations & Related Articles for Part 1 – Scope and Definitions

### Section B-1.1. General

#### **B-1.1.1.** Intent

##### **B-1.1.1.1.** Intent

(1) The Standard uses a numbering format defined in Article 1.1.4.4. and is consistent in each section regarding:

- Objectives and Design Requirements where the subsection ends with a number 1 such as in subsection 2.3.1;
- Prescriptive Requirements and Installation Standards where the subsection ends with a “2” as in subsection 2.3.2; and
- Requirements for Materials where the subsection ends with “3” as in subsection 2.3.3.

Knowing this helps the user navigate the Standard.

#### **B-1.1.2.** Scope

##### **B-1.1.2.1.** Application

(1) The application of this Standard does not apply to the sewer pipe leaving the *development* or the plumbing in the *development*. However, consideration of the plumbing in the *building* is required and the owner’s choice of plumbing fixtures in the *building* will affect the design of the *private sewage system*.

##### **B-1.1.2.1.** Application

(1)(f) Industrial *wastewater* may contain contaminants that are not contemplated by this Standard. Alberta Environment and Parks (AEP) regulate industrial process *wastewater*, so it is excluded from this Standard. This does not exclude from this Standard the domestic wastes from toilets, showers, and basins in the industrial facility.

##### **B-1.1.2.1.** Application

(1)(g) Regardless of the quality of the treated *wastewater*, the discharge of the treated *wastewater* to surface water is not allowed under this Standard. Discharges to surface water are regulated under Alberta Environment regulations and standards.

##### **B-1.1.2.1** Application

(2) This Standard applies to single-family dwellings and large commercial developments. Additional requirements are set out for developments discharging high strength *wastewater* or where peak daily flow exceeds 5.7 m<sup>3</sup> per day.

*Developments* exceeding 9 m<sup>3</sup> are subject to additional requirements (see Article 7.1.1.3).

See Section 2.4. for specific requirements; Article 8.1.1.9. for requirements regarding *groundwater mounding* prediction; and the Private Sewage Disposal Regulation for requirements for professional involvement in large systems.

#### **B-1.1.2.1. Application**

**(7)(b)** The note to this sentence is of particular importance. *Development* density and thus impact on the receiving environment along with the sensitivity to treated *wastewater* loading will vary substantially throughout the province.

In some cases, the limitations on design and use of private *sewage* systems will be limited by these factors or require additional design and performance standards to be met. Other legislation in Alberta may include the Land Use Planning Framework and the Cumulative Impact Management Act.

#### **B-1.1.5. Definitions**

##### **B-1.1.5.1. Interpretation of Words and Phrases**

**(1)** Terms and words that have specific meaning in this Standard are italicized anywhere they are used in this Standard.

##### **B-1.1.5.2. Defined Terms**

###### **Aquifer, Domestic Use (DUA)**

A DUA is ground water that can be pumped from the ground in a reasonable amount for use. Seasonally saturated fine textured soils are typically not in this class as the water in the ground and rate of recovery into a well through fine textured soils would not provide an adequate volume of water for any use.

###### **Biochemical Oxygen Demand (BOD<sub>5</sub>)**

BOD<sub>5</sub> is a key indicator of *wastewater* strength. The higher the number, the higher the strength of the *wastewater*. This measure is typically applied to raw *sewage*. cBOD<sub>5</sub> is typically used as a measure of *effluent* (treated *wastewater*) strength. (See definition of cBOD<sub>5</sub>)

###### **Carbonaceous Biochemical Oxygen Demand (cBOD<sub>5</sub>)**

The key difference from BOD<sub>5</sub> values is that the cBOD<sub>5</sub> value excludes the measure of oxygen needed by bacteria to change ammonia to nitrate.

###### **Clearwater Waste**

The discharge from a drinking fountain is an example. This definition is taken from the Plumbing Code adopted in Alberta.

###### **COLE (Coefficient Of Linear Extensibility)**

The *COLE* value expresses the amount of shrink – swell in a *soil* sample between being wet and dry. A high percent of change between wet and dry can indicate a problem *soil*. If the difference between wet and dry *soil* is substantial, it will cause the macro pores between peds (the *structure* of the *soil*) to close as the *soil* becomes wet from applied *effluent*.

###### **Complex On-Site Wastewater Treatment System**

A *wastewater system*, including any tank, pre-treatment, treatment plant, treatment method, post treatment or *soil* based dispersal/disposal. The following points, but not limited to, can be considered when making a determination of a complex system:

- Raw *wastewater* strength that exceeds *typical wastewater* strength as defined in the SOP.
- Has *soil* properties, layers, or profiles which have characteristics as shown in the restrictive layer definition of the SOP.



- Is located or will be located or near sensitive receiving environments as defined by the SOP.
- Have or will have cumulative effects due to proximity of other *soil* based dispersal systems or as designated by the authority having jurisdiction.
- Has a strength and flow volume variation from residential or *typical wastewater* strength and flow as defined in the SOP.
- A system or combination of systems which the authority having jurisdiction deems as a complex system.
- Any design considerations that are outside the scope of the SOP such as a combination of a *soil* based system and a *holding tank* to accommodate site restrictions would be considered a complex project and require a variance.
- Systems intended to be constructed on fill material regardless of the fill material and the fill material does not exceed the limits as defined in the SOP.
- New technologies not recognized in the SOP that require a variance issued by the *Administrator of Private Sewage*.
- Systems that require disinfection.
- Systems that require nutrient reduction regardless of the level of nutrient reduction, required by the SOP or the authority having jurisdiction.
- Systems intended to service more than 1 use on a common site or sites under separate title. (i.e., a home with 3.1 m<sup>3</sup>/day and a second home with a peak flow of 3.1 m<sup>3</sup>/day constructed on the same parcel).
- Communal systems on the same property regardless of peak daily flow rate.
- Designs for systems to be installed on lots smaller than 0.4 ha. In SAR unless the design is a holding tank only.
- Systems that will service public infrastructure.

### Consistence

Methods of determining *soil consistence* can be found in the Canadian System of Soil Classification. Moist soils characterized as very firm or firmer *consistence* are not well suited to *private sewage treatment systems*.

### Distribution Lateral Pipe

Pressurized piping is perforated by drilling orifices in the pipe of a *diameter* specific to the design and spaced at intervals selected by the designer within the constraints set by the SOP.

### Effluent Hydraulic Linear Loading

This is an important aspect of the soils capability to allow the horizontal movement of the added *effluent* through the *soil* so it does not surface.

### Effluent Line

The pressure piping delivering *effluent* to a *soil based treatment system*.

### Effluent Sewer

A pipe relying on gravity for the movement of *effluent*. It is not under pressure.

### Field Capacity

If the amount of water in the *soil* is more than its *field capacity*, it becomes saturated, and the flow through the *soil* will be predominantly saturated flow.

### Grade

The *grade* of the *soil structure* significantly affects the movement of water through the *soil*. It is a very important characteristic.

### Groundwater Mounding

Typically arrows showing the slope on a drawing will go from the high ground to low ground and show the *grade* of the slope in percent. Groundwater may follow the direction of a ground slope or it can also flow in the opposite direction.

### Groundwater Under the Direct Influence of Surface Water (GWUDI)

An example is an alluvial aquifer. If a recoverable *water source* is not separated by an impermeable geologic barrier that exists between surface *infiltration* and the groundwater it is likely classified as a GWUDI. For more detailed classification criteria see Alberta Environment publication, Standards and Guidelines For Municipal Waterworks, Wastewater and Storm Drainage Systems, where criteria for determining a GWUDI is set out in Section 1.2.1.4. of that document.

### LFH At-grade system

The forested area cannot be created prior to the installation of an *LFH At-grade system*. An existing LFH layer must be present in the *soil based treatment area*. (See Article 8.6.1.4.)

### Lift Station

*Lift stations* are often used to lift the *sewage* to a packaged treatment plant that must be installed at a shallow depth to facilitate servicing. Although *lift stations* generally do not provide any level of treatment that may differ in some cases. *Lift stations* are also used to lift *wastewater* to an elevation that can then discharge into a municipal *wastewater* collection system.

### Limiting Condition

The condition(s) found in the *soil* profile within the depth of *soil* that will most significantly affect the sizing and design of the *system* is considered the limiting design condition in the *soil*. This differs from a restrictive layer where the hydraulic conductivity is near zero or highly permeable horizon.

### Mobile Soil Water Content

*Field capacity* minus hygroscopic water content equals mobile water content of the *soil*.

### Mottling

This characteristic of the *soil* indicates sustained or periodic saturation of the *soil*. This picture shows *gleyed* and *mottled soil*.



Photo Credit: Onsite Installer; Oct. 2009 issue, More About Soils.

### Particle Size Analysis

The particle *size* distribution (percentage of sand, silt and clay) is what determines the *soil texture classification*. For sandy soils it is necessary to determine the particle *size* distribution of the sand fraction of the *soil* to identify the range of sand from coarse sand to very fine sand.

### Percolation Test

The percolation test cannot be used on its own as system design criteria. See Article 7.1.2.3. Research indicates that due to the variability in the results of this procedure and indirect relationship to long term *effluent* loading rates, this should not be relied on for the design of a *soil based treatment system*.

### Restricting Condition or Restrictive Condition

A *vertical separation* must be maintained above a restricting layer to the point at which *effluent* is applied to the *soil*. See Article 8.1.1.4. for required *vertical separation*. The restricting layer is the layer in the *soil* profile that essentially stops the downward flow of *effluent* whether by *soil* conditions or a layer in the *soil* that is already saturated at times of the year or continuously. Consideration must be given to coarse fragments which allow the *effluent* to move too quickly through the *soil* profile, reducing retention time required for treatment. *Soil* properties include, but not limited to:

- Fragipan or sodic horizon
- Fine textured *soil* with massive *structure*
- Bedrock
- Seasonally saturated *soils*
- Columnar structured *soil*
- *Water table*, groundwater, and perched *water table*
- Prismatic structured *soil* with a *soil consistence* or very firm or hard (wet) or hard or harder (dry), measured *soil* electrical conductivity greater than 4, SAR greater than 8, *COLE* greater than 3% or a *soil* dispersion test showing more than slight dispersion of the *soil*
- *Soil* with a *soil texture classification* of coarse sand, medium sand, loamy coarse sand or loamy medium sand with coarse fragments that exceeds 75%
- *Soil* with an *effluent hydraulic loading rate* from Table 8.1.1.10 of 0.00 L/m<sup>2</sup>/day (0.00 g/ft<sup>2</sup>/day)
- Where the *consistence* of the peds in a horizon are very firm or harder (wet/moist *consistence*) or hard or harder (dry *consistence*)

### Secondary Treated Effluent

*Secondary treated effluent* has a quality equal to or better than BOD<sub>5</sub> 25 mg/L and TSS 30 mg/L 80% of the time. See Table 5.1.1.1. for additional secondary treated levels.

### Septic Tank

See Section 4.2 with more information on septic tanks.

### Shore

See *water course* explanation for more discussion of the importance of this definition for the purpose of identifying a *water course* with example pictures.

### Smectitic or Smectitic soil

The soils mentioned in the definition can increase the risk of failure when *effluent* having a high SAR is applied. These are swelling clays and are not well suited to onsite *sewage* systems. For test methods that can assist in identifying these soils and the *soil's* susceptibility to dispersion when applying *effluent* with a high SAR. Information on the Emerson modified *soil* dispersion test is also helpful.

### Soil Infiltration Surface

This is the surface of the in situ (the existing *soil*) into which the *effluent* infiltrates. It does not include the surface of imported sand layers.

### Soil Separates

Sand particles are further broken down in to sub classes based on the *size* of the sand particle:

- Very Fine            0.05 – 0.10 mm
- Fine                    0.10 – 0.25 mm
- Medium                0.25 – 0.50 mm
- Coarse                0.50 – 1.0 mm
- Very Coarse        1.0 – 2.0 mm

### Soil Texture Classification or Texture

#### a) Sand

The hydraulic conductivity (*infiltration rate*) varies significantly depending on the amount of coarse to very fine sand in a *soil* sample.

##### i) Coarse sand

The allowed *effluent* loading rate on each of these sand subclasses is different. A sieve analysis of the sand fraction of a *soil* sample is needed to class the sand into one of these subclasses.

#### b) Loamy sand

The hydraulic conductivity (*infiltration rate*) varies significantly depending on the amount of coarse to very fine sand in a *soil* sample.

##### i) Loamy coarse sand

The allowed *effluent* loading rate on each of these sand subclasses is different. A sieve analysis of the sand fraction of a *soil* sample is needed to class the sand into one of these subclasses.

### Treatment Boundary Limits

The SOP sets out prescribed limits and distances in which treatment must be achieved but also provides for changes in the *treatment boundary limits* where justified.

### Vertical Separation

See Article 8.1.1.4. for the required depth of *vertical separation*. The graphic below shows the concept as applied to a *treatment field* trench. It shows the *vertical separation* is measured from the *soil infiltration surface*. This concept is applied to all systems.

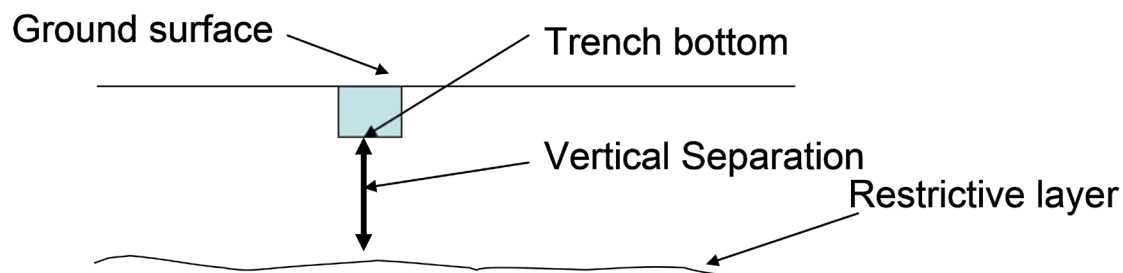

### Water Course

The definition of a *shore* is critical in defining a *water course*. For example, a roadside ditch meant to manage *storm water* is not a *water course*. The following text and photos help clarify the interpretation of *water course*.

The SOP requires a minimum separation distance between a *water course* and a *private sewage system*. Clearly applying the definition of *water course* is important in deciding where a *sewage system* can be placed. Identifying water courses is not always straightforward as there is often no water flowing at the time of the site investigation. The features described in clause d) are significant in identifying a *water course*. Important in the application of this definition is recognizing the change or absence of vegetation. The consideration of the definition of *shore* helps identify a *water course*. A *water course* of concern that affects the allowed location of a *private sewage system* will have an identifiable *shore*.

*Shore* means the edge of a body of water and includes the land adjacent to a body of water that has been covered so long by water as to wrest it from vegetation or as to mark a distinct character on the vegetation where it extends into the water or on the *soil* itself.

The 3 photos below assist in identifying a *water course*.



In this photo, a *shore* cannot be clearly identified in this gully. There is likely a period during rainfall or spring snow melt that water flows through this area so it is not a suitable location for a *sewage system*. However, water does not flow through often enough, based on the absence of a definable *shore*, to class it as a *water course*. This is not a *water course* as intended in the definition used in the SOP that requires a minimum separation from the *sewage system*.

The 2 following photos show a watercourse on a property different than shown above. Both photos below are taken from different perspectives on the same property. There is a defined *shore* or area where the vegetation is wrested away in the first photo and a dominance of vegetation typical of a watercourse is evident in the second of these 2 pictures. The large constructed culvert helps confirm the significance of the *water course* but is not needed for the determination of a *water course*.



**Water Well**

Separation distances need to be maintained to water wells. However, some wells may simply be monitoring wells not intended for the withdrawal of water; these wells do not require the separation distance specified for water wells.

Monitoring wells are required on some systems to monitor the impact the *sewage* system has on unconfined groundwater below the system so action can be taken if an unacceptable impact is identified. See Article 2.4.1.9. Sentence (2) for further details.

Note there are 2 classes of water wells that require separation distances that are different: private (general water wells) and licensed municipal water wells. These wells are licensed by Alberta Environment and Parks; they serve communal multi lot developments and larger developments that serve the public. Small private water wells are generally not licensed by Alberta Environment.

**Working Capacity**

Not included in the *working capacity* volume is a chamber in a tank that is used for dosing of *effluent*. See Section 4.2. for more information on *working capacity*.

## Explanations & Related Articles for Part 2 – General Requirements

### Section B-2.1. General System Requirements

#### **B-2.1.1. General System Requirements – Objectives and Design Requirements**

##### **B-2.1.1.2. Objectives and Design Requirements Based on Peak Flow**

(1) Subsection 2.2.2. sets out methods of and requirements for determining flow from a *development*. Some design requirements are specific to large volume systems as in Section 2.4.

##### **B-2.1.1.3. Objectives Achieved Within Treatment Boundary Limits**

(2) The system design must ensure any *effluent* that may migrate toward the surface is treated to the quality stated in clause (a) and (b) before coming to within 3 inches of the surface to limit the risk of direct contact with *wastewater* pathogens at the surface of the ground.

##### **B-2.1.1.4. Design Considerations**

(1)(c) *Groundwater mounding* is considered in a design by applying *linear loading* considerations, or by a detailed assessment of the site and modeling of *groundwater mounding* potential – See Article 8.1.1.9.

##### **B-2.1.1.6. Effluent Filters**

(2) During events of high *wastewater* flow through the system, particulates may be carried through to the dose chamber. The filter provides valuable protection to the downstream *soil* component.

##### **B-2.1.1.7 Groundwater Infiltration**

(1) *Groundwater infiltration* into a system can quickly overload the system, causing a failure.

#### **B-2.1.2. General System Requirements – Prescriptive Requirements and Installation Standards**

##### **B-2.1.2.1. Site Suitability and Use of Holding Tanks**

(1) To determine that a site has a location and conditions suitable for a *soil* based onsite *wastewater* treatment system an evaluation of the site as set out in Part 7 must be completed.

##### **B-2.1.2.6. Prohibited Wastes and Substances**

(1)(h)2 A water softener that uses sodium chloride as a regeneration agent may cause problems for a treatment and dispersal system. The sodium chloride will increase the SAR of the potable water used in the *building* fixtures and thus the *wastewater* entering the *onsite sewage treatment system*. The increased sodium is not a result of only the backwash water from the softener; the softener puts sodium into the water used in the *building* plumbing fixtures. The softener works by exchanging sodium into the water while removing calcium and magnesium found in the hard water. The removed calcium and magnesium is discharged in the regeneration waste of the water softener along with some excess sodium used in the regeneration process. Redirecting the regeneration water will not avoid the sodium being sent into the



*sewage* system as it is already in the water used in the *building*. If a water softener must be used, a softener that uses Potassium Chloride can avoid the problems of a sodium based softener. Also, avoid the installation of water softeners that automatically backwash at pre-set intervals of time rather than automatically by measuring water volume used. Softeners that regenerate based on time intervals regardless of the amount of water processed will discharge unneeded volumes of water and concentrations of salt into the *sewage* system.

This consideration is not exhaustive and other conditions may impact the system design.

## Section B-2.2. Wastewater Flow and Strength

### B-2.2.1. Wastewater Flow and Strength – Objectives and Design Requirements

#### B-2.2.1.1. General

(1) Some facilities produce a wide range of flow volumes and *wastewater* strength. The design needs to consider and address this fluctuation by employing a method of flow equalization.

#### B-2.2.1.4. Peak Wastewater Flow for Design

(1) Onsite systems are significantly impacted by peak flows that occur. Because onsite systems serve individual developments, there is very little averaging of flows that are seen in larger municipal systems.

#### B-2.2.1.4. Peak Wastewater Flow for Design

(2) In addition to taking daily meter readings over 30 days, consideration must be given to the occupancy loading at the time of the meter readings. If the *development* was being used significantly under capacity during the time of the meter readings the resulting flow volume would not properly represent flow at high occupancy. For example, if meter readings were taken at a community hall during a 30-day period when no events were held, the measure would not be representative of flows. In justifying the flow data collected, the designer needs to also consider and document the occupancy load of the *development*. This scenario could also apply to residential developments. If flow is metered in a 4-bedroom home that only has 2 occupants, the measured flow volume would not reflect the potential occupancy of the home.

#### B-2.2.1.5. Consideration of High Flow Fixtures

(1) Use of the tables must also consider the *development* may include fixtures that may use more water than found in a typical installation. This required consideration is set out in Article 2.2.1.5.

An example of high volume fixtures is found in many high-end homes that are using fixtures such as multi-head showers or large fill and drain soaker tubs or hydro massage tubs that affect *wastewater* flow volumes. Industry representatives report that some showers installed in homes may discharge 15 to 20 gallons of water per minute, compared to the 2 or 3 gallons per minute expected of a typical shower. This is a 5 to 10-fold increase in the amount of water flowing through the system from such a fixture. Some homes include large soaker tubs or hydro massage tubs that contain much more water than a typical bathtub. A typical bathtub may hold as much as 75 gallons of water. Large soaker tubs may hold 2 to 3 times as much as a typical bathtub.

While creating additional volume discharged to the *private sewage treatment system*, fixtures such as soaker tubs, hydro massage tubs, and high flow showers create a large volume instantaneous flow through the

*sewage* system. This causes the wash through of suspended solids from the *septic tank* or treatment plant into the *soil-based treatment system* that was not contemplated in the design and will likely create failures. Without specific design in the system to deal with this instantaneous flow, the system will be compromised. Consider the design flow of a 4-bedroom home estimated at 2040 litres (450 gallons) per day. The discharge of a soaker tub holding approximately 3 times the volume (1020 litres (225 gallons)) of a typical tub (340 litres (75 gallons)), the volume is discharged within about 10 minutes. This is half the daily (24-hour) design flow moving through the system in 10 minutes.

Article 2.2.2.3 of the standard sets out that where high water use fixtures are installed in the *development*, the system design must consider this additional flow. This article includes a table that requires added flow volumes be considered in the design to address fixtures that can cause increased flow through the system. The most effective way of managing instantaneous flow from fixtures is to include flow equalization capacity in the system so that these brief periods of high flow can be absorbed and then delivered through the treatment system over a 24-hour period.

#### **B-2.2.1.6. Consideration of Water Conservation Fixtures**

(1) System design capacity cannot be reduced when using water-conserving fixtures as the reduced water flow will increase the *wastewater* strength requiring sufficient design to handle the increased strength; however, water-conserving fixtures are beneficial to *private sewage systems*. See Article 2.2.1.6 regarding consideration of water saving fixtures and Article 2.2.2.4 regarding flow estimates with water saving fixtures. The reduction in water that needs to be returned to the environment through the *soil* can reduce the risk of failure and even result in improved treatment in the *soil*. Treatment in the *soil* can be improved because with less *effluent* discharged to the *soil*, the retention time of the *effluent* is extended in the effective treatment zone below the *soil-based treatment system*. Although treatment retention time within the *soil* is increased, the total *organic loading* applied to the *infiltration* surface remains the same when the *system infiltration* surface is not reduced in area so the formation of a biomat will be just the same as if water conserving fixtures are not used. Installing water conserving fixtures in a *building* with an existing *sewage* system will not harm the *sewage* system. It will help the system even though an increase in the concentration of the *wastewater* will occur. This is because the system was initially designed for the total loading of the waste carried in the water.

Less water being used as a result of water saving fixtures does not directly relate to allowing a reduction of the *size* of the treatment system. Treatment of the *sewage* is directed at removing the waste and constituents of concern from the water. When low flow fixtures are used it results in less water volume into the *system* but not less waste. With less water but the same amount of waste, the concentration of waste in the water increases. Although the concentration of waste increases, the mass loading (total amount of waste material) has not increased. *Typical wastewater* strength is expected to be 220 mg/L BOD<sub>5</sub>, 220 mg/L TSS and 50 mg/L oil and grease at the peak *wastewater* flow volumes set out in the tables of the Standard. If water use is decreased by 20% there will be a corresponding increase in concentration of BOD<sub>5</sub>, TSS and oil and grease. Because the amount of waste in the water is not reduced, the *size* of the system should not be reduced. The same capacity is needed to treat the waste in the water. Article 2.2.1.6 requires the increased *sewage* strength caused by low flow fixtures to be considered in the design. Article 2.2.2.4 sets out that where low flow fixtures are used, and the prescriptive requirements of the standard are used to determine sizing of the system, the flow volume used for design shall not be reduced from what is set out in the tables for determining flow volumes unless the increased strength is addressed by the design. By maintaining the design based on the peak flow set out in the Standard the system will be able to handle the increased strength of the *wastewater*.

### B-2.2.1.7. High Variable Flow Volumes During the Day

(1) See Article 2.2.2.3. for prescriptive requirements and see Article 2.2.2.5. for flow equalization requirements in the system.

## B-2.2.2. Wastewater Flow and Strength – Prescriptive Requirements and Installation Standards

### B-2.2.2.1. Influent Wastewater Quality

(2) Depending on the strength of the *effluent*, the allowed *effluent* loading rates on *soil infiltration* surfaces will vary. The *effluent* loading rates set out in Table 8.1.1.10. demonstrate this. In Table 8.1.1.10 there are 2 columns setting out allowed loading rates based on *effluent* quality; 1 column for *effluent* strength between 30 and 150 mg/L cBOD<sub>5</sub> and 1 column for *effluent* strength of less than 30 mg/L. These are columns 4 and 5 of that table.

In addition to the volume of *wastewater* generated by a facility, the strength of the *wastewater* also needs to be considered and is just as important as volume.

*Wastewater* strength can affect the capacity required of both initial components and final *soil* based treatment component design. This is referenced in Article 2.2.2.1. Sentence (2).

*Developments* must be reviewed at the time of design to determine characteristics that may cause an increase in *wastewater* strength. The Standard requires that a projection of *wastewater* strength must be included in a design. This projection needs to be backed up by the findings of the review of the *development*. Either there is nothing that would increase strength, or there are characteristics that will increase strength and determine the anticipated raw *wastewater* strength.

A prescriptive requirement in Article 2.2.2.6 regarding the use of garbage grinders that are used under the kitchen sink requires an increase of 30% in the *wastewater* strength along with increased storage capacity for sludge of 50%. This is due to the additional waste being put down the drain but also due to the waste being food that has not been processed by humans. Food that has been consumed by humans has been digested and much of it taken up by the body. What's left after digestion is less than the raw food product. The undigested food puts a much larger *organic loading* into the system that the microorganisms must consume. The Standard also sets out methods for projecting *wastewater* strength in Article 2.2.1.3. and in Article 2.2.2.1. Sentence (3) of the standard that sets out minimum *sewage* strength for design for restaurants, work camps and campgrounds that are common developments served by *private sewage systems*. Sentence (3) of this Article requires the highest value of either the table, other published information, or the measured strength from similar developments be used for design purposes. A note is included in Table 2.2.2.1 that is very important. This note identifies that the values set out in the table are a minimum design value and that actual values are often higher. It is the responsibility of the designer to ensure adequate consideration of the *wastewater* strength.

Article 2.2.2.1. Sentence (5) requires that where the anticipated *wastewater* strength will exceed *typical wastewater* strength the *effluent* discharged to the *soil based treatment system* must be sampled and tested to ensure the system has achieved the quality intended in the design. This sampling should be undertaken when the system has stabilized. Although not specified by the Standard, sampling should be done more than once at appropriate intervals to determine the *wastewater* quality. One sample in a point in time is hard to use as defensible confirmation that the system has achieved the intended outcome. While sampling is needed to confirm compliance with the Standard, sampling is also important to identify problems that can occur if the

system is not serviced properly or conditions change resulting in higher than anticipated *wastewater* strength that can cause a failure of the *soil-based system*.

#### **B-2.2.2.1. Influent Wastewater Quality**

(3) This Article requires that the highest strength determined by any of the 3 methods set out here is used for design. The values set out in Table 2.2.2.1. are minimum values and should be used cautiously by a designer. See note in Table 2.2.2.1. The designer must provide evidence that the *wastewater* strength used in the calculations has been verified by providing information on the occupant load and the purpose of the *building*. The Safety Codes Officer can also accept published information or measured *wastewater* strength from similar developments and/or combination thereof.

#### **B-2.2.2.1. Influent Wastewater Quality**

(5) The methods used to collect *wastewater* samples are critical to obtaining good results from the testing lab. While the lab has set procedures to test the samples, if the sample collected was not representative of the raw *wastewater* or the *effluent*, or the sample was not preserved as required the result from the lab will be meaningless.

There are 2 general types of samples: a grab sample and a composite sample. The grab sample takes a measure in a single spot in a single point in time. A composite sample is a sample collected that represents flow over a period of time; these are often 24-hour composite samples. Composite samples take a small sample at regular intervals throughout the day and then are combined to provide the composite of the day's flow. Often each sample during the day is of differing volumes to adjust for the flow rate at the time to give a flow proportional composite sample.

In an onsite *sewage* system, it is relatively easy to get a composite sample for at least a part of the day as *effluent* is stored in the dosing tank for a period of time before being discharged. However, obtaining a composite of the raw *wastewater* is not easy in an onsite system. Samples from the first compartment of a *septic tank* will likely be of *wastewater* that has had some time for settling, as the appropriate place to sample from is below the scum layer and above the sludge layer. Also any grab sample from the inlet sewer line to the tanks will be a strict grab sample and can vary significantly in strength depending on the source of the flow at the time. Numerous samples should be taken in this case and mixed together to get the best representation possible for the *sewage*.

When obtaining samples, consult the lab that will do the testing to get advice on sampling procedures, suitable containers for storage, stabilizers that must be added to the sample, temperature for the storage of sample during transport to the lab, and timelines for getting the sample to the lab.

#### **B-2.2.2.2. Peak Daily Wastewater Volume**

(1)(a) Table 2.2.2.2.A is supplemented with a list of typical fixtures and the assigned fixture unit load. This information can be used to total the number of fixture units in the house. Although floor drains are listed, they should only be included when it is expected they will normally receive *wastewater* flow. A floor drain in the basement, for example, has the sole purpose of draining water when something goes wrong such as a leak in the water heater. The note to the fixture unit loading values indicates floor drains that are for emergency use do not need to be included in the total fixture unit loading that will be used in determining the need to increase the peak flow volume.

### B-2.2.2.3. Additional or High Capacity Fixtures

(1) See Table 2.2.2.2.A. for additional volume to be added based on the cumulative FU rating of fixtures installed in a residence.

Article 2.2.2.3 of the standard sets out that where high water use fixtures are installed in the *development*, the system design must consider this additional flow. This article includes a table that requires added flow volumes be considered in the design to address fixtures that can cause increased flow through the system. The most effective way of managing instantaneous flow from fixtures is to include flow equalization capacity in the system so that these brief periods of high flow can be absorbed and then delivered through the treatment system over a 24-hour period.

### B-2.2.2.5. Flow Variation and Flow Equalization

(1) Typical daily *wastewater* flow patterns for many developments create a diurnal flow pattern (meaning there are 2 significant flow peaks during a day). In a diurnal flow pattern, flow is typically concentrated in the early morning, late in the day at suppertime, and in the evening. This is anticipated in the requirements set out in this Standard. However many developments may have flow volumes that are very concentrated during specific times of the day due to the characteristics of the *development* of use of the *development*. The potential for flow variation needs to be identified at the design stage. Where it is expected the *development* will produce *wastewater* volumes that vary significantly over the day, or even from day to day, this needs to be addressed in the design by including flow equalization.

Article 2.2.1.4. sentence (4) and Article 2.2.1.7 set out requirements for equalization when flow varies considerably from day- o day and flow variation during the day. When flow varies significantly from day to day, the total peak flow over a period of days can be equalized using a large *equalization tank*. This will result in a lesser amount being discharged through the system on the very high flow days and increase the amount discharged to the system on low flow days. This equalization effect will improve the performance of the system and allow some parts of the system to be smaller than if designed for the maximum flow on one day. Article 2.2.2.5 sets out the capacity required for flow equalization and controls required, however the intent of this article is to address situations where the flow varies during the day. When trying to equalize flow from a facility that varies in flow volume from day to day and substantially over the week, careful calculations are needed to ensure sufficient capacity. This is particularly true when days of high flow volumes may be the 2 days of the weekend and then the *equalization tank* is intended to allow discharge to catch up during the following 5 days.

When flow varies significantly during the day it is important to equalize the flow so that the treatment system is not overloaded due to high instantaneous flow. In homes, high instantaneous flow can occur due to a large volume tub or high flow showers. In commercial applications, a motel or hotel is an example of where flow equalization is needed. Typically, in motels and hotels, the majority of the flow occurs in the morning from 6 am to 12 pm; that is, only a quarter of a full day. This high flow rate will overwhelm a system that is designed for the daily peak flow without recognizing that flow occurs during that short period of the day. An *equalization tank* is needed to store the daily flow and enable timed discharges to the *system* over the 24-hr period. Article 2.2.2.5 sets out the capacity of tanks needed to equalize flow and requirements for controls when addressing flow variations that occur during the day. This capacity as set out may not be adequate when flow volumes vary from day to day. Typically, the *equalization tank* is placed upstream of all other components in the treatment train. A pump in the *equalization tank* is used to discharge small amounts at a low flow rate to the downstream components using time-controlled discharges. During high flow, *wastewater* is stored in the *equalization tank*, and then the system catches up by continuing to empty the tank during low flow periods.

Equalization is used to control the frequency of dosing *effluent* to the *soil based treatment system* so that it is applied to the *soil* evenly throughout the day. This improves the treatment performance of the *soil* based treatment system substantially, by ensuring large demand *effluent* doses do not cause periods of saturated flow through the *soil* at times of high flow from the *development*. To provide flow equalization, the dosing tank is increased in *size* to provide capacity to store *effluent* and a timed dosing controller is used to control the frequency of *effluent* doses to the *soil based treatment system*. It should be recognized that if equalization is used upstream of all the treatment components, further equalization in the dose tank will be of little value.

## Section B-2.3. System Controls: System Flow Less than 5.7 Cubic Metres per Day

### B-2.3.1. System Controls: System Flow Less than 5.7 Cubic Metres per Day – Objectives and Design Requirements

#### B-2.3.1.2. Alarms Required

(2) Timed dosing systems use floats to activate or shut off a controller that is set by the designer to deliver a specific volume per dose at timed intervals. The benefit of timed dosing is that the system is less susceptible to overloading during periods of high *wastewater* flow. Preventing periods of overload and spreading the *wastewater* application evenly through the day to make more effective use of the treatment processes. The intent with all systems is to provide positive control of the *effluent* dose volume. This requires careful consideration of the elevations in the dose tank. The float is set to turn the pump on and off or activate the timed dosing. When timed dosing volume settings are exceeded by the flow generated, the time dosing control will set off an alarm. It is important this alarm not be taken out of service in the programming of the control. The information it provides the owner is important to ensure they appropriately react to the signal. This would include checking their water flow, silencing the alarm knowing it will return to normal when the guests that are creating the excess flow leave, or having a service person come to determine the problem and adjust the system if needed.

#### B-2.3.1.2. Alarms Required

(3) The alarm needs to be connected to a common well-used circuit (such as a kitchen light) that is not related to the treatment system and have a battery back up. Connecting the alarm to a dedicated power circuit is not desirable.

#### B-2.3.1.4. Mounting of Water Level Control Devices

(1) These control components must be mounted so they can be removed or adjusted without disconnection of other piping or components. Mounting the floats on an independent mast made of PVC piping achieves this. The graphic below depicts a simple mounting method for floats.

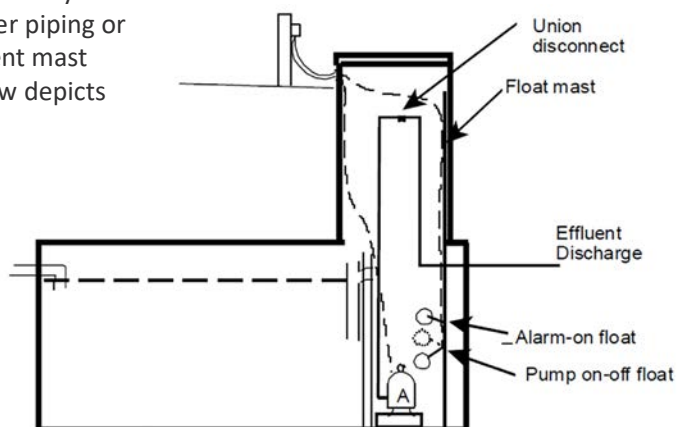

### B-2.3.1.5. Detection and Data Recording for Secondary Treatment Systems

(1) Systems that include secondary or better treatment prior to discharge to the *soil based treatment system* require a control system that will record operational data. Article 2.3.1.5 sets out specific functions and parameters for which the system control must capture data. This provides important information needed for the effective operation of the system. Clause (1)(c) of this article sets out that the system must record daily flow volumes. This requires the data captured by the control system enables the determination of the flow in any given 24 hr. period. Simply providing a total count of dose cycles and dividing over the number of days the data was collected is not acceptable, as it does not provide useful data on daily peak flows or significant changes in flow from time to time. This is critical information needed to optimize the operation to troubleshoot the system. When secondary or better treatment is included in the system there is a high degree of reliance placed on the performance of the system for treatment success and long-term operation.

## Section B-2.5. Piping

### B-2.5.2. Piping – Prescriptive Requirements and Installation Standards

#### B-2.5.2.3. Protection From Freezing

(1) See graphic below for ways to protect the pipe from freezing.

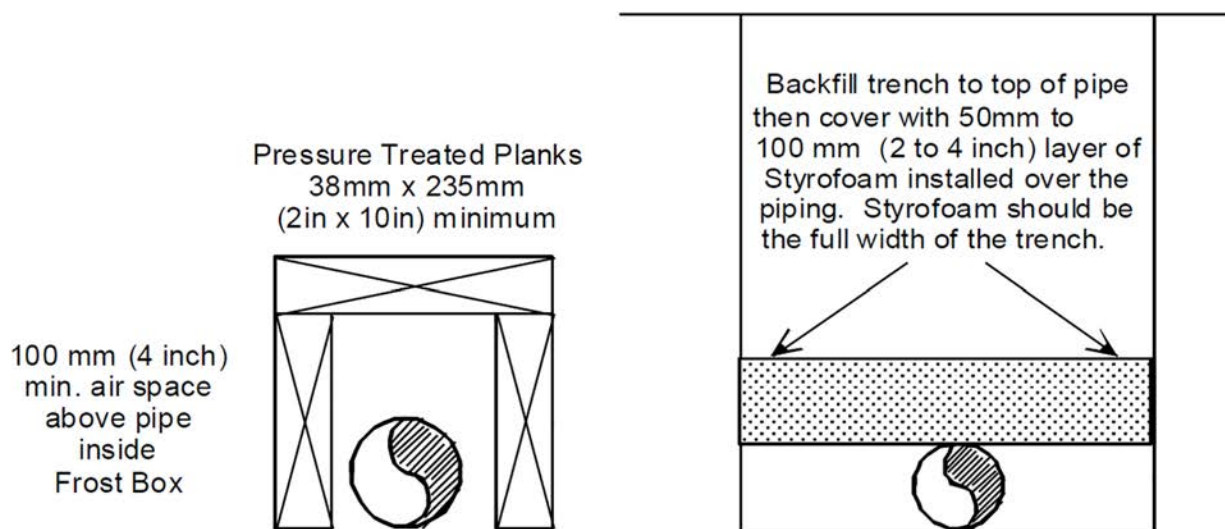

### B-2.5.3. Piping – Requirements for Materials

#### B-2.5.3.2. Piping in Gravity Applications

(1)(a) & (1)(b) The piping here is DWV. It is meant for gravity applications, is considered heavy wall piping, and is suitable for the 1800 mm (6 ft.) inlet and outlet connections to the tank. ABS cellular core pipe is not suitable for gravity application.

#### B-2.5.3.2. Piping in Gravity Applications

(1)(c) & (1)(d) This piping is thin wall sewer pipe, which cannot be used within 1800 mm (6 ft.) of a connection to a tank.

## Section B-2.6. Pressure Distribution of Effluent

### B-2.6.1. Pressure Distribution – Objectives and Design Requirements

#### B-2.6.1.1. General

(1) Certain system designs set out in the SOP require a *pressure distribution* system. *Pressure distribution* is required for:

- Application of secondary treated *effluent* (Article 8.1.1.8.(1))
- Certain *soil* textures (Article 8.1.1.8.(2))
- Raised *treatment field* (Article 8.2.2.11., Sentence (1), Clause (c))
- *LFH At-grade system* (Article 8.6.1.7.(1))

#### B-2.6.1.2. Orifice Discharge Volume

(1)(a) A squirt test could include collecting all the water discharged during a single dose event from the orifice that will get the water first and the orifice that the water squires from last. The amount of water collected from each should not differ more than allowed by this Article. The pressure head at the far end of the laterals should be recorded at the time of installation so comparisons can be made in years following. An increase in pressure may indicate plugging of orifices.

Distribution laterals at different elevations can present difficulties in achieving even distribution.

Pressure Distribution Laterals on a Slope – **squirt height varies** – make provisions to correct squirt height differences and the volume discharged per dose to each lateral.

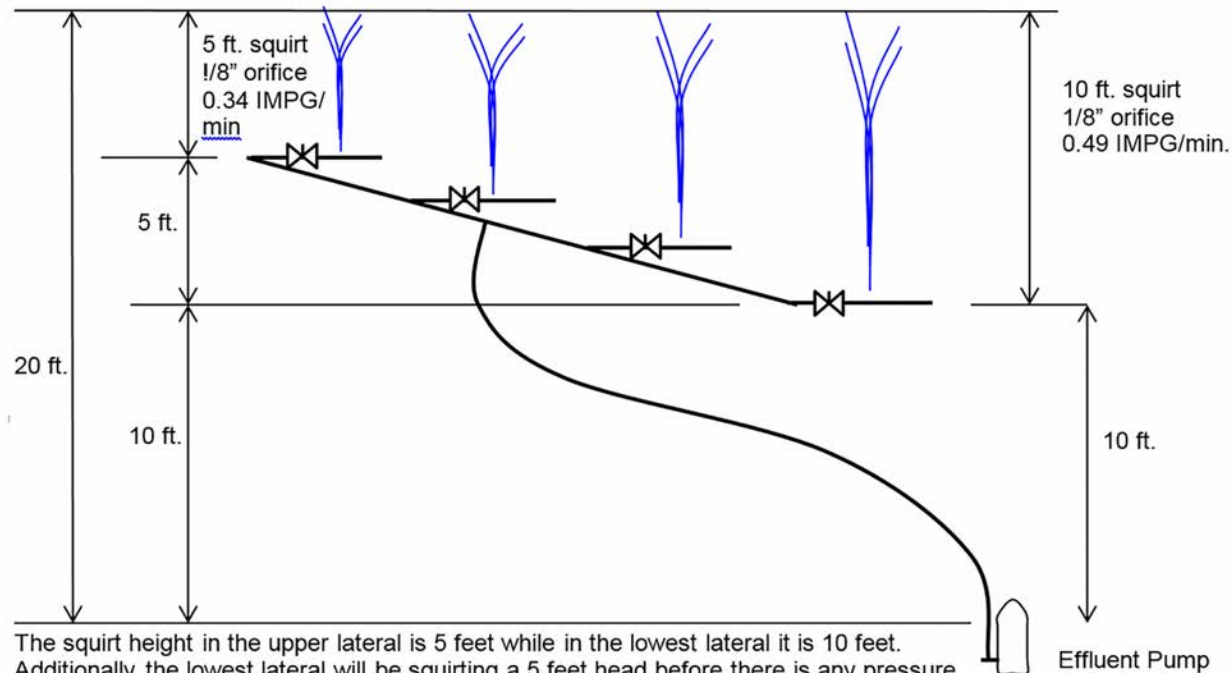

The squirt height in the upper lateral is 5 feet while in the lowest lateral it is 10 feet. Additionally the lowest lateral will be squirting a 5 feet head before there is any pressure at the upper lateral. The same difference will occur when the pump shuts off. Adjusting the balancing valves will equalize the pressure in each lateral once the entire system is pressurized but will not address the differences in squirt start and stop in the laterals,



### B-2.6.1.3. Effluent Pressure Distribution Lateral Pipe Objective

(1) An effective *pressure distribution* system will utilize the entire *soil infiltration surface* equally. Measuring the *soil* moisture in various location of the *infiltration* surface can quantify the objective has been met. A *pressure effluent* distribution system is a network of *pressure effluent* distribution laterals laid out over an *effluent infiltration* surface. Effective distribution of the *effluent* utilizes all areas of the required *infiltration* surface. This prevents saturation of some areas and underutilization of other areas of the *infiltration* surface. Systems using *pressure distribution* will provide better treatment of the *wastewater effluent*. *Pressure distribution* is required on some *soil* types (sandy soils) and when applying secondary treated *effluent*. An *effluent* loading rate factor may be allowed for *pressure distribution*. The following Articles set out where *pressure distribution* is required and where it may allow a reduction in *infiltration* area with the application of allowable loading rate factors: Articles 8.1.1.8 (required for secondary treated *effluent* and coarse textured soils); 8.2.1.8 (may allow reduction in *treatment field* area) 8.2.2.2 (required on coarse textured soils in *treatment fields*); 8.4.1.11 (*pressure distribution* required for *treatment mounds*); 8.6.1.7.1.

*Pressure distribution* is required for *LFH At-grade* type systems. The *pressure distribution* system must achieve the requirements outlined in Section 2.6 of the Standard of Practice. The purpose of a *pressure effluent* distribution system is to provide positive control of the amount of *effluent* applied over an *effluent infiltration* surface such as in a *treatment field*, *treatment mound*, *LFH At-grade*, intermittent sand filter or *re-circulating gravel filter* as set out in Article 2.6.1.1. The design of the system must result in the volume discharged from each orifice per dose event does not vary by more than 10% along the length of a lateral and not more than 15% throughout the entire distribution system. See Article 2.6.1.2 for this requirement. The objective of the design (see Article 2.6.1.3) is to effectively distribute the *effluent* so the *soil* moisture measured at a depth of 77 to 175 mm (3 to 7 inches) does not vary by more than 20%. If the design of the *pressure distribution* system follows the design requirements set out in the standard, it can be assumed this objective is met.

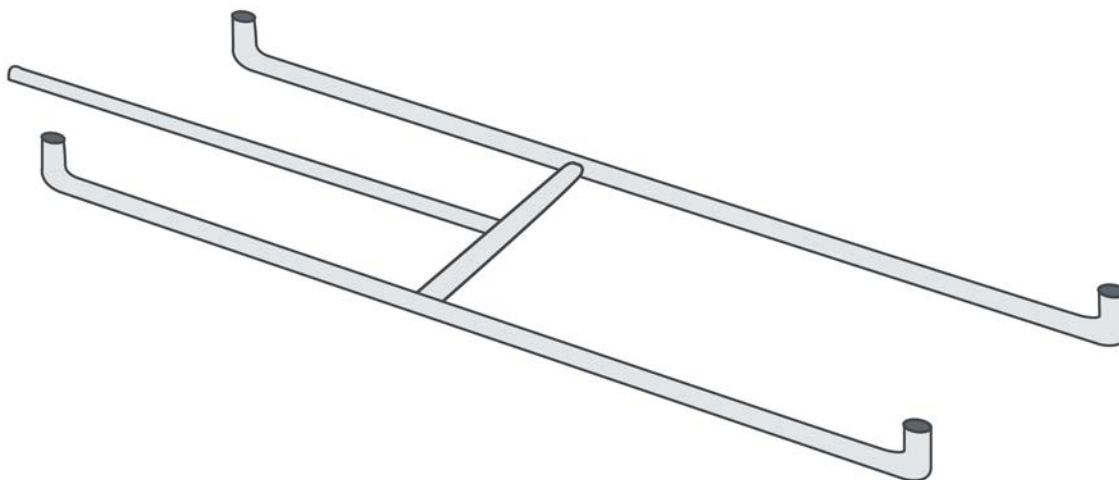

### B-2.6.1.4. Orifices Elevated Above Infiltration Surface

(1) Elevated orifices help prevent the drain back of *effluent* in the trenches when periodic ponding occurs in the trench. Drain back of ponded *effluent* can cause rapid pump cycling and draw *soil fines* back into the piping and dose tank. Supports to elevate the piping should be spaced not more than 1.2 m (4 ft.) apart to effectively prevent sagging of the pipe. A minimum elevation is specified above the *infiltration* surface in Article 2.6.2.6.

#### **B-2.6.1.5. Pressure Distribution Lateral System Design**

**(1)(b)** The purpose of this minimum flow velocity is to minimize the buildup of biological growth in the piping. See the A.1.C. series of tables for friction loss in piping.

High flow velocity in piping can result in extremely high pressures if a quick closing valve suddenly stops it. If no quick closing valve is downstream of the pump the 5 ft. per second velocity can be exceeded. The designer should provide justification for exceeding 5 feet per second of velocity.

### **B-2.6.2. Pressure Distribution – Prescriptive Requirements and Installation Standards**

#### **B-2.6.2.2. Orifices**

**(1)** Orifices that are in the top of the pipe are not as likely to plug as the ones in the bottom of the pipe. When used in chambers, pointing the orifice up helps spread the spray and does not result in a concentrated spray on the *soil* interface. The chamber acts as an orifice shield for upward-facing orifices.

### **B-2.6.3. Pressure Distribution – Requirements for Materials**

#### **B-2.6.3.2. Effluent Filters and Service Access**

**(1)** Careful consideration of the filter selected for this purpose is needed. It must effectively remove particles to less than 3.2 mm (1/8 in.) in size, provide effective service intervals and, if located downstream of the pump, the head loss through the filter must be considered in pumping requirements.

#### **B-2.6.3.3.**

**(1)** Pumps should be selected so that they are working in the middle third of the pump curve to ensure long life of the pump.

## Explanations & Related Articles for Part 3 – Holding Tanks

### Section B-3.1. Holding Tanks

#### B-3.1.2. Holding Tanks – Prescriptive Requirements and Installation Standards

##### B-3.1.2.4. Base for Holding Tank

(1) A solid base for any tank is imperative for its effective operation and to maintain its integrity so it does not crack or leak.

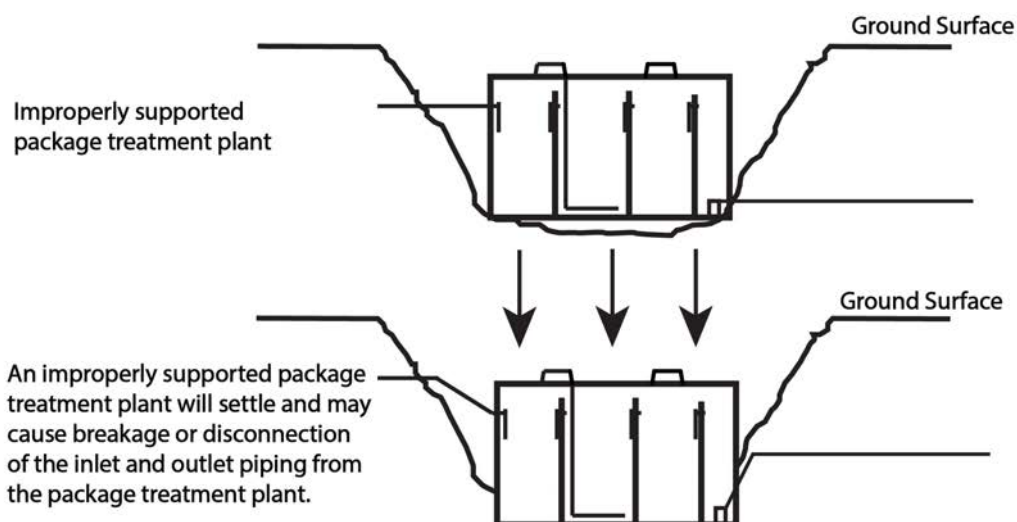

##### B-3.1.2.5. Insulation of Tank

(1) See insulation manufacturer literature for applications for below *grade* use.

## Explanations & Related Articles for Part 4 – Initial Treatment Components Primary

### Section B-4.1. Primary Treatment

#### **B-4.1.1.** Primary Treatment – Objectives and Design Standards

##### **B-4.1.1.1.** Effluent Treatment Quality

(1) This is the *effluent* quality expected from a *septic tank* when the *septic tank* is operating effectively and the strength of the raw *wastewater* entering the *septic tank* does not exceed the limits set out in this Standard. See Article 2.2.2.1. for anticipated strength of raw *wastewater*.

##### **B-4.1.1.1.** Primary Treatment Quality

(2) *Effluent* loading rates set out in this Standard for primary treated level 1 *effluent* rely on this quality of *effluent* being applied. See Table 8.1.1.10. for *effluent* loading rates. Higher strength *effluent* may cause a premature failure of the *soil* based treatment and *infiltration system* due to excessive biomat formation on the infiltrative surface.

##### **B-4.1.1.2.** Sludge and Scum Accumulation

(1) Sludge and scum accumulation rates for residences are set out in Article 4.2.1.1., Sentence (1), Clause (b), Sub-clause (i). For other types of *development*, Table A.6.A sets out sludge and scum accumulation rates.

## Section B-4.2. Septic Tanks

### B-4.2.1. Septic Tanks – Objectives and Design Standards

#### B-4.2.1.1. Working Capacity

(1)

## Septic Tanks

All septic tanks must be certified to the CAN/CSA B66 Standard and Labeled by the Certifying Body.

- Basic shapes of septic tanks;
- (a) Cylindrical, may be horizontal or vertical;
  - (b) Spherical,
  - (c) Rectangular.

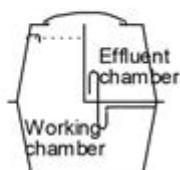

Single septic chamber "Syphon" type septic tank



Single septic chamber "Syphon" type septic tank

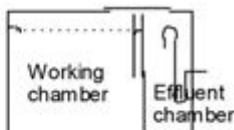

Single septic chamber "Pump" type septic tank

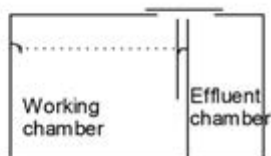

Single septic chamber "Pump" type septic tank

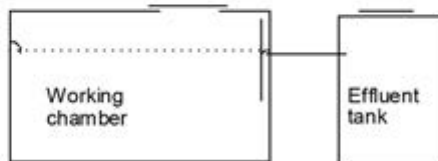

Single chamber type septic tank

- Basic Types of Septic Tanks:
- (a) Single septic chamber "Trickle Tanks",
  - (b) Double septic chamber "Trickle Tanks",
  - (c) Single septic chamber "Siphon Tanks",
  - (d) Double septic chamber "Siphon Tanks",
  - (e) Single septic chamber "Pump Tanks",
  - (f) Double septic chamber "Pump Tanks",.

- Basic septic tank materials;
- (a) Concrete
  - (b) Fiberglass
  - (c) Polyethylene
  - (d) Steel (rarely used)

Note: The manufacturer's model number designation of their septic tanks do not necessarily indicate the "Working Capacity" of their products therefore, caution must be exercised when selecting a septic tank. The working capacity of the tank must be included on the certification label required on the tank.

The required size of the septic tank set out in the Standard of Practice refer to the "Working Capacity".

Single or double septic chamber "Trickle Tanks" must be followed by an effluent dosing tank.

Septic Tank Configurations and Components

Two Compartment - Two Chamber  
"Pump or Siphon Type" Septic Tank

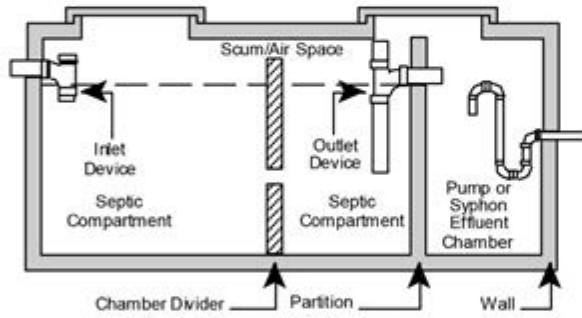

Two Compartment - Single Chamber  
Septic Tank

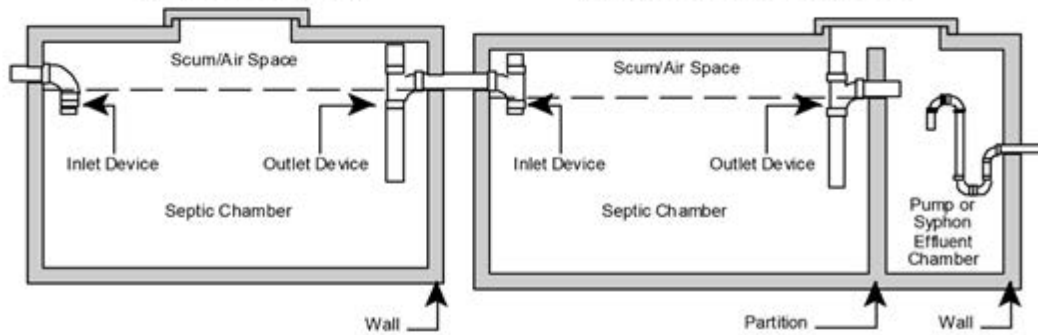
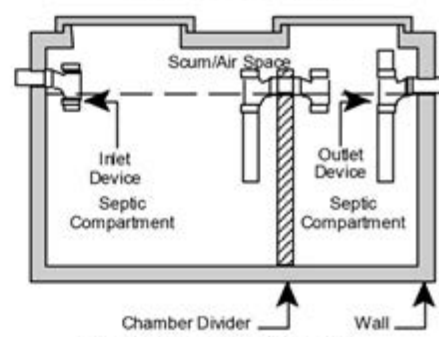

Single Compartment - Single Chamber  
Septic Tank

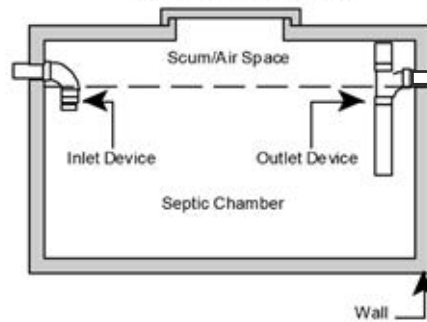

Independent Effluent Chamber  
Pump or Siphon Type

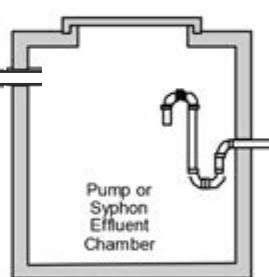

**B-4.2.1.2. Service Access**

(1) The available vacuum lift changes with the elevation above sea level. At Calgary's elevation, with 100 feet of hose attached, the limit is reached if the truck is parked about 1 story above the top of the tank. The vertical limit is about 27 feet when very little suction hose is needed. The lift distance is measured from the water in the tank to the water level in the truck's tank which rises as the truck fills.

**B-4.2.1.3. Infiltration/Exfiltration Prevention**

(2) The tank manufacturer needs to be consulted to confirm the tank's suitability to the site conditions it is installed in. Acceptable anti-floatation methods suitable for the tank must be used when required. In many cases, a stronger tank must be used to withstand the structural forces encountered.

**B-4.2.2.2. Minimum Working Capacity**

(1) More information on determining required *working capacity* of a *septic tank*.

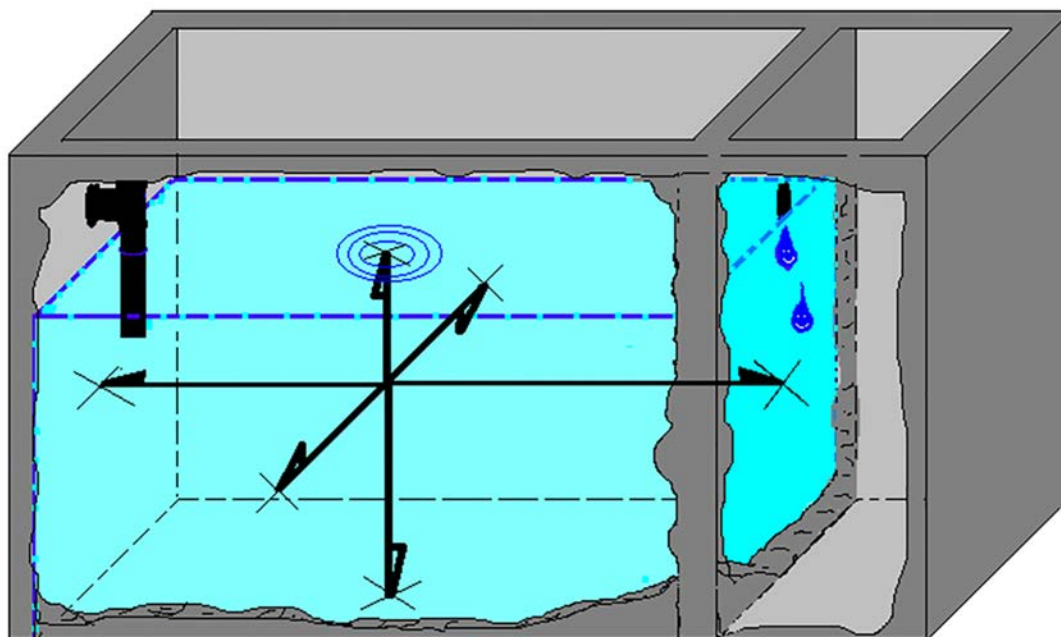

**WORKING CAPACITY** of a SEPTIC TANK,  
does not include: air space, siphon chamber,  
pumping chamber, or effluent chamber

B-4.2.2.7. Base for Septic Tank

(1)

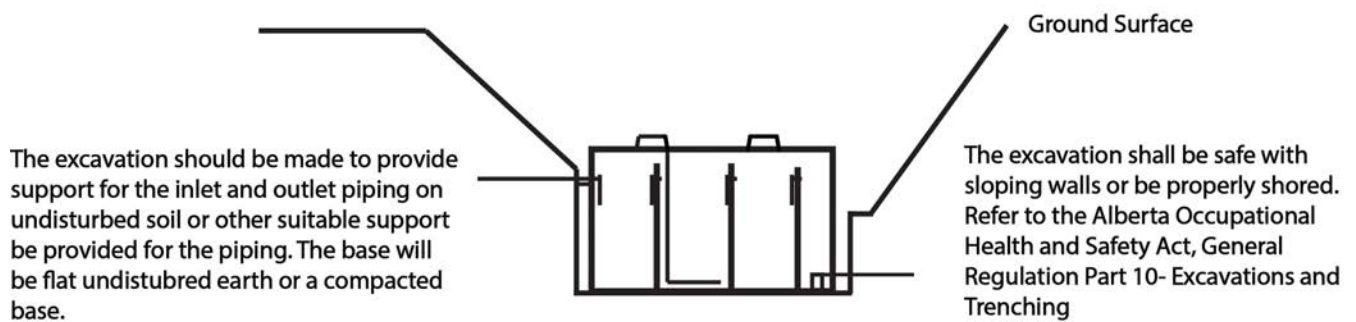
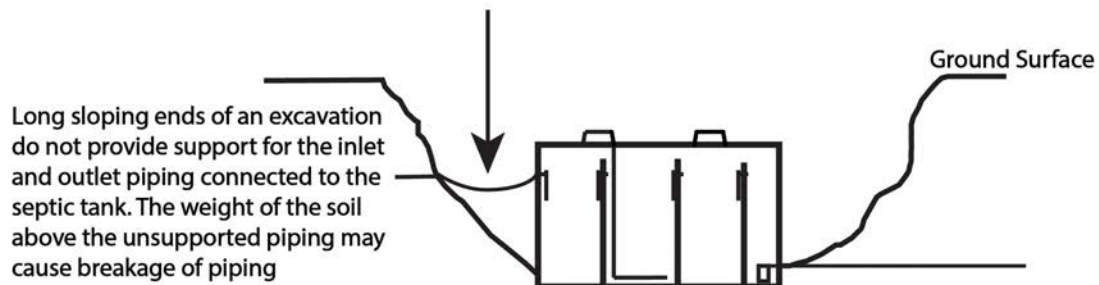
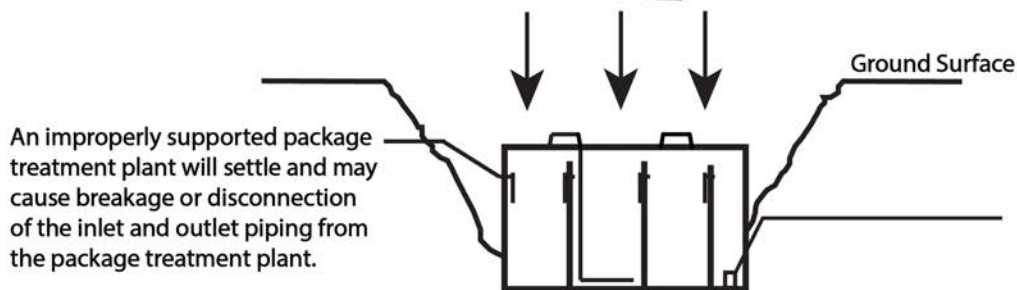



## Explanations & Related Articles for Part 5 Initial Treatment Components – Secondary Treatment

### Section B-5.2. Packaged Sewage Treatment Plants

#### B-5.2.1. Packaged Sewage Treatment Plants – Objectives and Design Standards

##### B-5.2.1.1. General

(2) See Section 6.2 of the Standard for requirements applying to settling tanks (pre-treatment tanks). The pre-treatment tank helps reduce sludge build up in the aeration chamber; manage instantaneous high flow rates and evens out the strength of *wastewater* entering the aeration chamber. The function of the pre-treatment tank provides for a more stable performance of the treatment plant resulting in a consistent *effluent* quality.

##### B-5.2.1.2. Treatment Capacity

(1) *Packaged sewage treatment plants* are aerobic treatment plants that use various methods to expose the *sewage* to oxygen, depending on their design. Increased levels of oxygen in the *sewage* provide the conditions needed for the establishment of large aerobic bacteria populations. These aerobic bacteria populations accelerate the decomposition of the suspended solids in *sewage*.

*Packaged sewage treatment plants* perform best when they are subjected to a constant and consistent volume and quality of *sewage*. It takes some time to initially establish a bacteria population suitable to the *wastewater* received so there is a balance between the bacteria population, the amount of organic load discharged to the *packaged sewage treatment plant*, which the bacteria use as food, and the amount of oxygen available to the bacteria to metabolize the organic load received. If there is a sudden increase in the amount of *organic loading* (BOD<sub>5</sub> and TSS), there may be a decrease in the quality of the *effluent* discharged from the *packaged sewage treatment plant* until the bacteria population increases to consume the increased organic load. In any installation, methods to equalize flow must be considered, and included in the design to prevent excess flow through the plant that may wash out the bacterial population, or go through so fast the bacteria do not have time to consume the *organic loading* of the *wastewater*.

During an extended holiday, a reduction in the bacteria population due to the lack of *sewage* that the bacteria use as food will occur. This may result in a decreased *effluent* quality when use resumes until the bacteria population increases again to match the volume and strength of the *sewage* discharged to the unit. Bacteria population can be maintained by providing alternative organic matter to the *system*, thereby providing an alternative food supply for the bacteria until normal *sewage* flow is again established.

##### B-5.2.1.5. Infiltration/Exfiltration Prevention

(2)(a) The tank manufacturer needs to be consulted to confirm the tank's suitability to the site conditions it is installed in. Acceptable anti-floatation methods suitable for the tank must be used when required. In many cases, a stronger tank must be used to withstand the structural forces encountered.

**B-5.2.2. Packaged Sewage Treatment Plants –  
Prescriptive Requirements and Installation Standards**

**B-5.2.2.1. Separation Distances**

(2)(a) Consult the manufacturer of the treatment plant for suitable odour control equipment and methods.

**B-5.2.2.1. Separation Distances**

(3)(b) Consult the manufacturer of the treatment plant for suitable odour control equipment and methods.

**B-5.2.2.2. Wastewater Strength**

(1) A *certified package sewage treatment plant* as identified in Article 5.2.3.1., used for the treatment of residential strength *wastewater*, may be able to treat *wastewater* exceeding the strength limits set out in Article 2.2.2.1. The ability of a treatment plant to treat higher strength *wastewater* must be confirmed by the manufacturer or vendor with supporting documentation that the treatment plant can handle the higher strength *sewage*.

**B-5.2.2.3. Treatment Capacity**

(1)(b) Article 5.2.1.2. requires consideration of the *sewage* strength and variation in flow during the day or from day to day.

**5.2.2.4. Service Access Not Buried**

(1) Treatment plants require regular inspection and servicing to ensure the expected *effluent* quality is achieved, therefore access openings should not be buried.

### B-5.2.2.6. Base for Packaged Sewage Treatment Plant

(1)

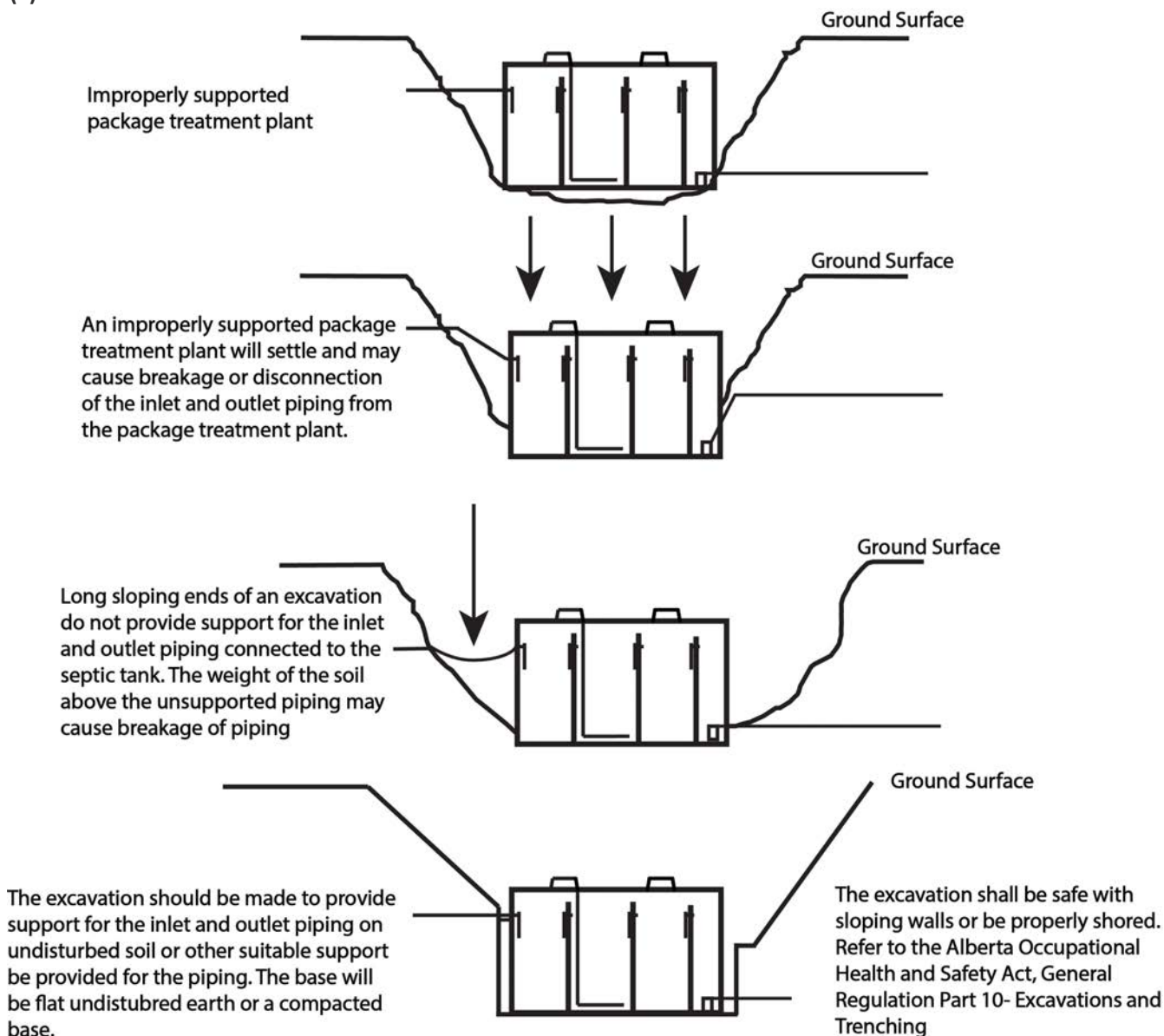

### B-5.2.2.7. Insulation of Tank

(1) The insulation used for this purpose must be suitable for underground use. Insulation suitable for below ground use is required. Rigid Extruded Expanded Polystyrene (XEPS) Foam Board is rated at approx. R5 – R6 per inch of thickness, but this will vary by type and manufacturer. Follow the manufacturer's installation instructions.

**B-5.2.3. Packaged Sewage Treatment Plants – Requirements for Materials**

**B-5.2.3.1. Packaged Sewage Treatment Plant Structural Requirements and Operational Certification**

**(1)(c)(d)(e)** The recognition of the CSA B128.3, “Standard for the Performance of Non-potable Water Reuse Systems”; NSF/ANSI 350, “Onsite Residential and Commercial Water Reuse Treatment Systems”; and NSF/ANSI 350-1, “Onsite Residential and Commercial Greywater Treatment Systems Subsurface Discharge” will accommodate the reuse of *wastewater* as that program develops in Alberta, thus allowing excess *effluent* to be directed to a *soil based treatment system* for final return to the environment using one treatment plant in accordance with this Standard. Reuse may be subject to other guidelines and standards.

**B-5.2.3.1. Packaged Sewage Treatment Plant Structural Requirements and Operational Certification**

**(2)** Tanks that are not *certified* to the referenced standards may be acceptable upon review of structural equivalency, dimensional and physical characteristics required for the treatment process, and a variance issued by the *Administrator of Private Sewage*.

## Section B-5.3. Secondary Treatment – Sand Filters

### B-5.3.1. Sand Filters – Objectives and Design Standards

#### B-5.3.1.5. Application of Effluent

(1) Additional requirements for orifice spacing in the *effluent* distribution system for the sand filter are set out in Article 5.3.2.4.

#### B-5.3.1.6. Alarm Signals

(1) The requirements for a high level alarm within the sand filter is specific to the sand filter and is similar to requirements in Article 2.3.1.2. and other Articles in Section 2.3. or 2.4. that set out requirements for control systems based on the volume of *wastewater* generated by the *development* served. The requirements of those Sections must be met in addition to this specific Article.

### B-5.3.2. Sand Filters – Prescriptive Requirements and Installation Standards

#### B-5.3.2.3. Intermittent Sand Filter

(1) See graphic illustration of the sand filter construction.

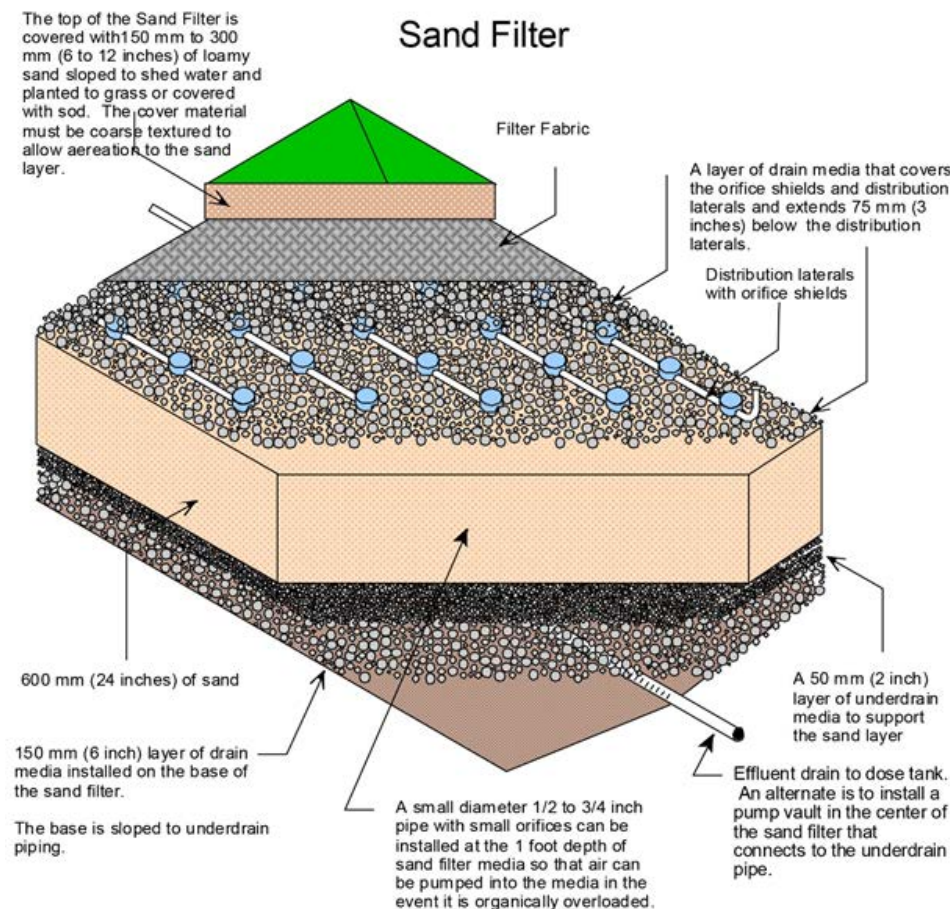

**B-5.3.2.3. Intermittent Sand Filter**

(8) Monitoring ports are needed to enable assessment of the *system* effectiveness during operation. Identifying a problem early may allow action to be taken to correct the potential failure of the system, such as supplying air to the sand layer through the air piping described in Article 5.3.1.9.(3).

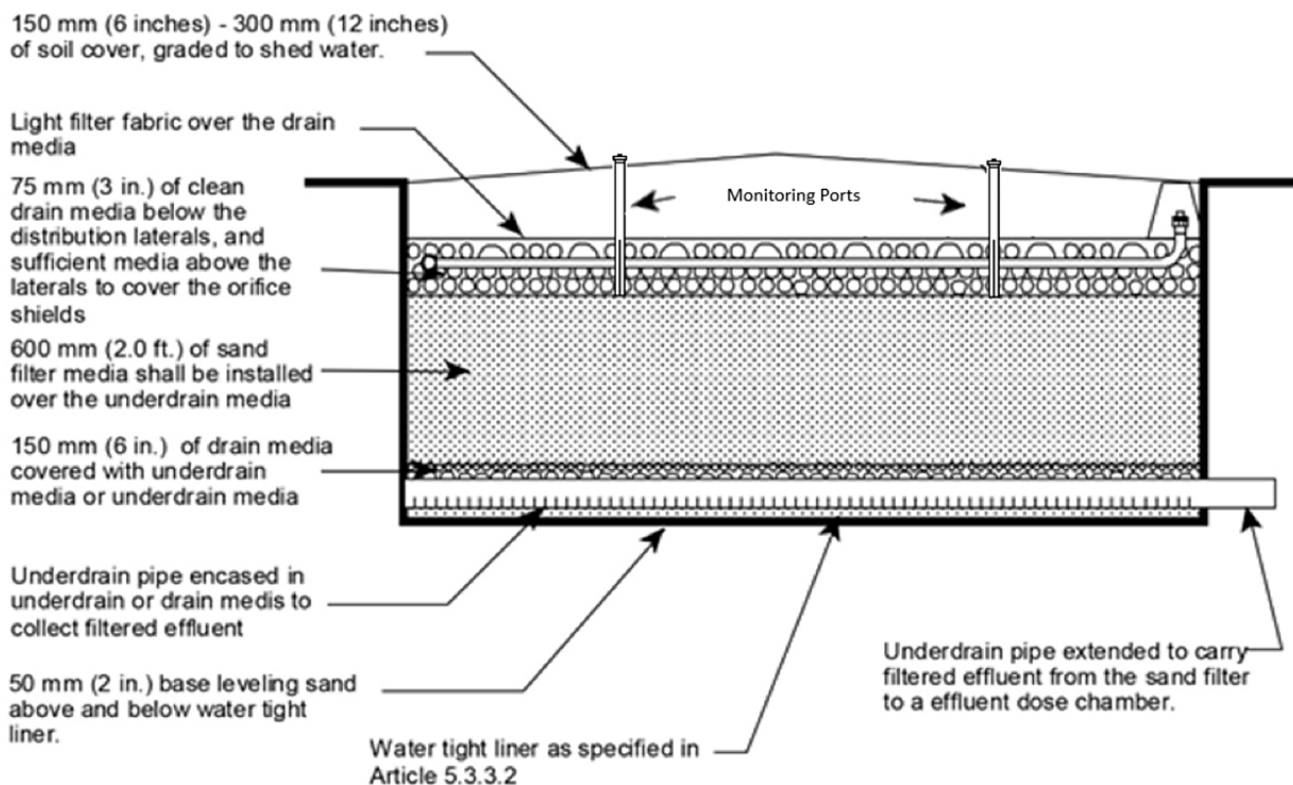

**5.3.2.4. Distribution Laterals**

(1) This article includes specific requirements regarding orifice spacing in addition to the general requirements for pressure *effluent* distribution system requirements set out in Section 2.6.

The top of the sand filter cannot be insulated as that would restrict the required airflow to the sand filter. Only the sides are insulated. The insulation used for this purpose must be suitable for underground use. Insulation suitable for below ground use is required. Rigid Extruded Expanded Polystyrene (XEPS) Foam Board is rated at approx. R5 – R6 per inch of thickness, but this will vary by type and manufacturer.

This website provides additional information on rigid insulation:  
[http://www.espenenergy.com/foam\\_board\\_insulation.htm](http://www.espenenergy.com/foam_board_insulation.htm)

---

## Section B-5.4. Secondary Treatment – Re-circulating Gravel Filters

### **B-5.4.2.** Re-circulating Gravel Filters – Prescriptive Requirements and Installation Standards

#### **B-5.4.2.6.** Above Ground Containment

**(1)(b)** The top of the *gravel* filter cannot be insulated as that would restrict the required aeration to the *gravel* filter. Insulation suitable for below ground use is required. Rigid Extruded Expanded Polystyrene (XEPS) Foam Board is rated at approximately R5 – R6 per inch of thickness but vary by type and brand.

This website provides additional information on rigid insulation:  
[http://www.espenenergy.com/foam\\_board\\_insulation.htm](http://www.espenenergy.com/foam_board_insulation.htm)

## Explanations & Related Articles for Part 6 Initial Treatment Components – Effluent and Pre-treatment Tanks

### Section B-6.2. Settling Tanks (Pre-treatment)

#### **B-6.2.1. Settling Tanks – Objectives and Design Requirements**

##### **B-6.2.1.1. General**

(1) Settling tanks are often installed upstream of the *wastewater* treatment plants to reduce the organic load of the *wastewater* entering the treatment plant. The *settling tank* may often also serve or primarily serve the function of equalizing flow coming from the *development* served. This Standard does not anticipate the quality of *effluent* discharged from the *settling tank* will meet the quality expected from a *septic tank*. The *settling tank* is simply used to reduce *wastewater* strength so it is suitable for a treatment plant or for the equalization of flows or both. A *settling tank* upstream of a treatment plant may be used as a pre-aeration tank to reduce *organic loading* and reducing the aeration loading required of the treatment plant and/or to reduce odour.

##### **B-6.2.1.4. Infiltration/Exfiltration Prevention**

(2) The manufacturer of the tank needs to be consulted and confirm the tank's suitability to the site conditions it is installed in and acceptable anti-floatation methods suitable for the tank are used. In many cases, a stronger tank must be used to withstand the structural forces encountered.

#### **B-6.2.2. Settling Tanks – Prescriptive Requirements and Installation Standards**

##### **B-6.2.2.1. Separation Distances**

(4)(a) Consult the manufacturer of the *settling tank* for suitable odour control equipment and methods.

### Section B-6.3. Lift Stations

#### **B-6.3.1. Lift Stations – Objectives and Design Requirements**

##### **B-6.3.1.1. General**

(1) The *lift station* must be adequately sized with a pump discharge volume and frequency of pump cycle set so as not to overload the next component in the treatment system. In some cases, pumping may have to be adjusted to meet a 24-hour delivery rather than just emptying a tank at a maximum fill level that could wash out a treatment plant or overload a collection system.

##### **B-6.3.1.2. Infiltration/Exfiltration Prevention**

(1) *Lift station* tanks have the same installation requirements as other tanks and are subject to site conditions such as depth of bury, floatation, leakage, sealing against *infiltration*, protection from freezing, and service access requirements.



**B-6.3.1.2. Infiltration/Exfiltration Prevention**

(2) The manufacturer of the tank needs to be consulted and confirm the tank's suitability to the site conditions it is installed in and acceptable anti-floatation methods suitable for the tank are used. In many cases, a stronger tank must be used to withstand the structural forces encountered.

**B-6.3.2. Lift Stations – Prescriptive Requirements and Installation Standards****B-6.3.2.1. Separation Distances**

(1) See graphics in B-4.2.2.7. for more information on excavations of tanks.

## Explanations & Related Articles for Part 7 Site Evaluation

### Section B-7.1. Site Characteristics and Evaluation Procedures

#### **B-7.1.1.** Site Characteristics and Evaluation Procedures – Objectives and Design Standards

##### **B-7.1.1.1. General**

(1) The evaluation of the *soil* characteristics provides the basis of the *system* design. The treatment effectiveness and sustainability of the *system* is dependent on an effective evaluation of the site and soils. The evaluation methods and description of the *soil* must be consistent with the Canadian *System of Soil* classification.

##### **B-7.1.1.2. Site Evaluation**

(1)(a)(i) Slope information and elevation changes are critical information needed to develop an effective design.

##### **B-7.1.1.2. Site Evaluation**

(1)(a)(iii) Vegetation that favors wet *soil* conditions indicate unfavorable conditions for an onsite *sewage system*.

##### **B-7.1.1.2. Site Evaluation**

(1)(b)(ii) Rock outcrops in the area may indicate a limited *soil* depth and a potential breakout point of the *effluent*.

##### **B-7.1.1.2. Site evaluation**

(7) The investigation of the site must consider that all required separation distances can be achieved. This often requires a review of adjacent properties to ensure such things as water wells on the adjacent properties are not too close to the onsite *system*.

##### **B-7.1.1.3. Site Evaluation for Complex On-site Sewage Systems**

(1) In order to meet the requirements of this Article, the expertise of a Professional will be needed to carry out the assessment. The majority of the expertise needed is within the scope of a Professional Hydrogeologist. In addition, Article 7.1.1.3. sets out minimum investigation requirements of the underlying *soil* and hydrogeological conditions below the site of the *effluent infiltration* area.

##### **B-7.1.1.3. Site Evaluation for Complex On-site Sewage Systems**

(2)(b) Lithology in the context of this Article means the *soil*, and sub-*soil* classification.

##### **B-7.1.1.3. Site Evaluation for Complex On-site Sewage Systems**

(3) In order to meet the requirements of this Article, a monitoring well developed to a minimum depth of 15.23 m (50 ft.) will be necessary in order to determine many of the characteristics to be assessed (such as ground water flow direction, horizontal and vertical conductivity of the *soil* below, the lithology of the *soil* throughout the borehole drilled for installation of the well, and baseline groundwater quality). While a

Professional Hydrogeologist will be needed for this assessment, the designer/installer and SCO need to have a basic understanding of what is required and the extent of work needed.

#### **B-7.1.1.3. Site Evaluation for Complex On-site Sewage Systems**

(7) The document referenced discusses the constituents of concern in the *wastewater* and the models appropriate for assessing transport and attenuation. It is valuable in deciding which model is appropriate in differing conditions and the concern to be addressed. While the document is largely watershed scale focused, the discussion on appropriate models is applicable on the smaller site-specific or subdivision-specific scale.

#### **B-7.1.1.4. Site Evaluation Report**

(1) A key piece of the report is a plan of the property that includes the dimensions and shape of the property. The plan must show dimensions or a scaled drawing the pertinent parts of the design and features that require separation distances noted in the Standard to be maintained.

Large systems over 5.7 m<sup>3</sup> (1,250 Imp. gal.) require additional investigation of the *soil* to predict potential *groundwater mounding*. See Article 8.1.1.9.(b) on *groundwater mounding*. Flow volumes exceeding 5.7 m<sup>3</sup> (1,250 Imp. gal.) require the involvement of a professional (e.g. an engineer).

#### **B-7.1.1.4. Site Evaluation Report**

(1)(h) Requires the number of test pits and locations be justified to show the characteristics have been adequately determined.

#### **B-7.1.1.4. Site Evaluation Report**

(1)(i) This Clause requires the investigation include the determination of characteristics for the *development* that will affect the volume and strength of the *wastewater* generated. See Section 2.2. for additional requirements on determining flow volume and strength.

### **B-7.1.2. Site Characteristics and Evaluation Procedures – Prescriptive Requirements and Installation Standards**

#### **B-7.1.2.2. Depth of Soil Investigation**

(1) The excavation reveals the characteristics that affect design choices and limits. The depth of the evaluation needs to be sufficient to show the required *vertical separation* exists for the type of *system* that will be selected based on the *soil*-profile characteristics. The investigation of the –soil-profile should be sufficient to determine the *linear loading* capacity of the *soil*. When a restrictive layer is encountered, the excavation does not need to go deeper. The type of *system* to be installed is selected only after a profile is investigated to the related depth.

#### **B-7.1.2.3. Percolation Test**

(1) A percolation test is not acceptable for the design of a *system*. A designer may choose to do this test to gain further information but the results of the percolation test cannot be used for design.

## Explanations & Related Articles for Part 8 General Soil-based Treatment

### Section B-8.1. Soil-based Treatment

#### **B-8.1.1.** Soil-based Treatment – Objectives and Design Standards

##### **B-8.1.1.1. General**

(1) The objectives, design requirements and prescriptive requirements set out in this Section apply to all *soil*-based treatment *system*. Continuous reference back to this Section is required for a *soil*-based treatment *system* design and installation.

##### **B-8.1.1.2. Infiltration Area**

(1) This Article lists 6 key items that are identified in the site evaluation. These characteristics must be applied to the selection of the suitable type of final *soil* based *effluent* treatment and dispersal *system*. The *size* of the *system* is a factor of these characteristics that indicate the capacity of the *soil* to receive the *effluent* and the capability of the *soil* to treat the *effluent*, and the volume of *wastewater* generated by the *development* being served.

##### **B-8.1.1.3. Effluent Loading Rates On Soil and Restriction on Coarse Sand**

(1) *Effluent* loading rates set out in Table 8.1.1.10. are related to the characteristics of the *soil* and the *wastewater* strength.

##### **B-8.1.1.3. Effluent Loading Rates On Soil and Restriction on Coarse Sand**

(2) Coarse sand textured *soil* has a very limited treatment capability, as the *field capacity* of the *soil* is low.

##### **B-8.1.1.4. Vertical Separation**

(1) The *effluent* must be able to travel away from the *infiltration* area. To do this, at least 300 mm (1 ft.) of in situ *soil* is needed. Although *linear loading* rates would be low, with this shallow depth to a restrictive layer an effective system may be designed. The available *vertical separation* is the depth of suitable *soil infiltration surface* downward to the restrictive layer. This *vertical separation* is the aerobic treatment zone available in the *soil* to treat the *sewage*. This minimum depth is the zone needed to achieve treatment. The depth of *soil* from the top of the ground surface, in which *soil* water has a pressure head less than atmospheric pressure and is retained by a combination of adhesion and capillary action, to the depth at which *soil* water at atmospheric pressure (*vadose zone*). The sentences above prevent excavating through shallow restrictive layers to install a treatment system below a restrictive layer.

##### **B-8.1.1.6. Effluent Soil Infiltration Surface Area Design**

(1) *Primary treated effluent* is the quality expected from a *septic tank* when the raw *wastewater* from the *development* does not exceed *typical wastewater* strength.

##### **B-8.1.1.6. Effluent Soil Infiltration Surface Area Design**

(2) *Effluent* applied to the *soil* will move downward through the *soil*. *Effluent* will often have to move horizontally through the *soil* because the downward movement is obstructed by more compact, fine textured, unstructured *soil* encountered at deeper depths. The amount of *effluent* that can move horizontally is limited

by the *soil* conditions. The amount of *effluent* that must move horizontally is the *linear loading rate*. The shape (geometry) of the total *soil infiltration surface* affects the amount of *effluent* needing to go horizontally per meter or foot of the system length. An *infiltration* area that is long and narrow, with the longest dimension a right angle to the slope of the ground, will reduce the amount of *effluent* at any given point along the system that must move horizontally in the *soil* below.

**B-8.1.1.7. System Geometry and Linear Loading Rate Design**

(1) The design of the *treatment field* must ensure the *effluent* that is applied day after day can move away from the *treatment field* horizontally through the available *soil*. The *effluent* will need to move hundreds of feet away from the *treatment field* as over time more and more *effluent* is applied. To achieve this, the design must consider the capacity of the *soil* to move the *effluent* horizontally. See graphic below of *linear loading* concept for treatment fields.

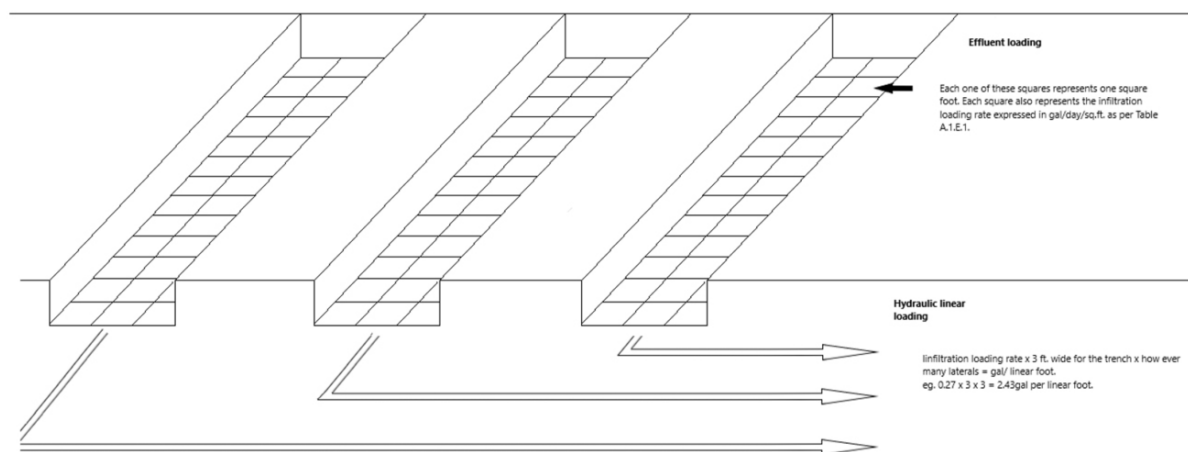

**B-8.1.1.9. Groundwater Mounding Considerations Required**

(1) Article 8.1.2.3. requires the *effluent linear loading* of the system design to not exceed the values set out in Table 8.1.1.10. Using these limits will address concerns about *groundwater mounding* below the *infiltration* system in smaller systems. As per Article 8.1.1.7., *linear loading* rates need to be considered for all *soil*-based systems. If *infiltration* distance exceeds 1200 mm (4 ft.), *linear loading* rates must still be considered. However, for large systems the potential for *groundwater mounding* at the site must be carried out for systems where the peak daily volume of *wastewater* anticipated from the *development* served exceeds 5.7 cubic meters (1,250 Imp. Gal.) per day.

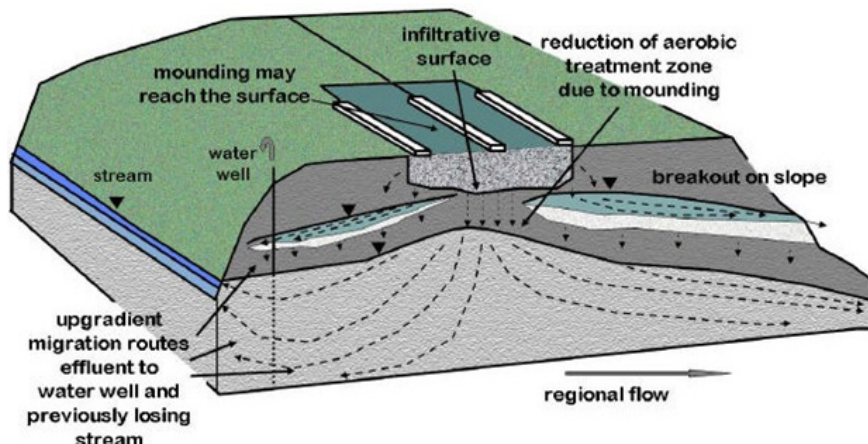

Source: Poeter E., J. McCray, G. Thyne, and R. Siegrist. 2005. *Guidance for Evaluation of Potential groundwater mounding Associated with Cluster and High-Density Wastewater Soil Absorption Systems*. Project No. WU-HT-02-45. Prepared for the National Decentralized Water Resources Capacity development Project, Washington University, St. Louis, MO, by the International Groundwater Modeling Center, Colorado School of Mines, Golden, CO. Page: Title page.

**B-8.1.1.10. Effluent Loading Rates on Soil Infiltration Surface**

(2) The columnar *structure* is a telling feature that this is a solonetzic *soil*. A solonetzic *soil* is a *soil* that will swell when wetted. This is due to the high clay content in the *soil* at the top of the columnar *structure* and because it has a high sodium level. When it swells from wetting all the macro pores of the *soil structure* will close and no water will move down through the *soil* profile.



**B-8.1.1.10. Effluent Loading Rates on Soil Infiltration Surface**

(4) Prismatic *structure soil* courtesy of Chad Widmer



**B-8.1.1.11. Supplementary Air Supply to Soil-based Effluent Treatment Systems**

(1) This Article clarifies requirements that must be met when providing an auxiliary air supply to the *soil*-based treatment component. The Clauses set out the conditions that have to be met when supplying additional air. A method of introducing air into the *soil infiltration* area or sand layer of a *treatment mound* or sand filter in their initial system designs. The introduction of additional air has been used as a method of helping a system to recover from unexpected overloading. However, the provision of air was intended as an intermittent supplement to assist the recovery of a system that had been subjected to an unplanned temporary overload. It was not used as a way to increase *effluent* loading.

**B-8.1.2. Soil-based Treatment – Prescriptive Requirements and Installation Standards****B- 8.1.2.1. Evaluation**

(1) Part 7 of this Standard set out the characteristics of the site that need to be identified to select the appropriate soil-based *infiltration* system for the site based on available *vertical separation* and the characteristics needed to select *effluent* loading rates on the *soil infiltration surface* and determine the *linear loading* capacity of the *soil*.

**B-8.1.2.2. Infiltration Loading Rate**

(2) Sentence (2) sets out maximum *effluent* loading rates on the *infiltration* surface that cannot be exceeded. These limits are set to ensure the 7-day travel time of the *effluent* through the required *vertical separation* is achieved.

**B-8.1.2.3. Linear Loading Rates Not Exceeded**

(1) Treatment mounds are most often used to address sites where there is a shallow restrictive layer that limits the depth of suitable soils for treatment and the downward movement of *effluent*. Because the restrictive layer limits the downward movement of the *effluent*, the added *effluent* must move horizontally in the *soil* away from the *treatment mound*. The design of the *mound* must ensure the *effluent* that is applied day after day can move away from the *mound* horizontally through the *soil* above the restrictive layer. The *effluent* will need to move hundreds of feet away from the *mound* as over time more and more *effluent* is applied. To achieve this, the design must consider the capacity of the *soil* to move the *effluent* horizontally. The graphic below shows the concept of *linear loading*.

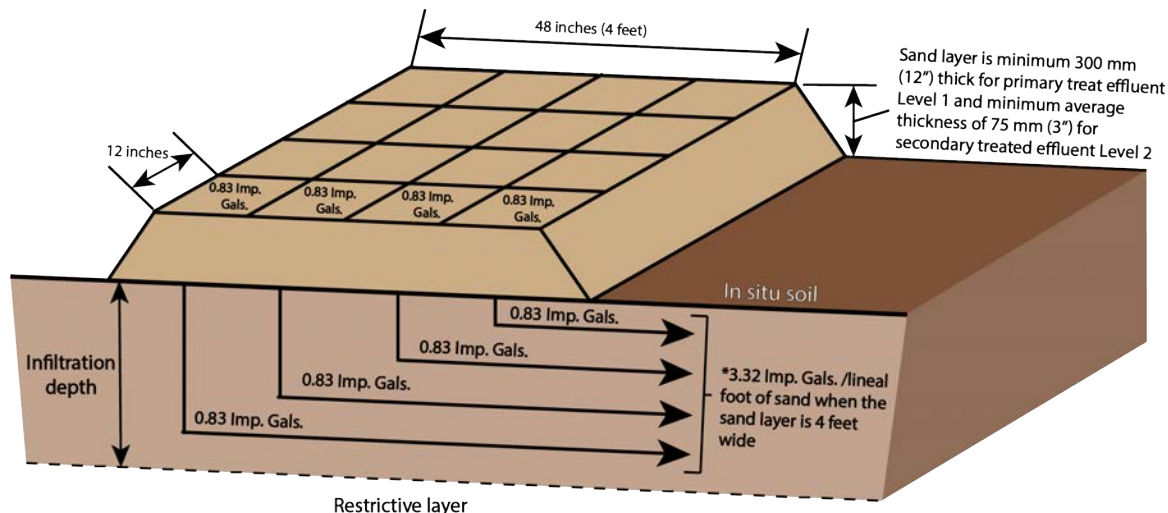

\*The maximum effluent hydraulic loading rate is 0.83 Imp. Gal./ sq. ft./ day unless limited by Article 8.1.2.2.

\*Each square on the diagram represents a square foot of sand (12" x 12").

**B-8.1.2.4. Infiltration Loading Rate Reduced, Coarse Fragments**

(1) Table 8.1.1.10 sets out the volume of *effluent* that can move through a *soil* profile based on the characteristics of the *soil*. Exceeding these limits may create an excessive groundwater *mound* under the system that reduces the required *vertical separation* or in worse cases causes the *effluent* to surface on the ground.



## Section B-8.2. Treatment Fields

### B-8.2.1. Treatment Fields – Objectives and Design Standards

#### B-8.2.1.3. Effluent Loading Rates

(1) *Primary treated effluent* level 1 is the quality expected from a *septic tank* when the raw *wastewater* from the *development* does not exceed *typical wastewater* strength, provided the required retention time is achieved. *secondary treated effluent* is the quality expected from a packaged *sewage* treatment plant, sand filter, or re-circulating *gravel* filter and meets the quality parameters set out in Table 5.1.1.1. for Levels 2, 3, or 4.

#### B-8.2.1.6. Trench Width and Separation

(1) Trenches must have a minimum of 900 mm (3 ft.) of undisturbed earth between trenches as set out in Article 8.2.2.3. Sentence (2). Trenches for weeping lateral must be 0.3 m (12 in.) minimum width and 0.9 m (36 in.) maximum width. The maximum depth of the trench is 0.9 m (36 in.) See Article 8.2.2.3. Sentence (1). There is no minimum depth but a *soil cover* of 300 mm (12 in.) has shown, over time, to be adequate protection from frost for the *weeping lateral trench*. The required depth to prevent freezing may be less depending on the type of *soil* and protection from surrounding trees and winter snow cover, which will vary from site to site. The gravity weeping lateral perforated piping is installed with the tip of the pipe even with the top of the *gravel* in the trench. See graphic below for cross section detail on *weeping lateral trench*, and graphic for re-aeration path of weeping lateral trenches.

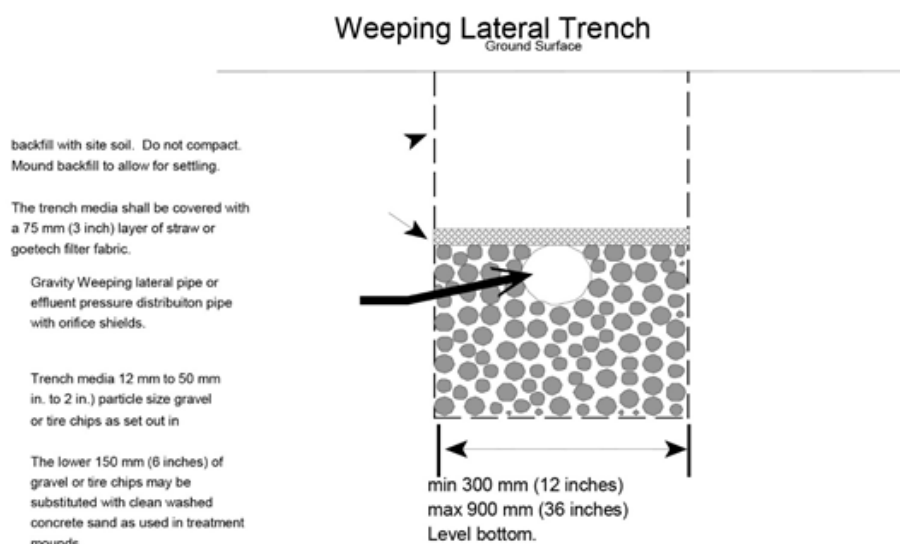

#### Trench Media Volumes Required

Depth of Trench Media	Trench Width	Cubic Meters (Yards) of Media Meter (Foot) Weeping
150 mm (6 inches)	600 mm (24 inches)	0.9 <sup>3</sup> (0.038)
300 mm (12 inches)	600 mm (24 inches)	0.18m <sup>3</sup> (0.075)
150 mm (6 inches)	900 mm (36 inches)	0.14m <sup>3</sup>
300 mm (12 inches)	900 mm (36 inches)	0.27m <sup>3</sup> (0.11)

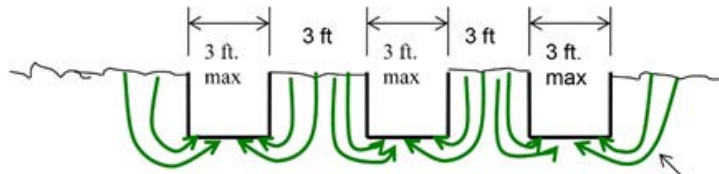

Aeration pathway to trench bottom to meet oxygen demand from effluent application. A sufficient width between trenches is required to allow the required supply of oxygen to the underlying soil. As the depth to the infiltration surface increases the transmission of oxygen through the soil to that depth decreases. A wider separation of trenches should be applied as the depth increases.

**B-8.2.1.11 Monitoring Effluent Ponding Depth**

(1) See graphic below for illustration of these ports.

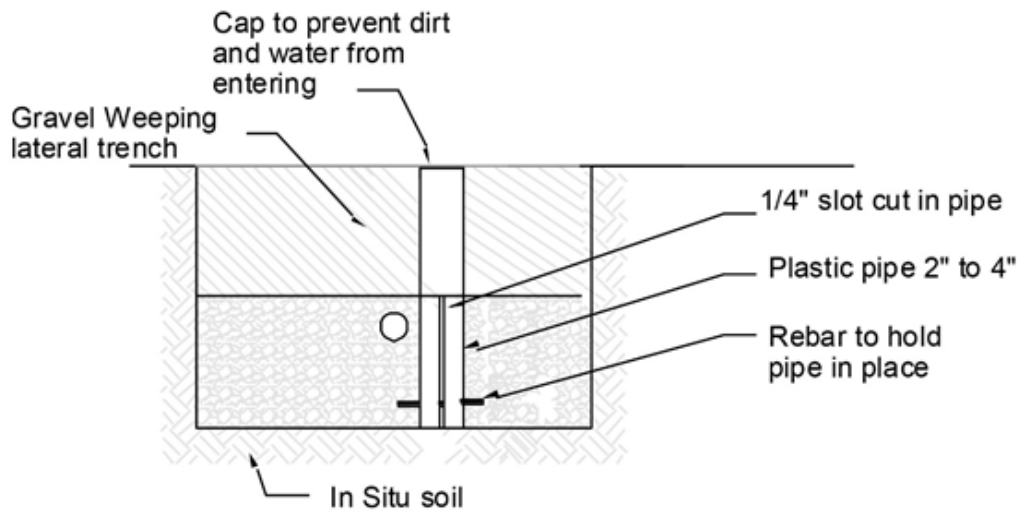

**Monitoring Pipe for Effluent Ponding in Chambers**

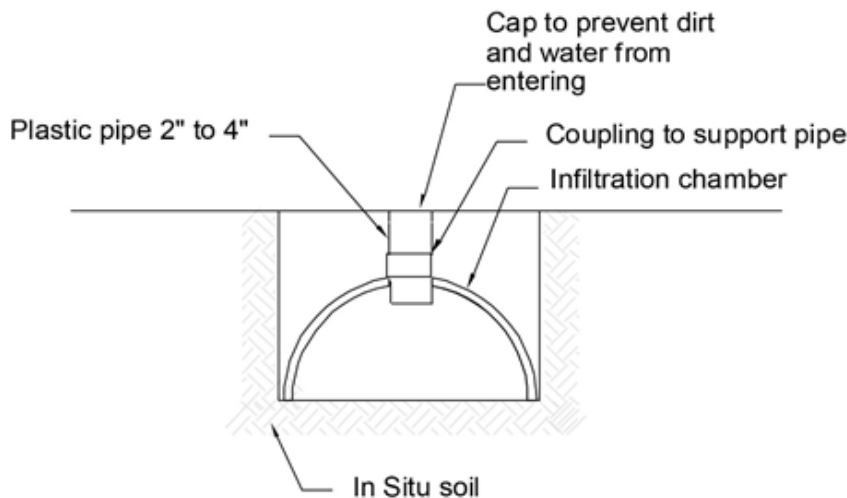

### B-8.2.2. Treatment Fields – Prescriptive Requirements and Installation Standards

#### B-8.2.2.5. Gravity Distribution of Effluent to Treatment Field

(1) See graphic for how to construct equal distribution using a header system.

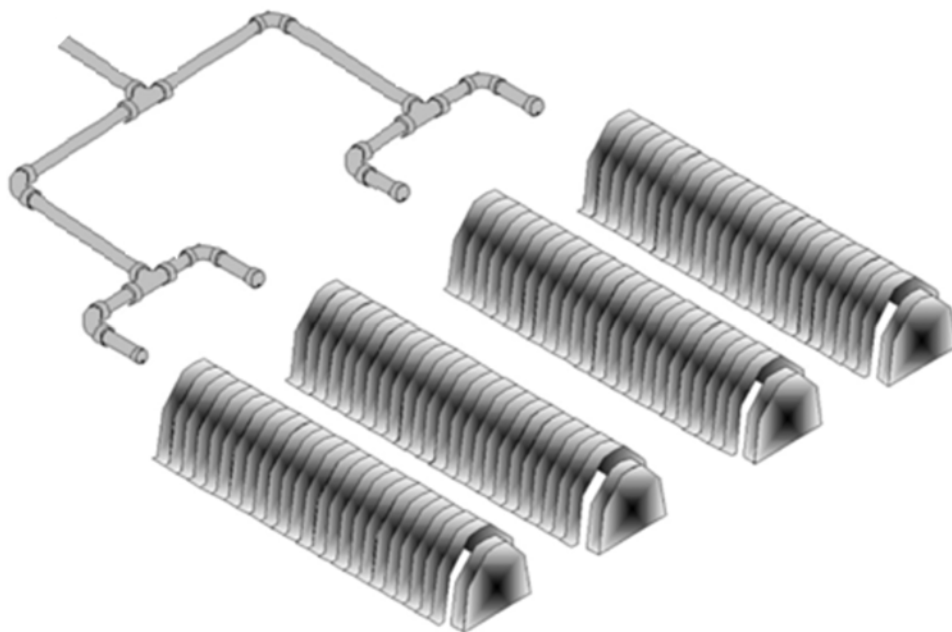

#### B-8.2.2.6. Gravity Weeping Laterals at Different Elevations

(1) See graphic on how to install a gravity fed *treatment field* on different elevations.

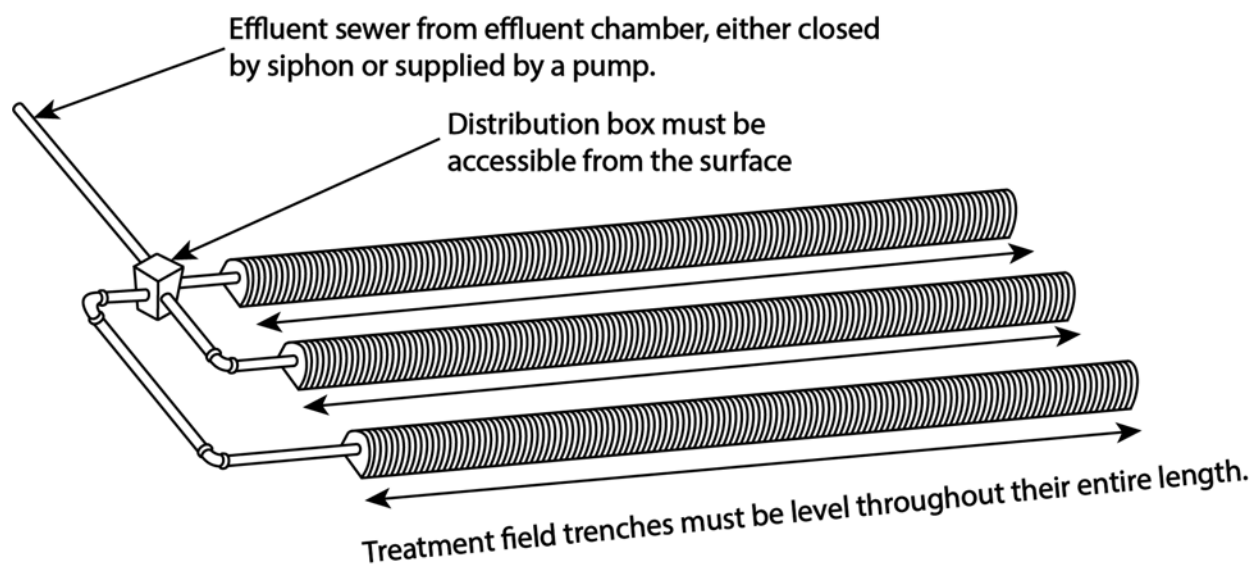

**B-8.2.2.7. Distribution Box**

(1) An elbow to direct the flow downward into the distribution box needs to be installed to prevent preferential flow. To minimize the potential for unequal flow from the distribution box, it is important to:

- keep the distribution box as small as possible (see Article 8.2.2.7.) ,
- keep the number of outlets to a minimum,
- keep the outlets as close together as possible,
- provide a volume dose to the distribution box and field, and
- prevent the momentum of the incoming *effluent* from washing directly into an outlet creating preferential flow.

### Distribution Box

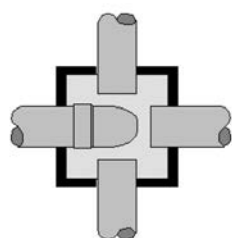

Plan View

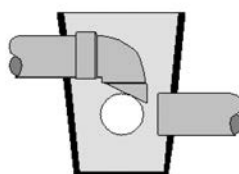

Elevation Section View

**B-8.2.2.12. Raised Treatment Field Fill Material**

(1) Fill material imported that is between and over the weeping lateral trenches must be coarse textured soils as specified in this Article to allow air to infiltrate into the trench.

**B-8.2.2.12. Raised Treatment Field Fill Material**

(2) A capping *soil* enables sufficient water holding capacity to support grass growth over the raised *treatment field*, which will help reduce the *infiltration* of precipitation (rain and snow melt) into the field area.

**B-8.2.3.**

**Treatment Fields – Requirements for Materials**
**B-8.2.3.1. Weeping Lateral Trench Media**

(1)(a) *Fines* in the *gravel* will be washed off by the applied *effluent* and will have the tendency to fill any *soil structure* macro pores and so limit the *infiltration* capability of the *soil*.

## Section B-8.3. Chamber System Treatment Fields

### B-8.3.1. Chamber System Treatment Fields – Objectives and Design Standards

#### B-8.3.1.2. Serial Distribution Prohibited

(1) *Serial distribution of effluent* is where the *effluent* travels through 1 *weeping lateral trench* before entering another *weeping lateral trench*. This method is prohibited.

#### B-8.3.1.4. Calculation of Infiltration Area

(1) Actual chamber dimensions are required to be able to calculate the exterior width dimension of the chamber. The dimensions should be available from the chamber Manufacturer.

### B-8.3.2. Chamber System Treatment Fields – Prescriptive Requirements and Installation Standards

#### B-8.3.2.3. Prevention of Soil Disturbance and Erosion

(1) The intent is the *infiltration* surface is protected from erosion at the entry point. A 2-inch layer of *gravel* can be laid over the first 1.5m (5 ft.) of the trench bottom; a *geotextile fabric* can be laid over the *infiltration* surface for the first 1.5m (5 ft.); or some other suitable means that protects the *infiltration* surface from the erosion of the entering *effluent*. *geotextile fabric* must not be placed over the entire *infiltration* surface. The method used to supply the *effluent* to the chamber needs to be considered when selecting the most appropriate method of protecting the *infiltration* surface from erosion. Some methods will result in higher flow rates than others. The purpose is to stop the incoming flow from picking up fine *soil* particles and washing them further down the *infiltration* surface that could plug the *soil* pores.

Recommended *geotextile fabric* specifications are as follows:

- Fabric shall be non-woven
- Weight: 0.35 oz./s.y. to 1 oz./s.y.
- Apparent Opening Size (AOS): 20-30 U.S. Sieve (ASTM D 4571)

## Section B-8.4. Treatment Mounds

### B-8.4.1. Treatment Mounds – Objectives and Design Standards

#### B-8.4.1.1. General

(2) The purpose of the *treatment mound* is to treat the *sewage effluent*, preventing a negative impact of the near surface and deeper groundwater as to effectively disperse the *effluent* in the *soil* so there is no risk of direct contact with *effluent*.

#### B-8.4.1.3. Sand Layer - Orientation of Slopes

(1) The slope of the land at site may not be simple and all in one direction. Often the slope is curved and the sand layer of the *mound* must be curved to remain level along its length on such a curved slope. When located on a concave or convex slope with a concave contour, the *linear loading* in the downslope direction may become concentrated and overload the capacity of the *soil*. The graphics below depicts that concept.

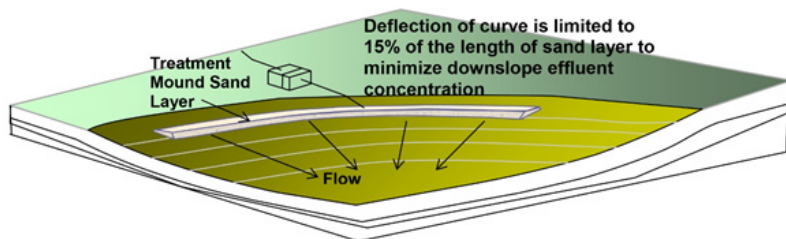

To avoid problems with surfacing *effluent* cause by a concentration of *effluent* downslope of the sand layer, Article 8.4.1.3. (1) (c) requires the amount of curvature deflection be limited to 15%. This measurement of a maximum 15% deflection is shown in the plan view.

**Convex slope  
Concave contour**

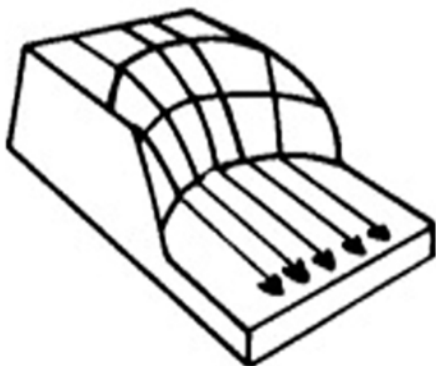

**Concave slope  
Concave contour**

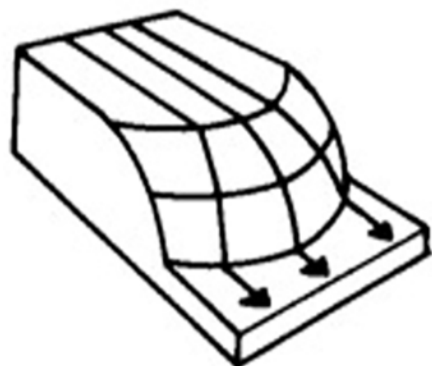

**Convex slope  
Convex contour**

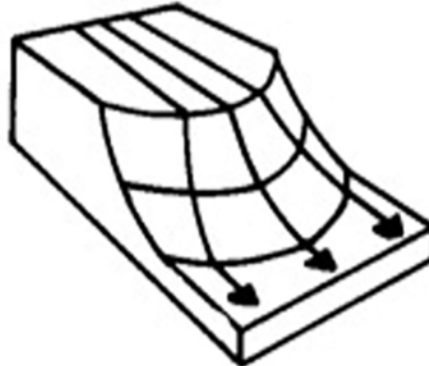

**Concave slope  
Convex contour**

**B-8.4.1.5. Sand Layer – Secondary Treated Effluent**

(1) The depth of the sand layer required when applying secondary treated *effluent* is less than when applying primary treated *effluent*, as the sand layer is not being relied upon to achieve the treatment of the primary treated *effluent* to a secondary standard. The purpose of the sand layer when applying secondary treated *effluent* is to ensure effective contact with the underlying in situ *soil* and to provide some capacity in the coarse textured sand to receive and store the *effluent* applied, until it infiltrates horizontally into the fill material and vertically into the in situ *soil* below.

### B-8.4.1.7. Infiltration Into In Situ Soil

(1)(b) The following graphic of a *treatment mound* on a level site shows the *effluent infiltration* area into the in situ *soil* is considered to be on both sides of the sand layer of the *mound*. The area covered by the *berm* must be at least equal to the area required to infiltrate the applied *effluent* based on secondary treated *effluent*. To assist in understanding the differences in the area of the sand layer and in situ *soil infiltration* area along with the detail of the construction of the *treatment mound* the following graphics are provided. A comparison of the level site graphic and the graphic of a sloped site shows the difference in where the in situ *soil effluent infiltration* area covered by the *berm* is considered. On a sloped site of more than a 1%, the area covered by the *berm* upslope of the sand layer is not considered as in situ *soil infiltration* area.

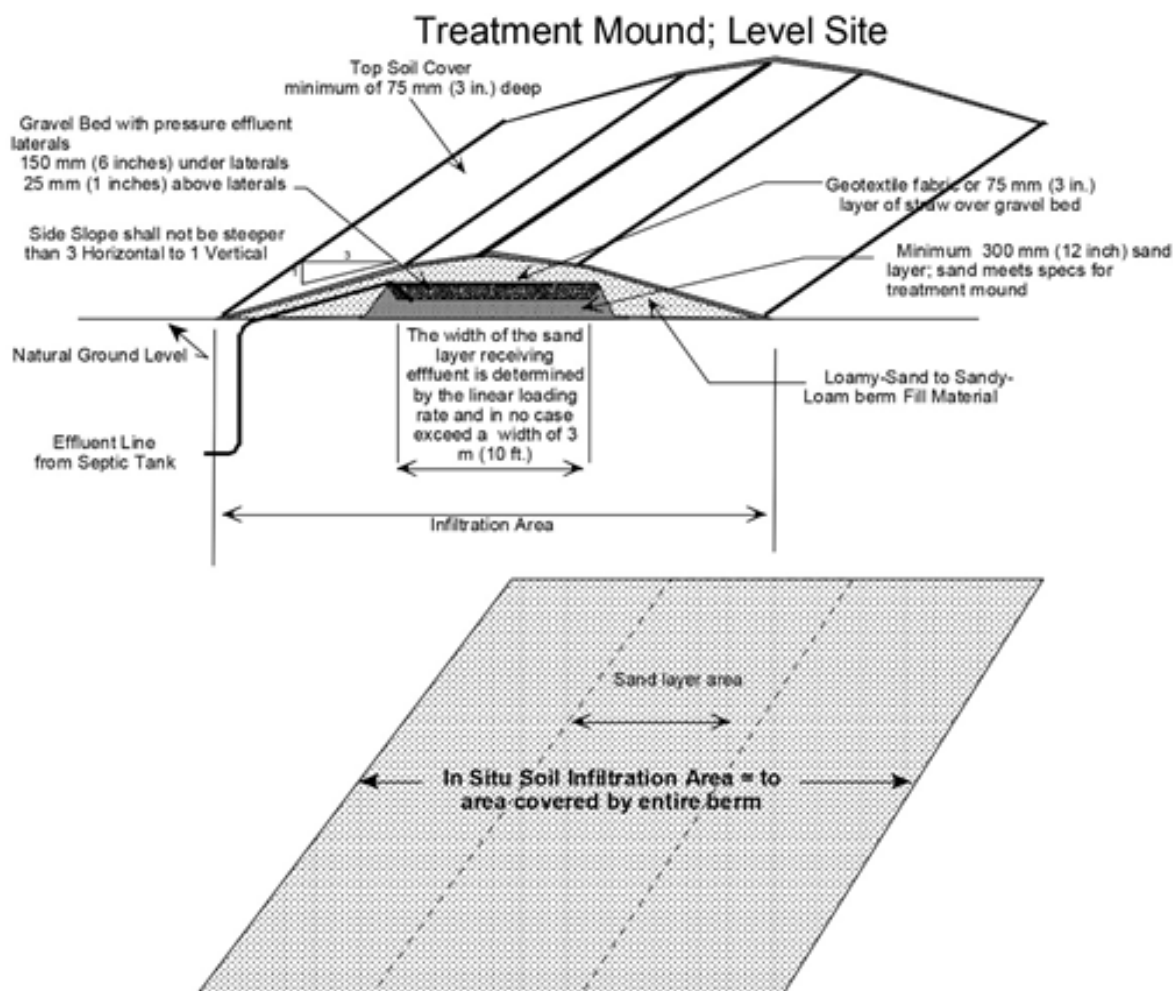

When the *mound* is on sloping ground, the *effluent* will move downslope of the sand layer. As such, it is only the area of in situ *soil* under the sand layer and covered by the downslope *berm* that counts as effective *infiltration* area. The graphic below shows the area considered as effective in situ *soil effluent infiltration* area applied in the design of a *treatment mound*. The area measured from the upslope side of the sand layer to the downslope side of the *berm* is considered the area available for *infiltration* based on the loading rate allowed for secondary treated *effluent*. Often the distance of the *berm* must extend on the slope to maintain a 1 vertical to 3 horizontal slope will exceed the required *infiltration* area based on the *effluent* loading rate, however, that must always be checked in the design.

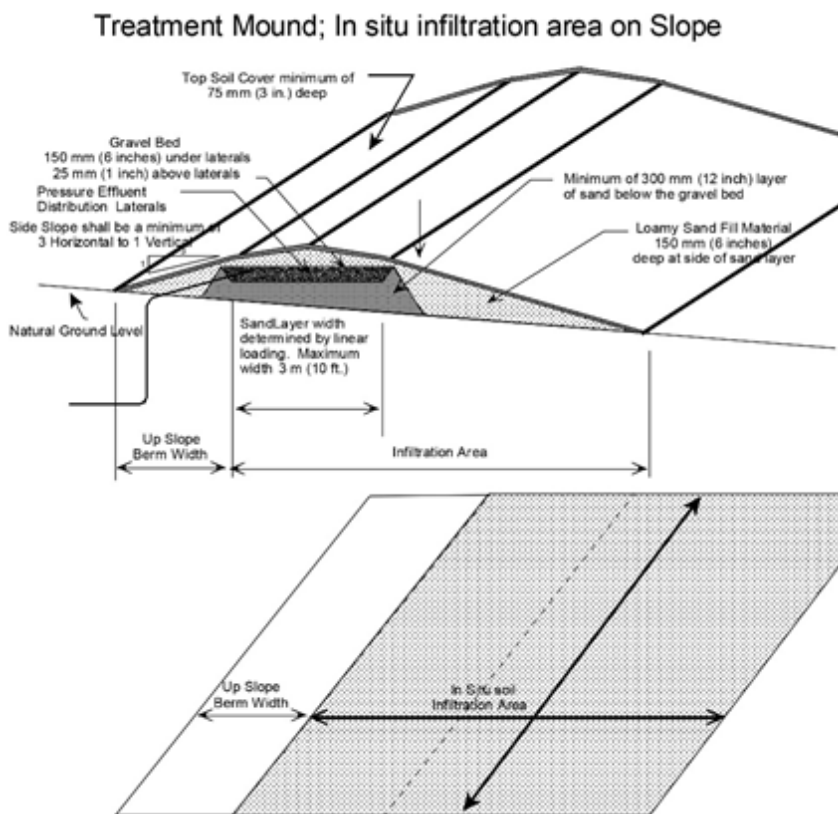

**B-8.4.1.10. Maximum Dose Volume**

(1) Maximizing the number of doses applied to the sand layer is needed to ensure effective treatment. The sand used in the sand layer has very limited water-holding capacity. Large doses will quickly flow through the sand layer, creating saturated condition and reduce treatment effectiveness. Eventually that overloading will cause a thicker biomat to form on the sand layer or the sand layer *soil* interface reducing *infiltration* capacity.

**B-8.4.1.12. Effluent Ponding Monitoring Pipes**

(2) Monitoring intervals of these conditions using the monitoring pipe needs to be set out in the operation and maintenance manual required by Article 2.1.2.8. See graphic below for monitoring ports.

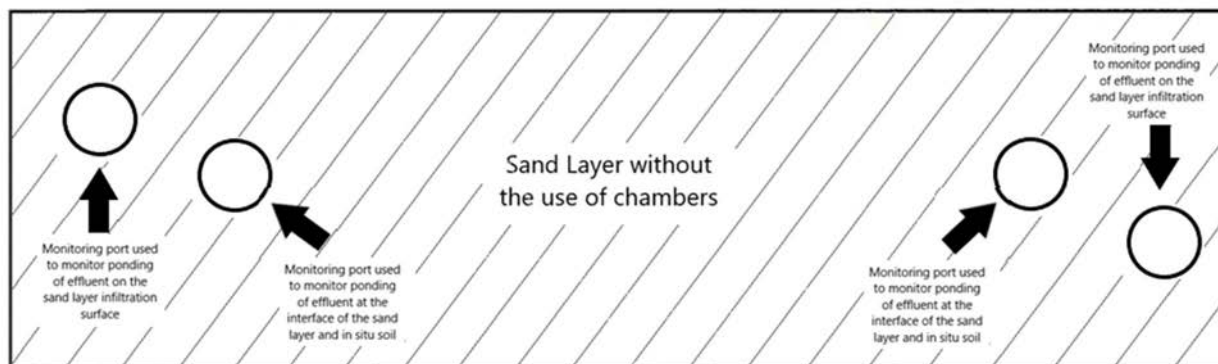



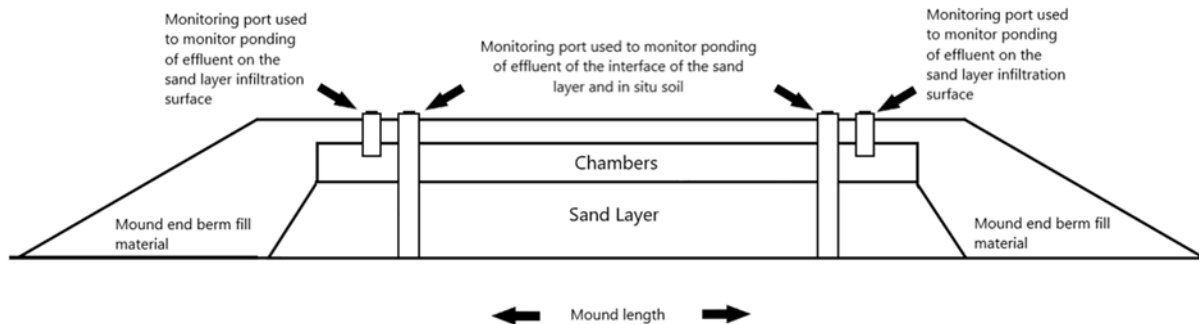

## B-8.4.2. Treatment Mounds – Prescriptive Requirements and Installation Standards

### B-8.4.2.4. Placement of Sand Layer

(2) Leaving the sod unbroken will result in a thick biomat at the in situ *soil* interface as microorganisms try to break down the organic matter of the grass and roots. A biomat that is continuous across the *mound* will develop.

## Section B-8.5. Sub-surface Drip Dispersal and Irrigation

### B-8.5.1. Sub-surface Drip Dispersal and Irrigation – Objectives and Design Standards

#### B-8.5.1.1. General

(1) Drip dispersal systems have been used in agricultural irrigation for many years. They also provide an effective means of dispersing *wastewater effluent* into the final *soil based treatment system*. The drip dispersal can be used with the purpose focused on the dispersal of the *effluent* into the *soil* and treatment or it can be designed to provide irrigation of green spaces.

#### B-8.5.1.2. Effluent Treatment Quality in Soil

(1) The purpose of the drip dispersal system is to treat the *sewage*; preventing a negative impact on the near surface and deeper groundwater, and to effectively disperse the *effluent* in the *soil*, so there is no risk of direct contact with *effluent*.

#### B-8.5.1.3. Required Effluent Quality and SAR Limits

(1) See Table 5.1.1.1. for specifics on the *effluent* quality referenced in Article 8.5.1.3. As the drip dispersal piping is placed shallower in the *soil* there is more tendency for the applied *effluent* to be drawn up toward the *soil* surface as plants use the moisture or to be pushed to the *soil* surface due to limited *infiltration* capacity. When the drip dispersal piping is placed shallow in the *soil*, it requires a higher initial treatment level with regard to disinfection as set out in Clause 8.5.1.3.(1)(b)

#### B-8.5.1.3. Required Effluent Quality and SAR Limits

(2) The application of an *effluent* having a high Sodium Adsorption Ratio (SAR) will result in sodium salts accumulating in the *soil* as the vegetation uses and removes the water from the *soil*. The accumulating sodium salts will eventually limit the ability of the plant growth to take up moisture and nutrients, eventually

being so limiting that the vegetation will die off. When used for irrigation purposes, consideration should be given to the water demands for irrigation and providing effective coverage of the area to ensure even watering of the vegetation, so strips do not show up in the grassed area in particular. The quality of water chemistry must also be considered. If the *effluent* has excess amounts of sodium in it the sodium will build up in *soil* as the plants take up water and eventually increase to levels that will damage the vegetation. Article 8.5.1.3 sets out qualities of *effluent* concerning both the SAR of the *effluent* and the requirement for disinfection when the *effluent* is used for irrigation and the drip dispersal piping is installed less than 300mm (12 in.) below surface. The *effluent* quality must be equal to or better than 15 mg/L TSS and CBOD5 and to 200 CFU/100mg fecal coliform.

#### **8.5.1.5. Winter Use Restrictions and Design**

(1) Drip dispersal systems are not well established in cold climates such as in Alberta. Because of this, a drip dispersal system must be backed up with another type of system set out in the standard that is known to typically survive the winter season without freezing. This may be a *holding tank* if the system owner agrees and the municipality has no restrictions on the use of a *holding tank*. Although not extensively proven in Alberta's cold climate there are installations that have been shown to survive the winter if the piping is not buried extremely shallow for irrigation purposes.

#### **B-8.5.1.7. Drip Dispersal Tubing Layout and Dosing Design**

(1) Pressure compensating orifices provide for a more equal distribution of the *effluent*.

#### **B-8.5.1.7. Drip Dispersal Tubing Layout and Dosing Design**

(2) Drip dispersal systems used for *sewage* systems include both root intrusion and bacterial growth inhibitors. These inhibitors may be impregnated into the piping or injected into the *effluent* prior to the dispersal process.

#### **B-8.5.1.7. Drip Dispersal Tubing Layout and Dosing Design**

(4) Achieving this objective set in Clause (4) is accomplished by either closer spacing of the laterals or closer spacing of the orifices in the piping.

### **B-8.5.2. Sub-surface Drip Dispersal and Irrigation – Prescriptive Requirements and Installation Standards**

#### **B-8.5.2.1. Separation Distances**

(1) This Article allows the drip dispersal piping to be located close to a *building* when used specifically for irrigation, and when the *effluent* loading rates are limited to irrigation needs of the vegetation. Where this is applied, the sections of the drip dispersal piping close to the *building* should be shut off or limited when irrigation is not required, or irrigation needs are limited.

#### **B-8.5.2.4. Clean-outs and Piping Access**

(1) Piping clean-outs are needed to check the system and ensure continued effective operation. Use of these clean-outs and frequency of checks need to be set out in the operation and maintenance manual required by Article 2.1.2.8.

### B-8.5.2.5. Manufacturer's Recommended Practices

(1) Manufacturers of drip dispersal piping and systems develop extensive installation and design documents. These instructions must be followed as required by this Article, except where the instruction conflicts with this Standard. Setting up the design and control systems to make effective use of the system and minimize the potential for freezing is complex. The companies supplying the drip dispersal systems have design tools and the system components needed to make a successful system. Any design of a drip dispersal system must make use of the manufacturer's installation guides as set out in Article 8.5.2.5. If there is a conflict between the manufacturer's instructions and this Standard, the requirements of this Standard must be applied.

### B-8.5.3. Sub-surface Drip Dispersal and Irrigation – Requirements for Material

#### B-8.5.3.1. Piping

(1) Most of the drip dispersal piping supplied by the major manufacturers complies with this Article. However, when selecting available piping, the designer and installer need to ensure that the piping and orifice style and spacing comply with these requirements.

## Section B-8.6. LFH At-grade Treatment Systems

### B-8.6.1. LFH At-grade Treatment Systems – Objectives and Design Standards

#### B-8.6.1.1. General

(1) See graphics for LFH At-grade.

Figure: LFH At-grade General View

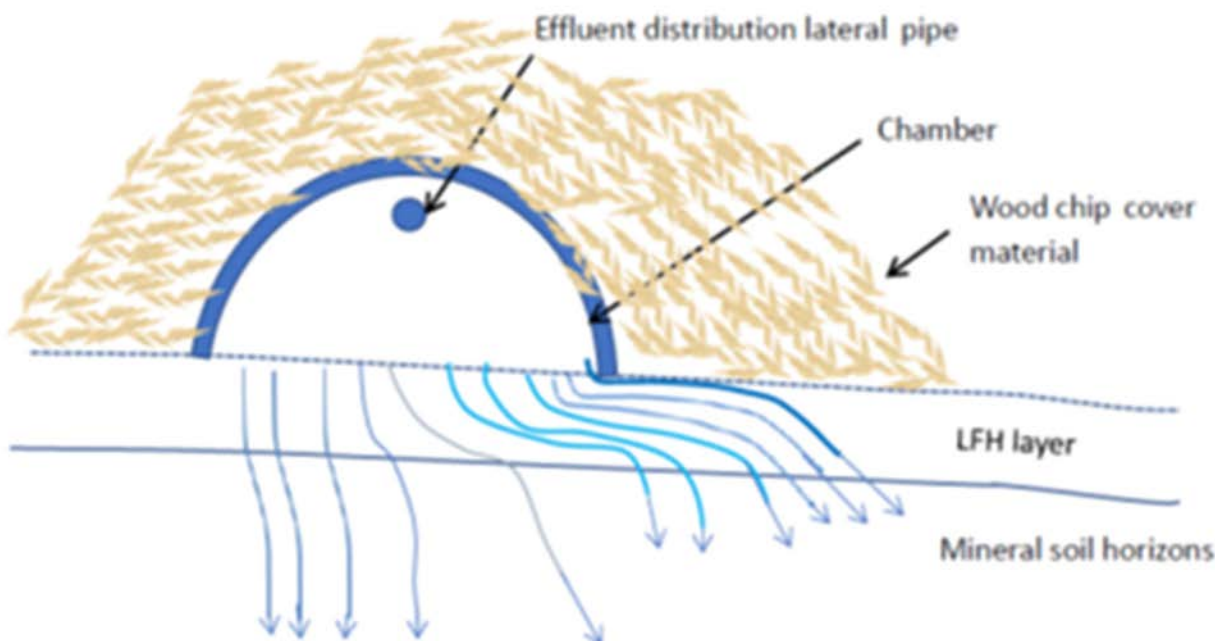

Effluent delivery line should be installed on the upslope side of the LFH At-grade to avoid soil disturbance on the downslope soil treatment area. Delivery line could be installed from the end provided the pressure distribution layout allows.

Deflection of curve is limited to 15% of the length of the LFH At-grade to minimize downslope effluent concentration.

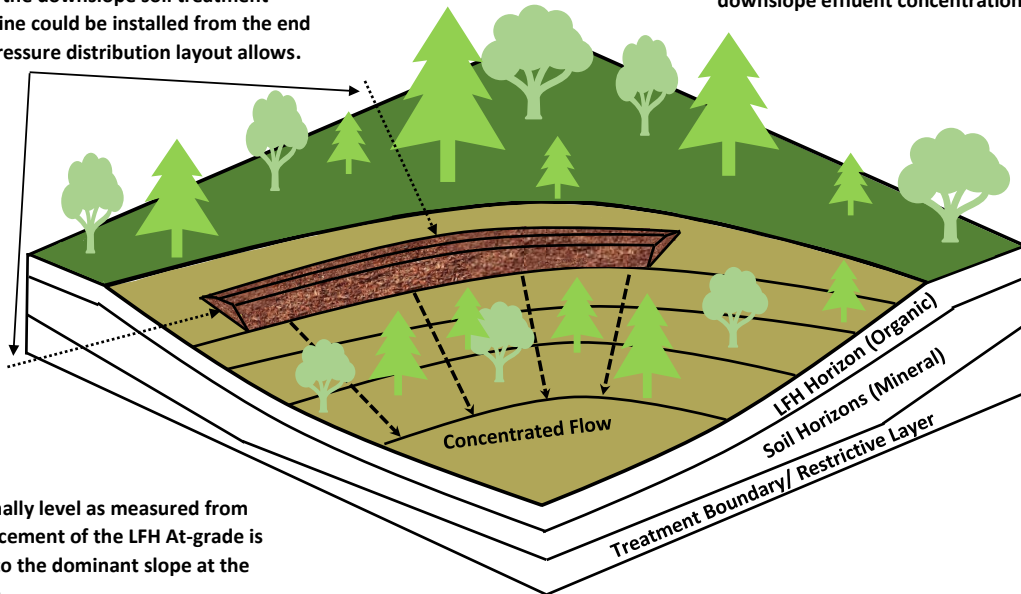

**LFH At-grade**  
 Installed nominally level as measured from end to end. Placement of the LFH At-grade is perpendicular to the dominant slope at the installation site.

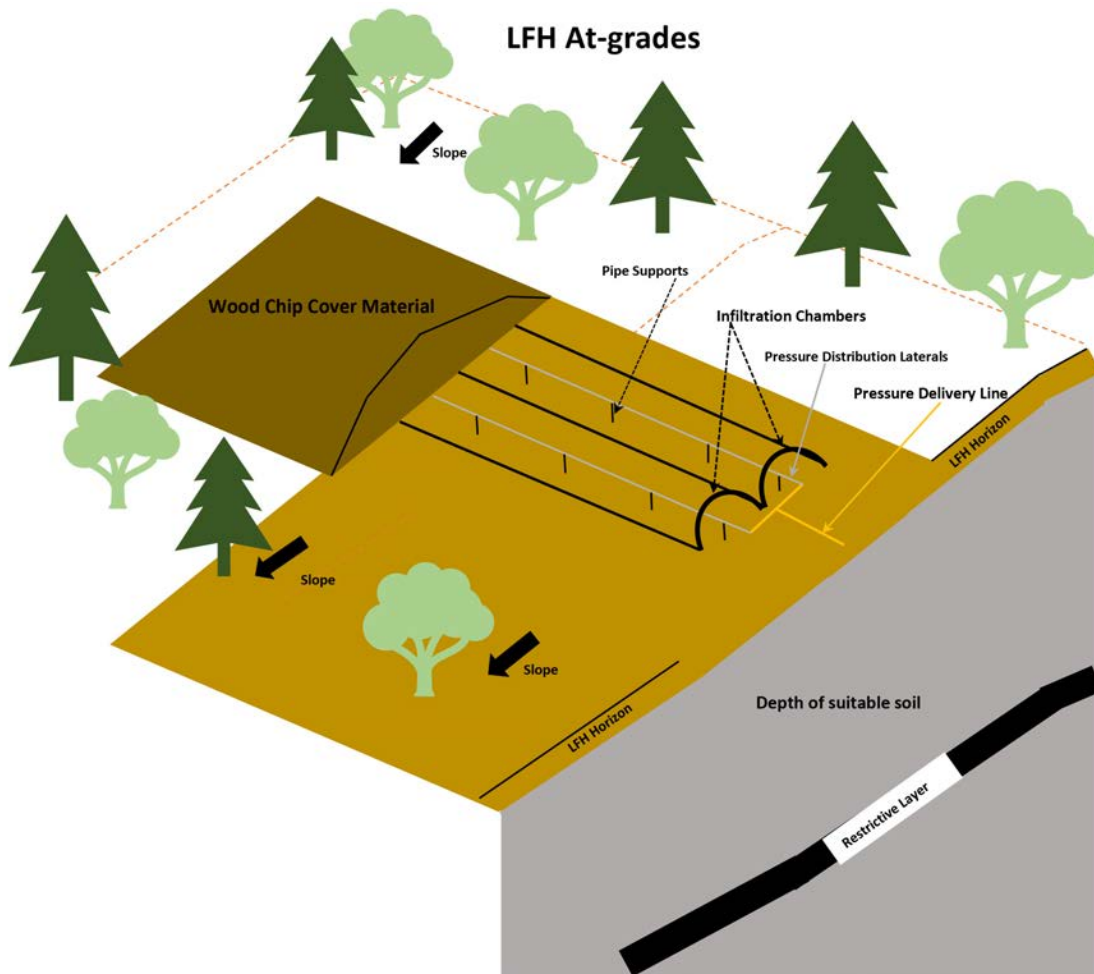

#### B-8.6.1.4. Located in Forested Area

(1)(b) LFH At-grades can be selected as final *soil based treatment systems* in forested areas. Forested areas will have a minimum 50 mm (2 in.) LFH horizon. The LFH horizon is an organic horizon that is different from the *soil* mineral horizons encountered with other *soil* based treatment systems. The LFH horizon is described in descending order. The 3 distinguishable layers of the organic LFH horizon are described below:

- L = litter layer; the leaves and twigs that have fallen to the ground are easily distinguishable, very little breakdown has occurred.
- F = Fermented; Decomposition of plant material is apparent, but the origins of plant residues are still distinguishable. Often, roots are present.
- H = humic; Well-humified plant material to the point where plant residues are not recognizable, with the exception of some roots or wood. This material is in advanced stage of humification in which fine substances predominate over plant residues.

The H layer is not to be confused with the A *soil* mineral horizon. It can be difficult to distinguish between organic and mineral *soil* horizons. The H layer tends to feel very greasy with little or no grittiness; which is due to the layer being composed of organic material and not *soil* mineral material. The A horizon can be identified by an increase in grittiness; as this is a *soil* mineral horizon and not an organic horizon. As the LFH horizon is located at the ground surface, and the horizon is composed of organic material overlying *soil* mineral material, it is essential minimum disturbance and compaction of the site occurs during the installation process. A well-formed LFH horizon is key to the success of the LFH At-grade. See the picture below that shows the LFH layers overlying the *soil* mineral horizons.



Photo courtesy of Kent Watson ©

**B-8.6.1.5. Cover Material and Stability**

1) The cover material most commonly used is wood chips/bark mulch as they provide the needed insulation, oxygen transfer and protection, while meeting the requirement of consistency with the ecology of the forested area. Sawdust and wood planning byproduct is not an acceptable material.

Check with the *authority having jurisdiction* for any restrictions on importing cover material.

The initial depth of cover must be such that as the wood chips/bark mulch settle over time, a minimum cover of 23 mm (9 in.) is maintained. Recommended minimum initial cover at installation is 460 mm (18 in.)

**B-8.6.1.5. Cover Material and Stability**

(3) Coconut matting or other natural, organic *berm* control matting may be used to stabilize the wood chip cover. See graphic below for organic and decomposable material.



**B-8.6.1.7. Time Controlled Pressure Distribution of Effluent Required**

(1) See graphic below for further explanation on *LFH At-grade systems* with timed dosing.

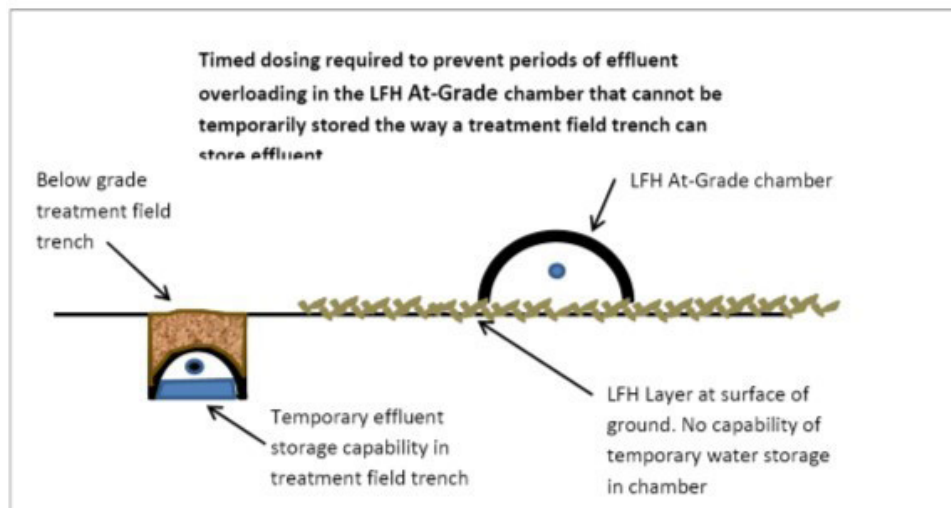

B-8.6.1.8. System Geometry and Linear Loading Rate Design.

(1) See graphics below for *linear loading* flow pattern on a sloped site.

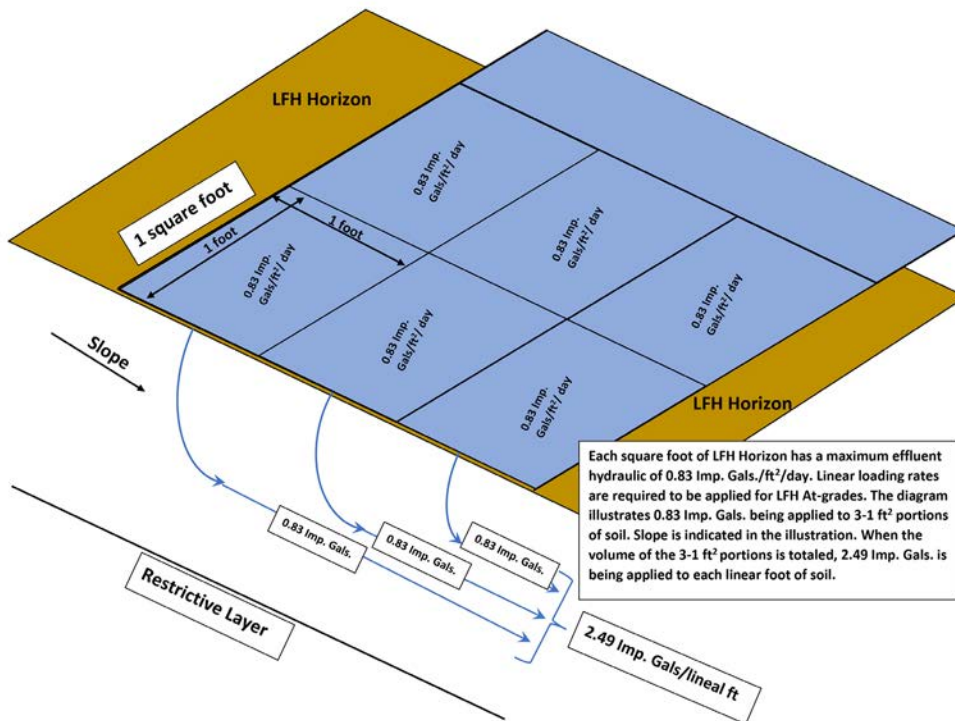
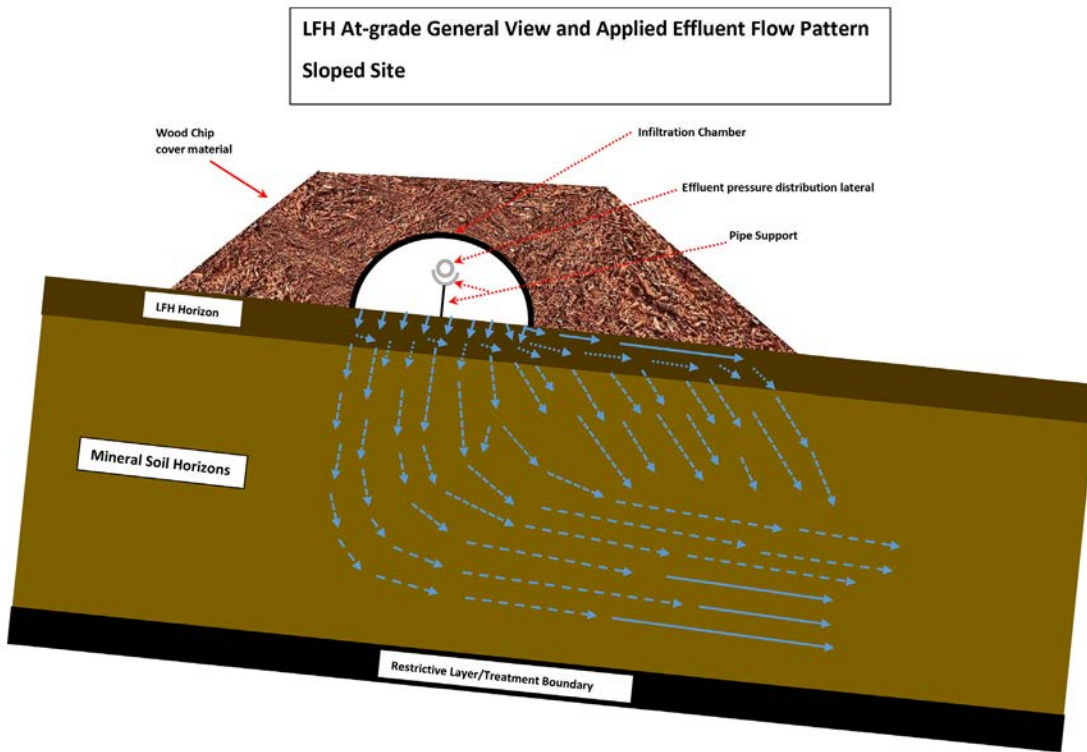

**B-8.6.2. LFH At-Grade Treatment Systems – Prescriptive Requirements and Installation Standards**

**B-8.6.2.4. Design for 5 Individual Doses Per Day**

(1) The inability of the LFH system to temporarily store dosed *effluent* as discussed previously, is the driver for requiring small individual doses and for time dosing being used to spread the doses over the entire day.

**B-8.6.2.5. Cover Material Depth, Slope and Stabilization**

(3) See Graphic Below for further explanation of woodchip *berm* slopes with and without erosion protection.

**Woodchip Berm**

No Erosion Protection @ 1:2 Slope

(1 vertical to 2 horizontal)

Erosion Protection @ 1:1 Slope

Both Slopes Are Minimum

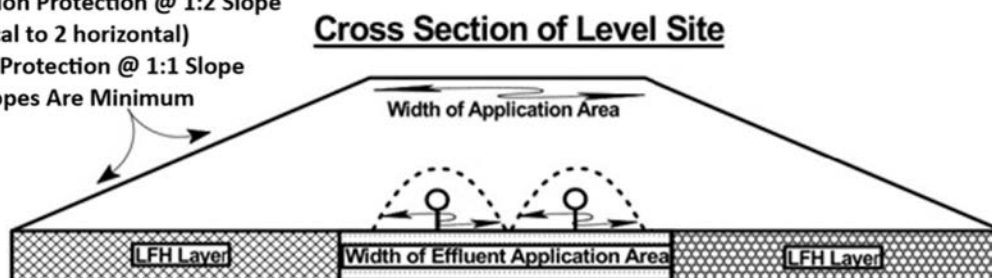

**B-8.6.2.7. Effluent Monitoring Access Ports**

(1) See graphics on monitoring ports for *LFH At-grade systems*.

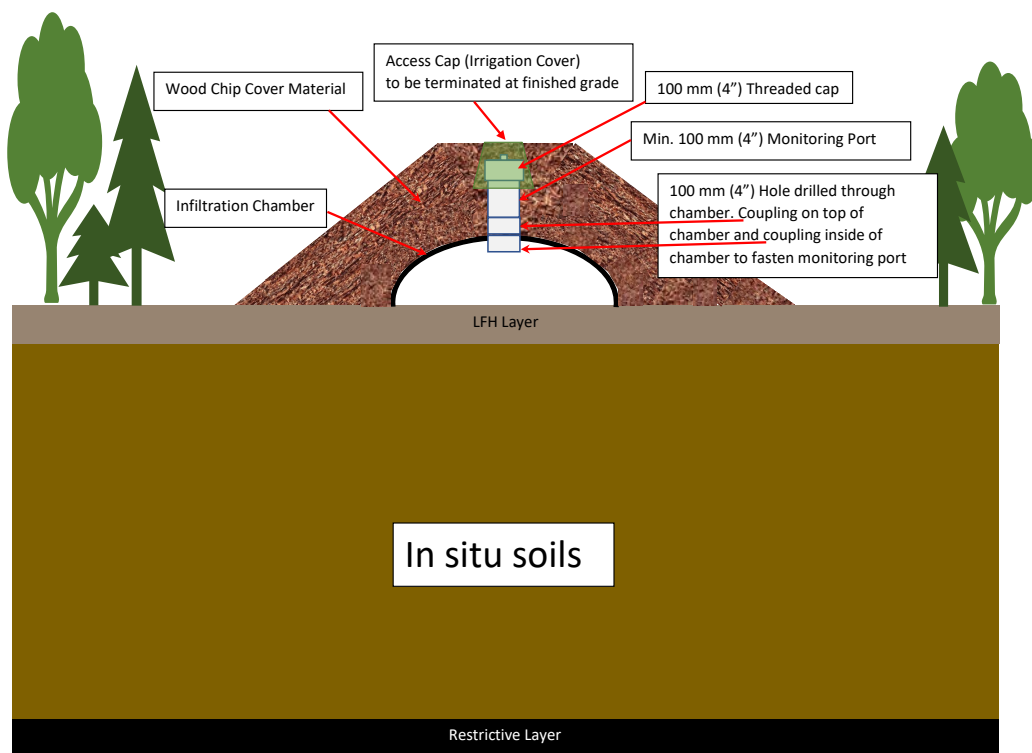



## B-8.7.2. Open Discharge – Prescriptive Requirements and Installation Standards

### B-8.7.2.1. Separation Distances

(2) It is not acceptable to bring the discharge pipe above ground where separation distances are not met and then use surface piping to meet separation requirements.

### B-8.7.2.2. Open Discharge Prohibited

(1) See graphic below for further discussion on this Article

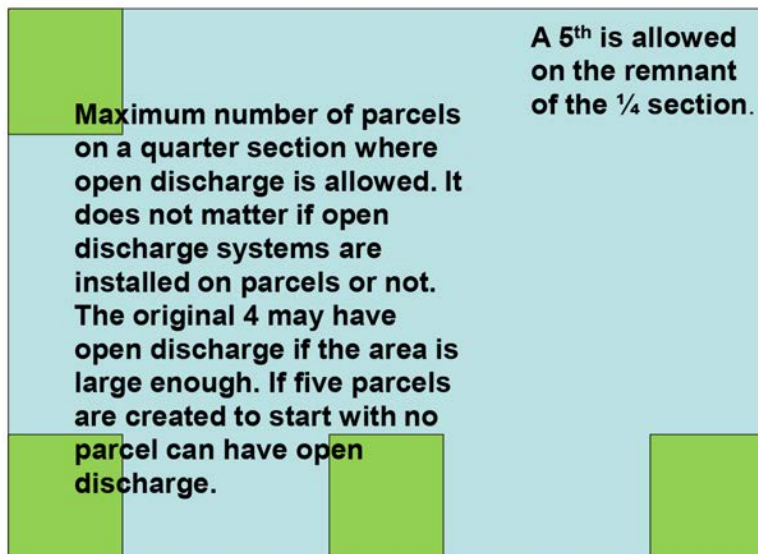

### B-8.7.2.3. Multiple Discharge Systems

(2) The effectiveness of an *open discharge system* is limited as the volume of *sewage effluent* increases. The open discharge is intended as a method for individual residences in agricultural settings at a low *development density*. In some situation, there may not be defined property lines but there are a number of homes served by open discharge systems. The density of the systems is limited by the treatment capacity of the *open discharge system*. This Article limits the density of *open discharge systems*.

## Explanations & Related Articles for Part 10 Privies

### B-10.1.1. Privies – Objectives and Design Standards

#### B-10.1.2.2. Restrictions on Receiving Water-carried Wastes

(1) *Wastewater* discharged to an earthen pit privy can cause the contaminants to travel further though the *soil* as compared to the essentially solid waste typically deposited in a privy. A privy receiving strictly human waste without additional water can be an effective composting unit.



Safety Codes Council - 500 10405 Jasper Avenue, Edmonton, Alberta Canada, T5J 3N4  
(780) 413-0099 1-888-413-0099 fax (780) 424-5134 1-888-424-5134  
[www.safetycodes.ab.ca](http://www.safetycodes.ab.ca)